

McKinsey&Company

MCKINSEY GLOBAL INSTITUTE

REINVENTING CONSTRUCTION: A ROUTE TO HIGHER PRODUCTIVITY

FEBRUARY 2017

IN COLLABORATION WITH
MCKINSEY'S CAPITAL PROJECTS & INFRASTRUCTURE PRACTICE



MCKINSEY
GLOBAL
INSTITUTE

RESEARCH.
INSIGHT.
IMPACT.



MCKINSEY GLOBAL INSTITUTE

Since its founding in 1990, the McKinsey Global Institute (MGI) has sought to develop a deeper understanding of the evolving global economy. As the business and economics research arm of McKinsey & Company, MGI aims to provide leaders in the commercial, public, and social sectors with the facts and insights on which to base management and policy decisions. For the second year running, The Lauder Institute at the University of Pennsylvania ranked MGI the number-one private-sector think tank in the world in its annual 2016 Global Go To Think Tank Index.

MGI research combines the disciplines of economics and management, employing the analytical tools of economics with the insights of business leaders. Our “micro-to-macro” methodology examines microeconomic industry trends to better understand the broad macroeconomic forces affecting business strategy and public policy. MGI’s in-depth reports have covered more than 20 countries and 30 industries. Current research focuses on six themes: productivity and growth, natural resources, labor markets, the evolution of global financial markets, the economic impact of technology and innovation, and urbanization.

Recent reports have assessed the economic benefits of tackling gender inequality, a new era of global competition, Chinese innovation, and digital globalization. MGI is led by four McKinsey & Company senior partners: Jacques Bughin, James Manyika, Jonathan Woetzel, and Frank Mattern, MGI’s chairman. Michael Chui, Susan Lund, Anu Madgavkar, Sree Ramaswamy, and Jaana Remes serve as MGI partners. Project teams are led by the MGI partners and a group of senior fellows, and include consultants from McKinsey offices around the world. These teams draw on McKinsey’s global network of partners and industry and management experts. Input is provided by the MGI Council, which coleads projects and provides guidance; members are Andres Cadena, Sandrine Devillard, Richard Dobbs, Katy George, Rajat Gupta, Eric Hazan, Eric Labaye, Acha Leke, Scott Nyquist, Gary Pinkus, Shirish Sankhe, Oliver Tonby, and Eckart Windhagen. In addition, leading economists, including Nobel laureates, act as research advisers.

The partners of McKinsey fund MGI’s research; it is not commissioned by any business, government, or other institution. For further information about MGI and to download reports, please visit www.mckinsey.com/mgi.

McKinsey’s Capital Projects & Infrastructure Practice

McKinsey’s Capital Projects & Infrastructure Practice is a leading adviser on the planning, financing, construction delivery, and operation of infrastructure, energy, mining, real estate, and other large capital projects and portfolios worldwide. We help clients improve on-time and on-budget delivery of major projects and get the most out of existing capital assets. Working alongside owners, developers, contractors, and financiers, we have experience across all markets, asset classes, and stages of the project life cycle. McKinsey provides our clients with a unique combination of strategic advisers, practitioners with deep sector and market knowledge, and senior technical experts with decades of industry experience in design and construction. Over the past five years, we have delivered impact across more than 3,000 engagements, including work on 150 megaprojects collectively valued at more than \$1 trillion. Our unique ability to partner with our clients and drive fundamental change is rooted in our independent perspective, our alignment with client goals, a deep commitment to innovation and impact, and the depth and breadth of our expertise and experience.

REINVENTING CONSTRUCTION: A ROUTE TO HIGHER PRODUCTIVITY

FEBRUARY 2017



Filipe Barbosa | Houston

Jonathan Woetzel | Shanghai

Jan Mischke | Zurich

Maria João Ribeirinho | Lisbon

Mukund Sridhar | Singapore

Matthew Parsons | Philadelphia

Nick Bertram | London

Stephanie Brown | Minneapolis

PREFACE

Construction is a key industry in countries across the world, but one that has struggled to evolve its approaches as other industries have done, and one whose productivity has suffered as a result. Even while other sectors from retail to manufacturing have transformed their efficiency, boosted their productivity, and embraced the digital age, construction appears to be stuck in a time warp. In the United States since 1945, productivity in manufacturing, retail, and agriculture has grown by as much as 1,500 percent; productivity in construction has barely increased at all. This not only represents a lost opportunity for the industry but costs the world economy.

In this report, the McKinsey Global Institute and the McKinsey Capital Projects & Infrastructure Practice examine the root causes of poor productivity growth in the construction industry, explore practical ways to improve the situation, and discuss the beginnings of a shift in parts of the sector toward a system of mass production, standardization, prefabrication, and modularization—a production system—that has the potential to boost productivity by five to ten times, depending on the sector. In the case of industrial and megaprojects, we see the need to move away from a primarily process-driven project system to a more holistic project operating system that has to be in place to turn around the industry's poor current track record on cost, schedule, and predictability. This research builds on previous work by MGI in conjunction with McKinsey's Capital Projects & Infrastructure Practice and explores ways to reinvent the construction industry in order to achieve higher productivity.

This research was led for MGI by Jonathan Woetzel, an MGI and McKinsey senior partner based in Shanghai, and Jan Mischke, an MGI senior fellow in Zurich; and for the McKinsey Capital Projects & Infrastructure Practice by Filipe Barbosa, senior partner in Houston, Texas; Maria João Ribeirinho, a partner in Lisbon; Mukund Sridhar, a partner in Singapore; and Matthew Parsons, a partner in Philadelphia. The project team was led by Stephanie Brown and Nick Bertram, consultants based in Minneapolis and London, respectively, and comprised Julie Bodenmann, Peter Daemen, Annelies Deleersnyder, Tushita Garg,

Ronald Philip, John Reichl, Charles Riesenbergl, Alex Williams, and Dominic Yau.

Many McKinsey colleagues provided helpful input and advice, including Lukasz Abramowicz, Navtez Bal, Jim Banaszak, Jose Luis Blanco, João Pedro Branco, Olivier Cazeaux, Shankar Chandrasekaran, Roberto Charron, Rocco Colasante, Silvia Costa, Olivier d'Hossche, Arlindo Eira Filho, Fabio Ferri, Nicklas Garemo, Joao Goncalves, Jason Green, Davide Gronchi, Tony Hansen, Jeff Hart, TG Jayanth, Ivan Jelic, Priyanka Kamra, Kate Kang, Vikram Kapur, Amit Khera, Jan Koeleman, Mark Kuvshinikov, Antoine Lagasse, Alison Lai, Adi Leviatan, Carsten Lotz, Tim McManus, Parker Meeks, Carlos Mendes, Gerhard Nel, Kevin Nobels, Robert Palter, Prakash Parbhoo, Matthew Parsons, Nikhil Patel, Shannon Peloquin, Frederic Remond, Stuart Shilson, Suveer Sinha, Erik Sjodin, Tiago Sousa, Venkataramamoorthy Sreeramagiri, Gernot Strube, Jordi Suarez, Michael Tecza, Frank von Willert, Simon Webb, Angela Woods, Cathy Wright, Edward Zaayman, Paul Zarba, and Homayoun Zarrinkoub. We would like to thank Simon Williams, co-founder of QuantumBlack, now part of McKinsey, for his input.

For their input and insightful discussions with us, many thanks go to Ken Simonson, chief economist of Associated General Contractors of America; James Cameron, executive director, Australian Construction Industry Forum; Cesar Ramirez Martinell at Barcelona Housing Systems; Cameron Ng, deputy director, Construction Productivity and Quality Group in the Building and Construction Authority of Singapore; Luís Fernando Melo Mendes, economist, CBIC (Brazilian Chamber of the Construction Industry); Anthony Chia, Chia Ngiang Hong, and Poh Wei Jun at City Developments Limited, Singapore; Arlan Collins, principal and co-founder at CollinsWoerman; John Borcherding, Stephen Mulva, Jean-Pierre Liebaert, and David Lanove of Confédération Construction, Belgium; Daniel Oliveria and Robert Ritter at the Construction Industry Institute; Alice Leung, VDC technology and process manager at DPR Asia Pacific in Singapore; Pierre Anjorlas, president of Eurovia; Gregory A. Howell, co-founder

and former president of the Lean Construction Institute; Joseph Hubback, strategy director of the Keller Group; David Scott, lead structural director of the engineering excellence group at Laing O'Rourke; Angela Middleton, CEO of MiddletonMurray; Paul Emrath, vice president for survey and housing policy research at the National Association of Home Builders; Martin Loosemore, professor of construction management at the University of New South Wales; Ali Touran, professor, civil and environmental engineering, Northeastern University; Peter N. Gal, OECD Economics Department; Jerry Klanac, managing director, PMA Consultants; Rob Shed, executive director of Robshed Consulting, formerly of Carillion Canada; Simon Rubinsohn, chief economist, and Alan Muse, global director of Built Environment Professional Groups at the Royal Institution of Chartered Surveyors; Ofer Kotler, CEO of Shikun & Binui; Wang You-song, professor, department of civil engineering, South China University of Technology; Paul Teicholz, professor of civil and environmental engineering (research), emeritus, Stanford University; Todd Zabelle, founder and president of Strategic Project Solutions; Rick Osterhout, executive vice president, and Don Reid, advisory board member, at Sustainable Living Innovations; Digby Christian, director of integrated project delivery, and James Pease, regional manager, at Sutter Health; José Fernández-Solís, associate professor at the College of Architecture of Texas A&M University; James D. Mildenberger, economist at the US Bureau of Labor Statistics; Glenn Ballard, director, Project Production Systems Laboratory, University of California, Berkeley; and Richard Westney, founding partner, Keith Dodson, partner, and Justin Dahl, principal, at Westney Consulting Group.

We would like to thank MGI senior editor Janet Bush; MGI's Rebeca Robboy and the Capital Projects & Infrastructure Practice's Holly Skillin for their work on external communications and media relations; Julie Philpot, MGI editorial production manager; Marisa Carder, Richard Johnson, Jason Leder, Mary Reddy, Margo Shimasaki, and Patrick White, graphics and data visualization specialists; MGI knowledge operations specialist Timothy Beacom; and Chelsea Grewe and Deadra Henderson in MGI practice management.

We are grateful for all of the input we have received, but the final report is ours, and all errors are our own. This report contributes to MGI's mission to help business and policy leaders understand the forces transforming the global economy, identify strategic locations, and prepare for the next wave of growth. As with all MGI research, this work is independent and has not been commissioned or sponsored in any way by any business, government, or other institution. We welcome your comments on the research at MGI@mckinsey.com.

Jacques Bughin

Director, McKinsey Global Institute
Senior partner, McKinsey & Company
Brussels

James Manyika

Director, McKinsey Global Institute
Senior partner, McKinsey & Company
San Francisco

Jonathan Woetzel

Director, McKinsey Global Institute
Senior partner, McKinsey & Company
Shanghai

February 2017



View of buildings and Emirates Towers in the background in fog
© Momentaryawe.com/Getty Images

CONTENTS

HIGHLIGHTS



Construction's productivity problem



Seven ways to transform productivity



Transformation through a production system

In brief

Page vi

1. Global construction has a productivity problem

Page 15

2. Market failures and industry dynamics

Page 35

3. Seven ways to improve the productivity of construction

Page 61

4. A production system could boost productivity tenfold

Page 115

5. Where and how disruption may play out

Page 127

Technical appendix

Page 143

Bibliography

Page 151

IN BRIEF

REINVENTING CONSTRUCTION

The construction sector is one of the largest in the world economy, with about \$10 trillion spent on construction-related goods and services every year. However, the industry's productivity has trailed that of other sectors for decades, and there is a \$1.6 trillion opportunity to close the gap.

- Globally, construction sector labor-productivity growth averaged 1 percent a year over the past two decades, compared with 2.8 percent for the total world economy and 3.6 percent for manufacturing. In a sample of countries analyzed, less than 25 percent of construction firms matched the productivity growth achieved in the overall economies where they work over the past decade. Absent change, global need for infrastructure and housing will be hard to meet. If construction productivity were to catch up with the total economy, the industry's value added could rise by \$1.6 trillion a year. That would meet about half of the world's annual infrastructure needs or boost global GDP by 2 percent. One-third of the opportunity is in the United States, where, since 1945, productivity in manufacturing, retail, and agriculture has grown by as much as 1,500 percent, but productivity in construction has barely increased at all.
- The new MGI Construction Productivity Survey confirms many reasons for this poor performance. The industry is extensively regulated, very dependent on public-sector demand, and highly cyclical. Informality and sometimes corruption distort the market. Construction is highly fragmented. Contracts have mismatches in risk allocations and rewards, and often inexperienced owners and buyers find it hard to navigate an opaque marketplace. The result is poor project management and execution, insufficient skills, inadequate design processes, and underinvestment in skills development, R&D, and innovation.
- The productivity performance of global construction is not uniform. There are large regional differences, and major variations within the industry. The sector splits broadly in two: large-scale players engaged in heavy construction such as civil and industrial work and large-scale housing, and a large number of firms engaged in fragmented specialized trades such as mechanical, electrical, and plumbing work that act as subcontractors or work on smaller projects like refurbishing single-family housing. The first group tends to have 20 to 40 percent higher productivity than the second. However, even in the more productive heavy construction sector there are endemic—potentially structural—challenges in meeting cost and schedule commitments on megaprojects, and players routinely subcontract specialized trades.
- Examples of innovative firms and regions suggest that acting in seven areas simultaneously could boost productivity by 50 to 60 percent. They are: reshape regulation; rewire the contractual framework to reshape industry dynamics; rethink design and engineering processes; improve procurement and supply-chain management; improve on-site execution; infuse digital technology, new materials, and advanced automation; and reskill the workforce. Parts of the industry could move toward a manufacturing-inspired mass-production system that would boost productivity up to tenfold. Industrial and infrastructure megaprojects need to instill holistic project-operating systems on-site and in design offices. The highly non-linear and challenging nature of megaprojects underscores the difficulty of, and necessity for, moving toward an industrialized project-operating system.
- Many barriers to higher productivity and ways of overcoming them have been known for some time, but the industry has been in deadlock. Most individual players lack both the incentives and the scale to change the system. However, there are forces lowering the barriers for change: rising requirements and demand in terms of volume, cost, and quality; larger-scale players and more transparent markets, and disruptive new entrants; more readily available new technologies, materials, and processes; and the increasing cost of labor with partial restrictions on migrant workers. Construction-sector participants should rethink their operating approaches to avoid being caught out in what could be the world's next great productivity story.

The productivity opportunity in construction



Construction matters for the world economy ... but has a long record of poor productivity

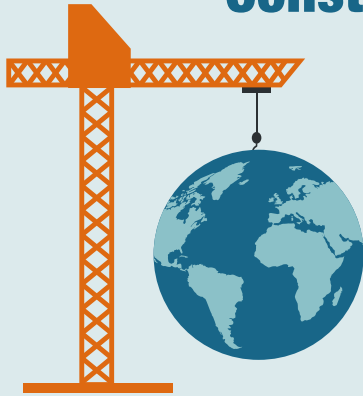

Construction-related spending accounts for

13% of the world's GDP

...but the sector's annual productivity growth has only increased

1% over the past 20 years

\$1.6 trillion of additional value added could be created through higher productivity, meeting half the world's infrastructure need

Construction is a sector of two halves

Fragmented specialized trades drag down the productivity of the sector as a whole

Construction productivity by subsector
Value added per employee, indexed total sector=100, 2013

● % of construction value added

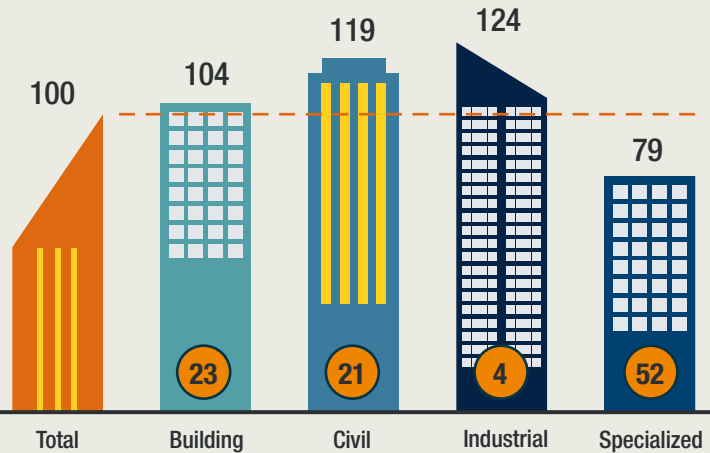

Action in seven areas can boost sector productivity by **50–60%**

- Reshape regulation
- Rewire contracts
- Rethink design
- Improve procurement and supply chain
- Improve onsite execution
- Infuse technology and innovation
- Reskill workers

5–10x productivity boost

possible for some parts of the industry by moving to a manufacturing-style production system

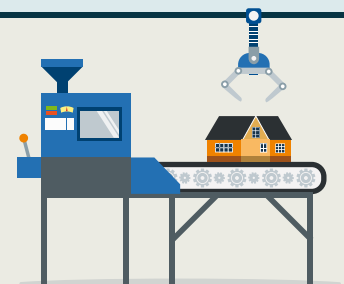



One person with construction helmet looks of a 100-story skyscraper on a 88-story skyscraper in the center of Shanghai
© Steffen Schnur /Getty Images

EXECUTIVE SUMMARY

Every year, there is about \$10 trillion in construction-related spending globally, equivalent to 13 percent of GDP. This makes construction one of the largest sectors of the world economy. The sector employs 7 percent of the world's working population and, by building the structures in which we live and work, which create our energy, materials, and goods, and on which we travel, has an impact well beyond its own boundaries. Construction matters.

However, construction has suffered for decades from remarkably poor productivity relative to other sectors.¹ Other sectors have transformed themselves, boosting productivity. In retail, the mom-and-pop stores of half a century ago have been replaced by large-scale modern retailers such as Aldi and Walmart, with global supply chains and increasingly digitized distribution systems and customer-intelligence gathering. In manufacturing, lean principles and aggressive automation have been transformative. In comparison, much of construction has evolved at a glacial pace.

It is not easy to make assumptions about how productive a sector should be in comparison with others, but global labor-productivity growth in construction has averaged only 1 percent a year over the past two decades (and was flat in most advanced economies). Contrasted with growth of 2.8 percent in the world economy and 3.6 percent in manufacturing, this clearly indicates that the construction sector is underperforming. The United States highlights the industry's challenge. While many US sectors including agriculture and manufacturing have increased productivity ten to 15 times since the 1950s, the productivity of construction remains stuck at the same level as 80 years ago. Current measurements find that there has been a consistent decline in the industry's productivity since the late 1960s.²

If construction labor productivity were to catch up with the progress made by other sectors over the past 20 years or with the total economy (and we show that it can), we estimate that this could increase the construction industry's value added by \$1.6 trillion a year. This is equivalent to the GDP of Canada, or meeting half of global infrastructure needs, or boosting global GDP by 2 percent a year.

Yet despite the substantial benefits that would come from raising the sector's productivity, and despite the fact that the challenges are well known and have long been discussed in the industry, progress has been limited. The industry operates in a way that seems to evolve only very slowly at best, and it is beset with misaligned incentives among owners and contractors and with market failures such as fragmentation and opacity. There is a question around how much the move from "patient capital" toward "quarterly earnings" has affected the industry's ability to invest in itself. Some governments have now begun to address the poor productivity of construction head-on and are attempting to break the deadlock in which the industry appears to find itself. The industry needs a more productive approach—

¹ The McKinsey Global Institute has studied productivity in more than 20 countries and 30 industries, including construction. All reports are available in the productivity, competitiveness, and growth section of www.mckinsey.com/mgi.

² Revisions to labor-productivity metrics in the United States are ongoing; see Leo Sveikauskas et al., "Productivity growth in construction," *Journal of Construction Engineering and Management*, volume 142, issue 10, October 2016. Early indications suggest that changes to measured prices will lead to an increase in measured labor-productivity growth particularly in subsectors such as highways, industrial construction, and homebuilding. This is consistent with patterns we observe in the divergence in productivity development, and level between heavy construction work and specialized trades (subcontracting) and repairs (see Chapter 2). For a discussion of measurement issues relating to construction, see the technical appendix.

demand for construction is rising. And the tools for that more productive approach are increasingly available through digital technologies and new materials.

In this report, we first look at the sector’s poor historical record on productivity and performance, homing in on ten root causes. We then look in some detail at seven ways that, in combination, could improve the productivity of the sector by 50 to 60 percent and estimate the value that could be created with concerted action. We discuss the potential for larger parts of the industry to shift toward a higher-productivity production system in which the bulk of a construction project is built from prefabricated standardized components off-site in a manufacturing facility. In the case of industrial and infrastructure megaprojects, we see the need to move away from a primarily process-driven project system to a more holistic project-operating system in order to improve the industry’s poor current performance on cost, schedule, and predictability. Recognizing and managing variance (plan conformance), flow, and inventory becomes critical. Finally, we explore which parts of the industry may be ripe for disruption and what measures each player might take to make change happen.

CONSTRUCTION HAS AN INTRACTABLE PRODUCTIVITY PROBLEM

Today, around \$10 trillion a year is being spent on the buildings, infrastructure, and industrial installations that are the backbone of the global economy, and demand is rising. By 2025, that amount is projected to total \$14 trillion. However, the industry could produce more for this investment if productivity were higher, leading to a fundamental improvement in the world’s infrastructure and the quality of life of citizens.

Globally, labor-productivity growth in construction has averaged only 1 percent a year over the past two decades, compared with growth of 2.8 percent for the total world economy and 3.6 percent in the case of manufacturing (Exhibit E1).³ In a sample of countries analyzed, over the past ten years less than one-quarter of construction firms have matched the productivity growth achieved in the overall economies in which they work, and there is a long tail of usually smaller players with very poor productivity. Many construction projects suffer from overruns in cost and time.

Exhibit E1

Globally, labor-productivity growth lags behind that of manufacturing and the total economy

Global productivity growth trends¹

— Construction — Total economy — Manufacturing

Real gross value added per hour worked by persons engaged, 2005 \$

Index: 100 = 1995

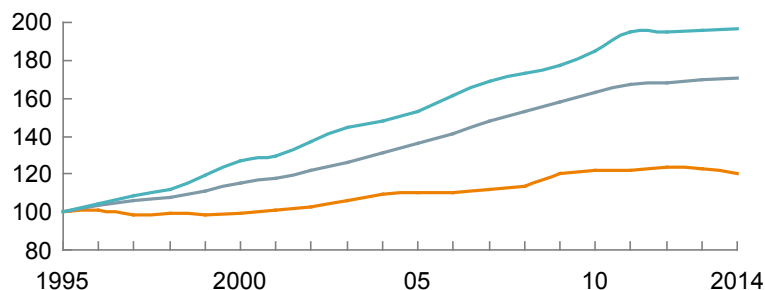

Compound annual growth rate, 1995–2014

%

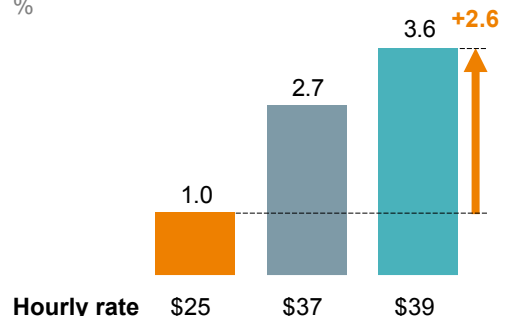

¹ Based on a sample of 41 countries that generate 96% of global GDP.

SOURCE: OECD; WIOD; GGCD-10, World Bank; BEA; BLS; national statistical agencies of Turkey, Malaysia, and Singapore; Rosstat; McKinsey Global Institute analysis

³ Measuring productivity is challenging. We have used gross value added as our measure and used sector deflators to account for price fluctuations. For further detail, see the technical appendix. Our analysis refers to 41 countries that generate 96 percent of global GDP.

The labor-productivity performance of construction sectors around the world is not uniform. There are large regional differences as well as visible pockets of excellence. In the United States, for instance, the sector's labor productivity is lower today than it was in 1968⁴. Indeed, the US construction sector accounts for one-third of the opportunity to boost global productivity identified in this research. Europe's productivity is largely trading water. China and South Africa are increasing their productivity rapidly, albeit from a low base, while countries such as Brazil and Saudi Arabia are falling further behind. A few smaller countries—notably Australia, Belgium, and Israel—are managing to combine high measured productivity levels with comparatively fast growth (Exhibit E2).

Exhibit E2

A small number of countries have achieved healthy productivity levels and growth rates

- Sector productivity growth lags behind total economy
 - Sector productivity growth exceeds total economy
- Size indicates total country construction investment, 2015** 500 \$ billion

Construction labor productivity, 2015¹

2005 \$ per hour worked by persons employed, not adjusted for purchasing power parity²

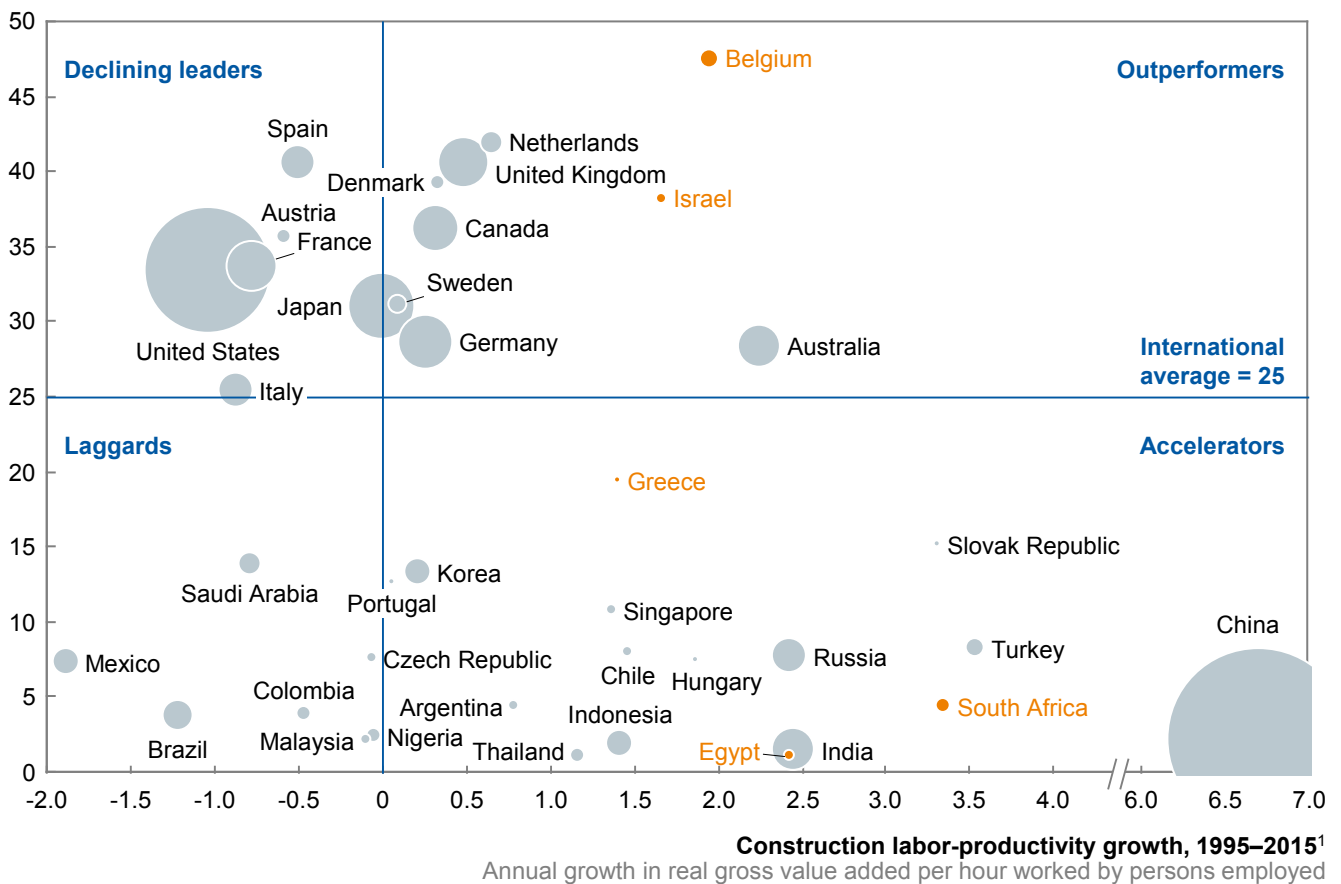

1 Countries with a shorter time series due to data availability: Argentina, Australia, Brazil, Chile, Ethiopia, Japan, Mexico, Nigeria, South Africa (1995–2011); Belgium (1999–2014); China, Colombia (1995–2010); Czech Republic, France, Israel, Malaysia, Russia (1995–2014); Egypt (1995–2012); Indonesia (2000–14); Saudi Arabia (1999–2015); Singapore (2001–14); Thailand (2001–15); and Turkey (2005–15).
 2 Published PPPs are either not applicable (i.e., are not for the construction sector specifically or not for a value-added metric) or vary too widely in their conclusions to lend any additional confidence to the analysis.

SOURCE: OECD Stat; EU KLEMS; Asia KLEMS; World KLEMS; CDSI, Saudi Arabia; Ministry of Labor, Saudi Arabia; WIOD; GGDC-10; Oanda; IHS; ITF; GWI; McKinsey Global Institute analysis

⁴ Leo Sveikauskas et al., "Productivity growth in construction," *Journal of Construction Engineering and Management*, volume 142, issue 10, October 2016.

The low labor productivity of the construction industry is an important issue (see Box E1, “Why labor productivity in construction matters”). If construction sector productivity were to catch up with that of the total economy—and we will show that it can—this would boost the sector’s value added by an estimated \$1.6 trillion, adding about 2 percent to the global economy a year. This would correspond to an increase in construction value added using the same resources of almost 50 percent.

A TALE OF TWO INDUSTRIES: CONSTRUCTION HAS TWO DISTINCT PARTS, EACH OF WHICH IS AFFECTED DIFFERENTLY BY A RANGE OF MARKET FAILURES

The construction sector is not homogeneous. It splits more or less in half between large-scale players engaged in heavy construction such as civil and industrial work and large-scale housing, and a large number of fragmented specialized trades such as mechanical, electrical, and plumbing that act as subcontractors or work on small projects such as single-family housing or, increasingly, particularly in Europe and the United States, refurbishment and repair work. The first group tends to have much higher productivity than the second.

In the first group, contractors involved in industrial infrastructure have, on average, the highest productivity at 124 percent of the figure for the industry as a whole, followed by civil construction players at 119 percent and large-scale building contractors at 104 percent.⁵ Trades subcontractors, which are responsible for a large share of value in small real estate and refurbishment projects, are typically relatively small; their productivity is about 20 percent lower than the sector average. The higher-productivity large-scale half of the industry is not immune to the low productivity of the other half. Large-scale players routinely subcontract to smaller specialized players, and, in the United States, the productivity in civil, industrial, and buildings including trades subcontractors drops by 12, 26, and 28 percent, respectively. Therefore, any action to boost sector productivity needs to apply to the entire supply chain and to both parts of the market—each of which lags behind manufacturing in its productivity (Exhibit E3).

⁵ We calculated construction sector productivity using productivity data for 18 countries: Australia, Canada, the European Union (EU) 15, and the United States. We calculated the average productivity of construction in each country, then indexed that to the total economy level. See the technical appendix for more detail on our methodology.

Box E1. Why labor productivity in construction matters

We focus this report on labor productivity, defined as the value added by construction workers (output in terms of structures created minus purchased materials) per hour of work and its growth over time, adjusted for inflation. An increase means that higher value can be provided to customers with the same or fewer resources, which translates into a desirable mix of higher-quality structures at lower cost for owners, higher profitability for contractors, and higher wages for workers. Any one or two of these objectives can also be achieved without productivity growth—for instance, squeezing wages or margins to lower costs or raising prices for owners to be able to meet wage requirements—but the combination of all three requires productivity growth. High labor productivity often also goes hand in hand with shorter and more reliable schedules.

Exhibit E3

Smaller trades trail on productivity levels and growth

NOT EXHAUSTIVE

US example

- Specialty
- Civil
- Building
- Industrial

Size indicates economic value added, 2012
2015 \$ million



— US construction average

Productivity, 2012

\$ thousand per person employed, 2015 \$

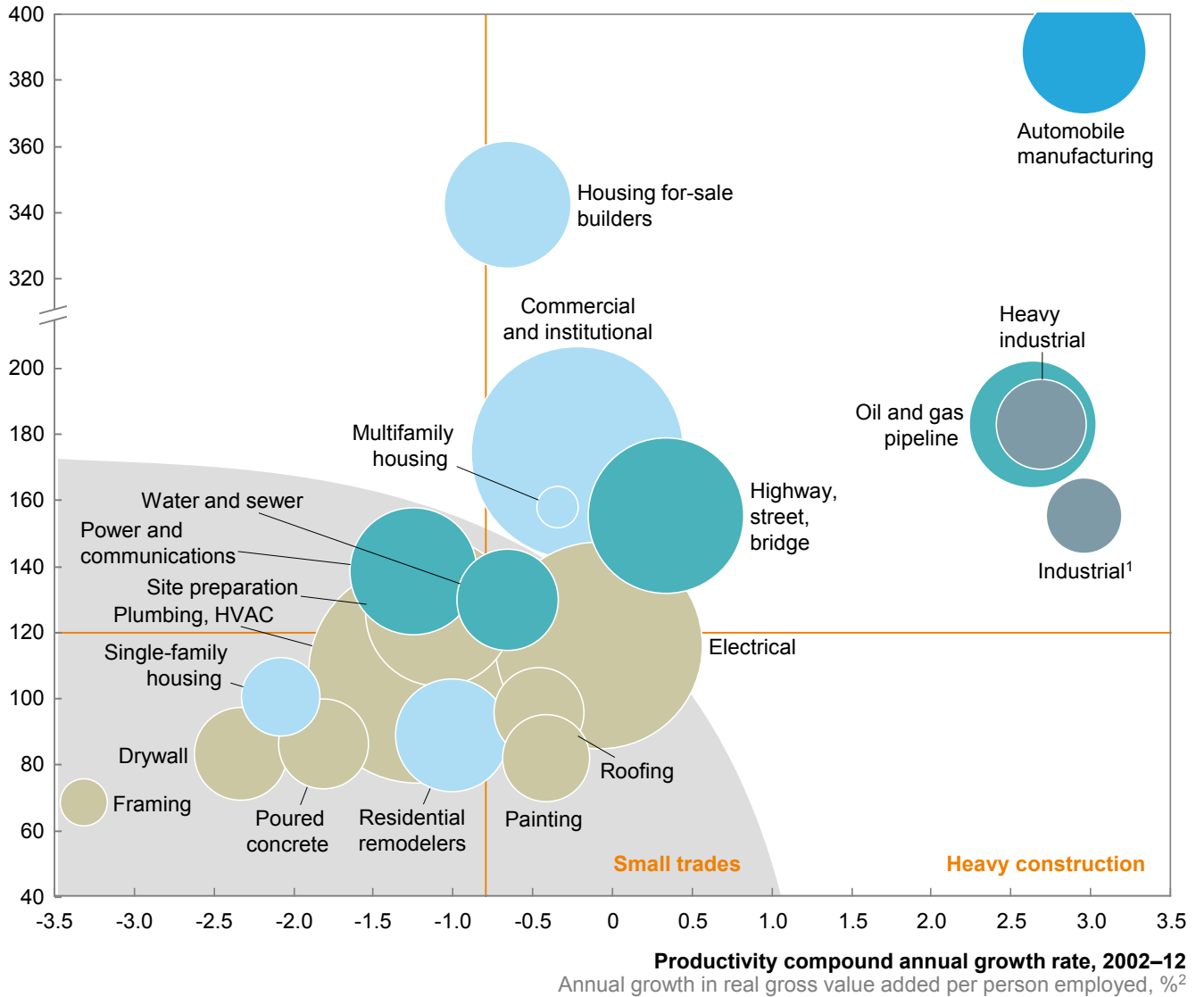

1 Manufacturing plants and warehouses.

2 All subsectors deflated with overall construction sector deflators, not subsector-specific prices.

SOURCE: US Economic Census; McKinsey Global Institute analysis

We identified ten causes of low productivity and market failures in the construction industry (Exhibit E4).

At the macro level, projects and sites are becoming increasingly complex and brownfield-, refurbishment-, or repairs-oriented, and are challenged by geographic dispersion and fragmented land markets. In addition, the construction industry faces extensive regulation and dependency on public-sector demand. Informality, and sometimes outright corruption, distorts the market. Compounding these issues are industry dynamics that contribute to

low productivity—construction is among the most fragmented industries in the world, the contracting structures governing projects are rife with mismatched risk allocation, and owners and buyers, who are often inexperienced, must navigate a challenging and opaque marketplace. The results are operational failures within firms, including inefficient design with limited standardization; insufficient time spent on planning and implementing the latest thinking on project management and execution; and a low-skilled workforce. In addition, the construction industry is highly volatile and has bottom-quartile profit margins compared with other sectors, constraining investment in the technology and digitization that would help raise productivity.

Exhibit E4

We tested ten root causes for low construction productivity

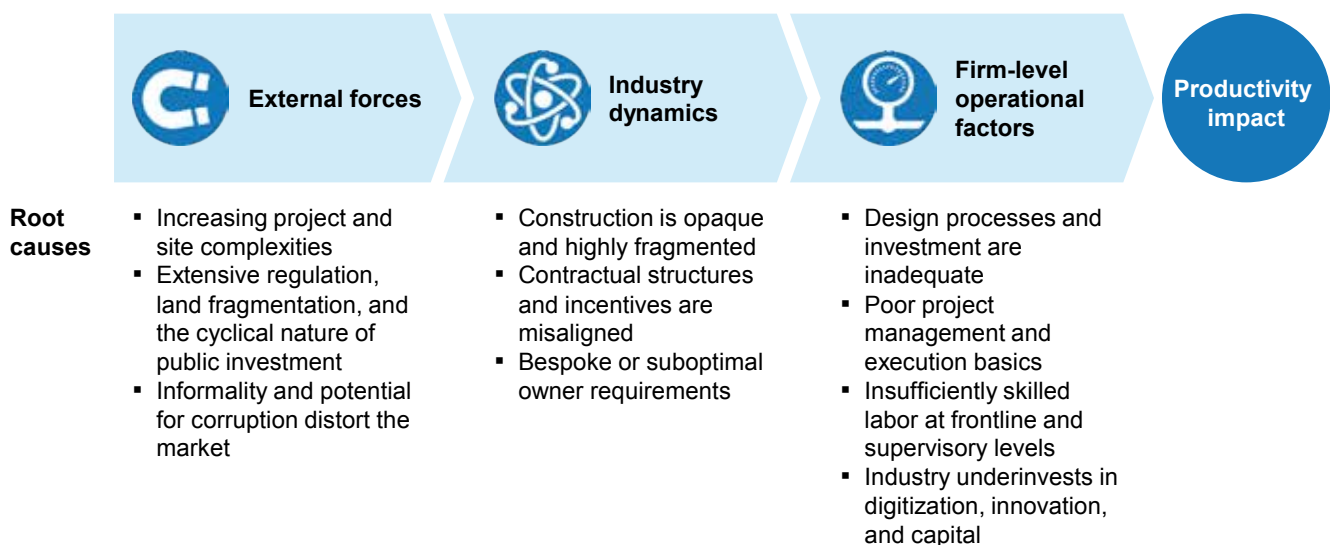

SOURCE: McKinsey Global Institute analysis

The most important market failures and dynamics vary between the two groups. For heavy contractors, suboptimal procurement criteria by public and private owners (focused on reducing initially offered prices and offloading risk) combined with, in some cases, corruption or inexperience among buyers—particularly in the public and residential sectors—have nurtured an environment of misaligned contractual and incentive structures. This has led to hostility and change orders rather than productive and trusted collaboration. The results of a new MGI Construction Productivity Survey confirm this picture of lack of alignment across the industry.⁶ For example, contractors and suppliers identified misaligned contracts as the most important root cause of low productivity, while the top root cause cited by owners was inefficient on-site execution.

Key issues for smaller specialized trade contractors and subcontractors include information asymmetries that reflect the fragmentation of this part of the construction sector, and the geographic dispersion of projects that compromise the cost transparency of projects for owners and make it more difficult for contractors to benefit from scale. Furthermore, small

⁶ Our discussion of the heavy construction part of the industry was informed by a survey administered to 5,000 construction-industry CEOs representing asset owners, engineering and construction firms, suppliers, other institutions such as construction consulting firms, academics, and industry associations such as the Construction Industry Institute. Participants were asked to rank the relative importance of root causes of low productivity and to indicate what their companies were doing to address them. Responses were received from companies active in all regions of the world. See the technical appendix for more detail. For specialized trades, we drew on McKinsey's work in the field as well as a considerable body of MGI research, including country case studies on residential construction. All are available at www.mckinsey.com/mgi.

and specialized trade contractors offering higher-productivity solutions are held back by competition from contractors using less productive but cheaper informal labor and by regulation such as heterogeneous zoning and building codes. Many players in the industry benefit from today's market failures, earning a substantial share of revenue and profits from change orders and claims, and reducing exposure to competition in an opaque market.

THERE ARE SEVEN WAYS TO TACKLE THE TEN ROOT CAUSES THAT UNDERLIE CONSTRUCTION'S POOR PRODUCTIVITY

It doesn't have to be this way. We have identified seven ways innovative companies and regions are addressing current market failures and improving productivity—as well as cost and schedule reliability—in the construction industry. With action and widespread adoption of all seven, the sector's productivity could be 50 to 60 percent higher (Exhibit E5).

Exhibit E5

Construction can catch up with total economy productivity by taking action in seven areas

Cascading effect

Regulation changes facilitate shifts in industry dynamics that enable firm-level levers and impact

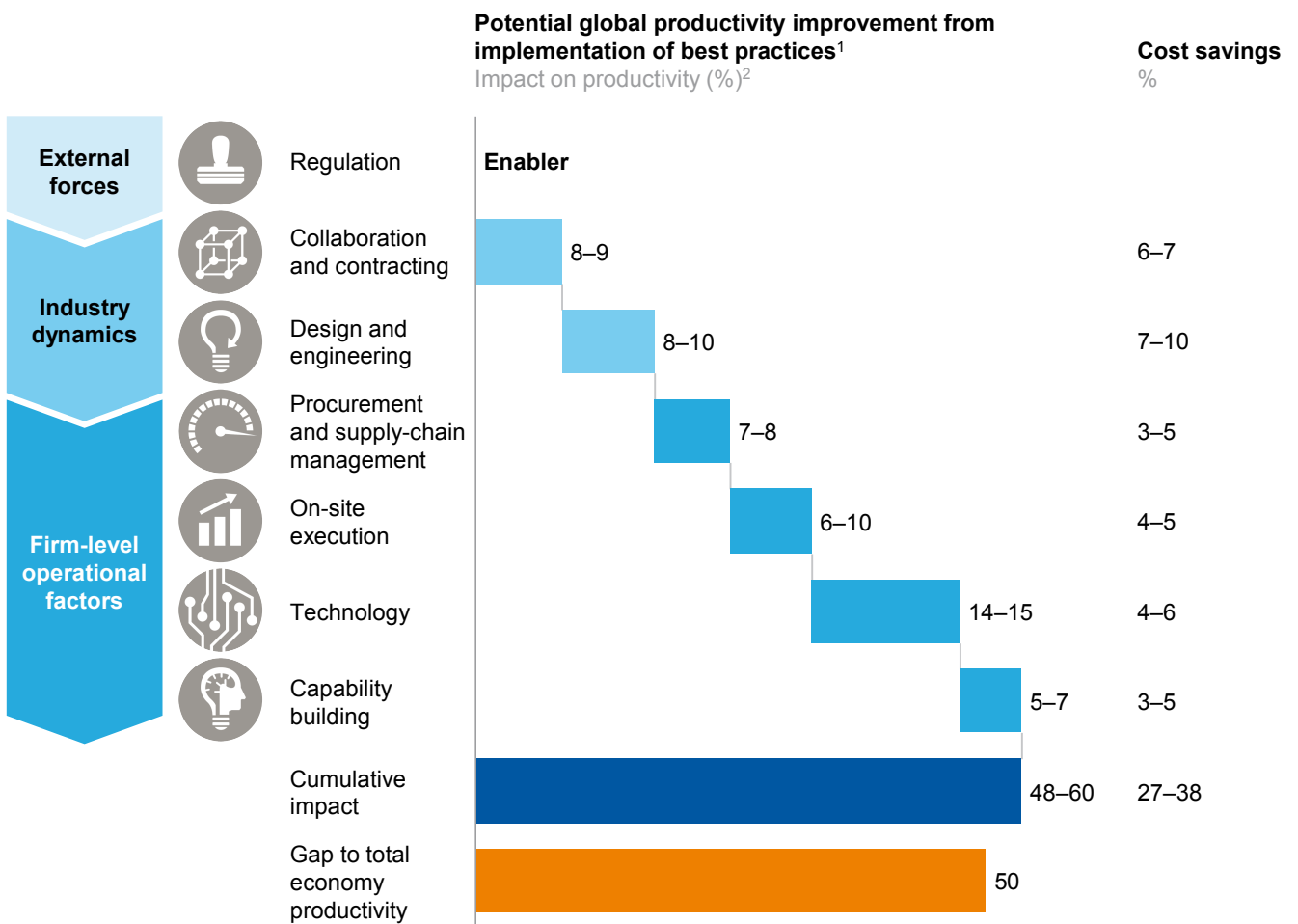

1 The impact numbers have been scaled down from a best case project number to reflect current levels of adoption and applicability across projects, based on respondents to the MGI Construction Productivity Survey who responded "agree" or "strongly agree" to the questions around implementation of the solutions.
2 Range reflects expected difference in impact between emerging and developed markets.

SOURCE: McKinsey Global Institute analysis

Many of the aspects of these seven levers for higher productivity are not surprising, but the industry has not universally applied basic approaches and, even when it has, there is an opportunity to push for best practices:

- **Reshape regulation and raise transparency.** Actions include streamlining permitting and approvals processes, as Australia has done; reducing informality and corruption; and encouraging transparency on cost and performance, as the International Construction Measurement Standards project does.⁷ Many governments allocate grants for innovation and training. Germany’s Federal Ministry of Transport and Digital Infrastructure (formerly the Federal Ministry of Transport, Building, and Urban Development), for instance, supports R&D through studies in building materials. Best-practice regulation would include moving toward outcome-based, more standardized building codes, and consolidating land to promote scale. Examples include Singapore’s move to allow cross-laminated timber (CLT) for high-rise structures and Japan’s promotion of scale through land pooling.
- **Rewire the contractual framework.** There is a need to move away from the hostile contracting environment that characterizes many construction projects to a system focused on collaboration and problem solving. To achieve this, tendering processes can be based on best value and past performance rather than cost alone, and public processes streamlined. Establishing a “single source of truth” on projects for monitoring progress early, potentially supported by collaborative technology, helps to minimize misalignments and enable joint corrective action. The data already exist to fundamentally improve the accuracy of cost and schedule estimates. Where players continue to use traditional contracts, they should introduce incentives that significantly improve performance and alignment not at a trade or package level, but at the project-outcome level. To move toward best practices, appropriate alternative contracting models such as integrated project delivery (IPD) help build long-term collaborative relationships. Relational contracts will need to become more prevalent than transactional contracts. Sufficient investments in up-front planning incorporating all parties’ input have been shown to raise productivity substantially.
- **Rethink design and engineering processes.** Institutionalizing value engineering into the design process with a greater focus on constructability, and pushing for repeatable design elements in those projects that do not require bespoke solutions would make a contribution to boosting productivity. The biggest impact on productivity would come from moving toward thinking about construction as a production system, where possible encouraging off-site manufacture, minimizing on-site construction through the extensive use of pre-cast technology, assembling panels in factories and then finishing units on-site. To indicate the scale of the opportunity, only 50 percent of respondents to the MGI Construction Productivity Survey said that their firms had a standard design library.⁸ In asset classes for which standardization might not be the panacea, the opportunity for parameter specification rather than individual company specifications is significant. Our analysis of sectors such as deepwater oil and gas underscores what a highly significant and largely uncaptured opportunity this is. The automobile and aerospace industries provide insight into how tighter integration with contractors might evolve.
- **Improve procurement and supply-chain management.** A combination of best practices seen in other industries and innovative, digitally enabled approaches can deliver substantial change. Improved planning and increased transparency among contractors and suppliers would reduce delays significantly. Properly skilled central procurement teams can drive economies of scale for certain products across those

⁷ This is a coalition established to develop transparency on costs internationally and the ability to benchmark between them.

⁸ MGI surveyed 5,000 construction-industry CEOs representing asset owners, engineering and construction firms, suppliers, and other institutions such as construction consulting firms, academics, and industry associations. Participants were asked to rank the relative importance of root causes of low productivity, and indicate what their companies were doing to address them. Responses were received from companies active in all regions of the world.

sites. Best practice in areas such as digitizing procurement and supply-chain workflows will enable more sophisticated logistics management and just-in-time delivery. Katerra, for instance, recently launched a data-enhanced global sourcing model to help develop a supply chain that reacts to potential disruptions and market dynamics with predictive replenishment of supplies informed by inventories connected to the Internet of Things (such as wearable devices, radio frequency ID tags, and sensor technology). The construction sector ranks in the lower range of sophistication in the Global Purchasing Excellence Survey published by McKinsey's Procurement Practice, suggesting ample room for improvement.

- **Improve on-site execution.** There are four key approaches that are well known in the industry but have not been universally adopted. First is the introduction of a rigorous planning process—the Last Planner® System (LPS) is a useful tool—to ensure that key activities are achieved on time and on budget.⁹ The use of integrated planning tools on a large-scale oil and gas project, for instance, achieved a 70 percent increase in the project's productivity. Second is reshaping the relationship and interactions between owners and contractors, and key performance indicators (KPIs) being agreed on and used at regular performance meetings at which on-site issues are resolved. Complementing commonly used KPIs with additional forward-looking plan conformance metrics to identify, and subsequently reduce, variance is critical. Third is improving the mobilization for new projects by ensuring that all pre-work (for instance, obtaining approvals and developing project milestones) has been completed prior to starting on-site. Finally, there is a need for careful planning and coordination of different disciplines on-site along with the application of lean principles to reduce waste and variability. At the heart of this issue is a need to move from systems that rely primarily on process and command-and-control toward a more holistic operating system. The sheer complexity and variability of today's megaprojects require a project-operating approach that integrates technical and management systems and fully harnesses workers' capabilities. In the future, new forms of digital collaboration, notably the Internet of Things and advanced analysis, will combine to enable tracking of equipment and materials and therefore greater transparency.
- **Infuse digital technology, new materials, and advanced automation.** Companies can start by making 3D building information modeling (BIM) universal within the company alongside use of digital collaboration tools, drones, and unmanned aerial vehicles for scanning, monitoring, and mapping. They can put themselves at the cutting edge by using platforms such as 5D BIM to establish transparency in design, costing, and progress visualization; advanced analytics enabled by the Internet of Things to improve on-site monitoring of materials, labor, and equipment productivity; and digital collaboration and mobility tools (such as construction management apps loaded on mobile devices) to better track progress and collaborate in real time. On-site productivity can be increased by as much as 50 percent by implementing a cloud-based control tower that rapidly assembles accurate data in near real time that is both backward-looking and predictive (for example, using plan conformance and other variability and inventory metrics). Importantly, owners need to ensure that the right data flow through the various owner, contractor, and subcontractor systems. Big data also has a significant role to play. Techniques and data that are readily available today can produce large improvements in the accuracy of cost and schedule estimates as well as engineering productivity. Developing new lightweight materials and construction methodologies such as prefabricated pre-finished volumetric construction can further facilitate off-site fabrication. Advanced automated equipment and tools such as bricklaying and tiling robots can accelerate on-site execution. The introduction of predictive analytics and

⁹ Registered to the Lean Construction Institute.

pattern recognition has enabled far more sophisticated monitoring of construction projects; one example is the network of sensors installed to track the impact of tunneling works for London's Crossrail project. MGI's productivity survey indicated that the biggest barriers to innovation by construction companies are underinvestment in IT and technology more broadly, and a lack of R&D processes. Establishing innovation officers can make a difference for technology adoption.

- **Reskill the workforce.** Change in the construction sector cannot be achieved without investment in retooling a workforce that is aging and changing its makeup through migration. Construction firms and workers need to continuously reskill and train to use the latest equipment and digital tools. In the mix should be apprenticeship programs such as the one run by Siemens in the United Kingdom, training frontline workers in core skills that are currently underdeveloped; and increasing stability in the workforce by breaking seasonality and cyclicalities.

THERE IS AN OPPORTUNITY FOR PARTS OF THE CONSTRUCTION INDUSTRY TO MOVE TO A PRODUCTION SYSTEM—AND BOOST PRODUCTIVITY UP TO TENFOLD

The seven areas that need to be addressed can boost productivity on projects by some 50 to 60 percent. However, if construction were to depart from entirely project-based approaches to more consistently employ a manufacturing-like system of mass production with much more standardization and manufacturing of modules and parts in factories off-site, the productivity boost could be an order of magnitude greater.

Examples of firms that are moving to a production system suggest that a productivity boost of five to ten times could be possible. For instance, Barcelona Housing Systems, which builds replicable four-story multifamily buildings, aims to have a full production system in place in 2018 that can build five to ten times more units than traditional construction with the same amount of labor. Finnish industrial company Outotec has stated that its mobile flotation plant for small mines requires 20 percent less capital investment and 30 percent less labor, and is 30 percent faster to install than alternatives. Broad Sustainable Buildings of China, which has erected a 30-story hotel in just 15 days, estimates that its buildings cost 10 to 30 percent less than structures erected in the traditional way. Dramatic time and cost savings reported—or aspired to—by these firms add up to much higher productivity. A broader shift to a production system would negate the majority of market failures that we identify in Chapter 2, simplifying and streamlining the construction ecosystem and making it more efficient.

The shift to a production system will not be possible for the entire sector. For some parts of the industry, the answer is a more effective and efficient project-based system, but many players could embrace a much more radical approach. Construction projects cover a broad spectrum in size and complexity, and change of different forms is possible along the breadth of that spectrum (Exhibit E6).

Construction in the middle of the project-scale spectrum can be dramatically different in a production system

Fragmented
small trades

Heavy
construction

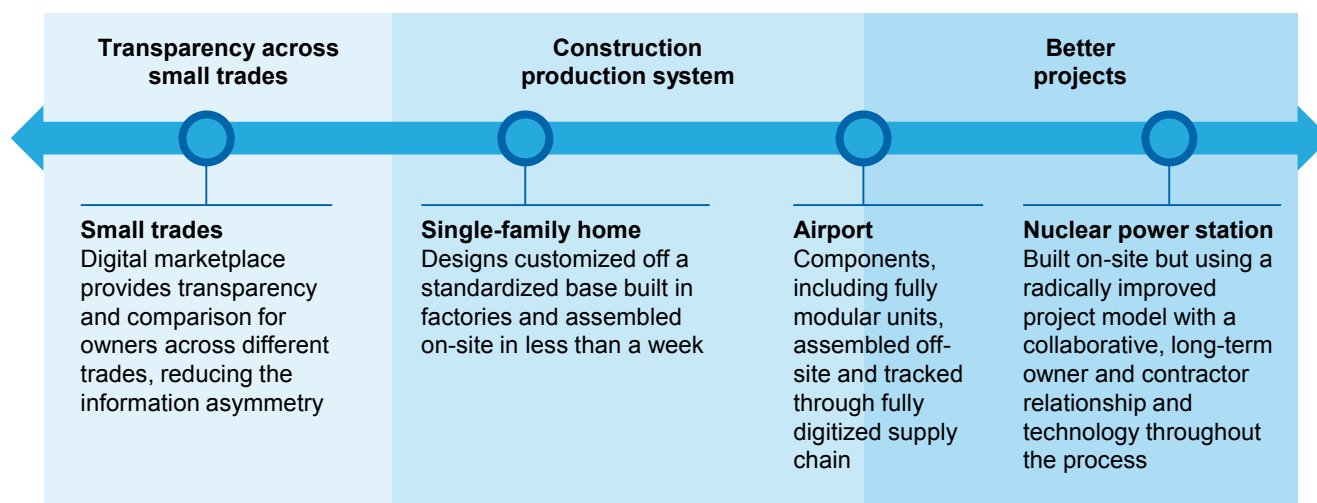

SOURCE: McKinsey Global Institute analysis

WHERE AND HOW MIGHT DISRUPTION PLAY OUT IN THE CONSTRUCTION INDUSTRY?

Today the industry is in deadlock. Owners should be the main beneficiaries of a move to a more productive model but tend to be risk-averse and inexperienced; they need productive contractors that they can trust and that provide them with choice, high quality, and low prices—at scale—before they can change procurement practices and build capabilities for a new paradigm. Many contractors stand to lose revenue and margin from moving to productivity-based competition unless owners and the broader industry environment move, too. A shift to productivity-based competition is only likely to be attractive if contractors can build the scale (and repeatability) needed to drive cost efficiencies from productivity gains that outweigh revenue losses from lower price points and fewer customer claims, and provide payback on up-front and ongoing investments in technology or skill building.

Individual players face a critical strategic question—whether to continue with established business practices or push for change. Even if they opt for the latter, making change happen will require commitment from both owners and contractors.

But now four types of disruption—which have transformed the productivity of other sectors—could help to break the deadlock and usher in a new era of higher productivity:

- Rising requirements and demand in terms of volume, time, cost, quality, and sustainability
- Larger-scale players, more transparent markets, and disruptive new entrants
- More readily available new technologies, materials, and processes
- Rising wage rates and limits on migrant labor

These trends could mean that the potential downside from not moving to a more productive model is more severe, and could increase the potential upside for those who move quickly. The maturity of trends has varied from country to country, with differential impact both on

historical productivity growth and on the potential for an ecosystem that will drive future improvements in productivity (Exhibit E7).

Exhibit E7

The maturity of four trends varies among countries

Impact of driver ■ High ■ Medium ■ Low

		China	Australia	Belgium	Singapore	United Kingdom	United States	Brazil
Trends leading to a potential disruption	Rising requirements and demand in terms of volume/time, cost, and quality/sustainability	High	High	Medium	High	Medium	Medium	High
	Larger-scale players in more transparent markets and disruptive new entrants	High	Medium	Medium	High	Medium	Low	Low
	New technologies, materials, and processes	Medium	Medium	High	High	Medium	Medium	Low
	Rising wage rates, labor shortages, and limitations to migrant labor	Medium	High	Medium	Medium	Medium	Medium	Medium
Government response	Shifts in the regulatory landscape in terms of harmonization and performance orientation	Medium	High	Medium	High	High	Medium	Low
Annual construction productivity growth, 1995–2015		6.71	2.05	1.96	1.37	0.49	-1.04	-1.21
%								

SOURCE: McKinsey Global Institute analysis

The four trends that we have discussed are likely to increase pressure on the industry to change. The potential for change will also be defined by the regulatory environment that supports it. To support productivity growth, regulators can mandate the use of BIM to build transparency and collaboration across the industry; reshape regulations to support productivity; create transparency on cost across the construction industry; publish performance data on contractors; and consider labor interventions to ensure the development of skills instead of relying heavily on a low-cost transient migrant workforce.

If industry players perceive their sector to be amenable to disruption, they need to take account of not only the trends creating that potential disruption but also the regulatory environment. Contractors can introduce a new operating system, invest in technology, and develop a strategic approach. Owners of every type can drive change (although those in the public sector tend to have the scale to drive the biggest impact). They can combine projects into portfolios of work and pipelines of projects to drive cost savings and build scale; and move away from bespoke design for each project.



Change may not be a distant prospect—there are signs of potential disruption in parts of the global construction industry. The diagnostic is well known. Best practices already exist. The potential of a mass-production system offers the chance of a dramatic step change in productivity in some segments of the industry. But the question remains whether the various players in the sector, which have different incentives and challenges, will indeed leave behind the status quo and embrace change that will lead to higher productivity. Many are already doing so; many others will need to follow if the global construction sector is to end decades of inertia and transform itself as other industries have done.

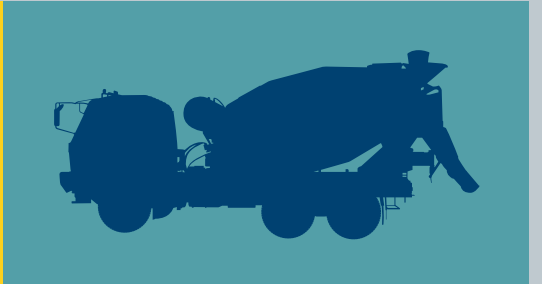
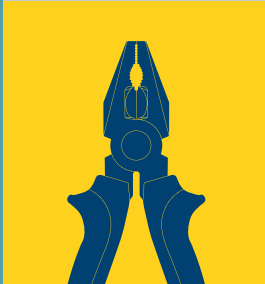
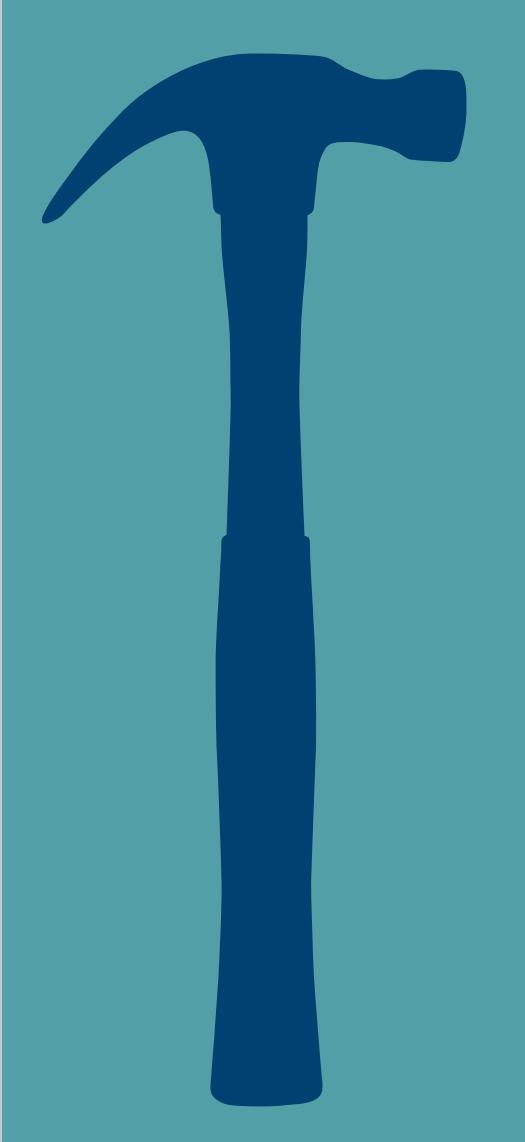
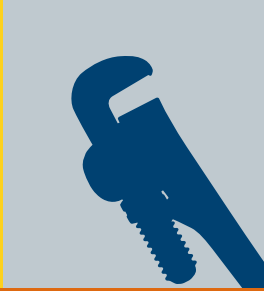
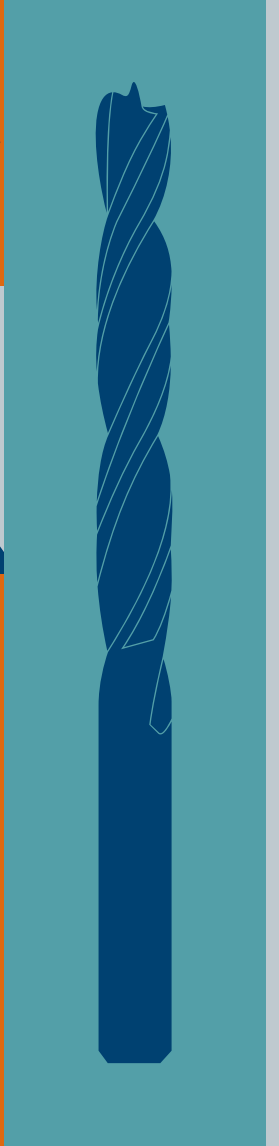
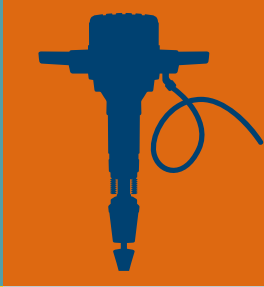



Construction worker carrying and holding shallow pan of construction material on his head
© Pixelfusion3d/Getty Images

1. GLOBAL CONSTRUCTION HAS A PRODUCTIVITY PROBLEM

On the face of it, the construction industry is a growing and dynamic sector. Around \$10 trillion a year is spent on the buildings, infrastructure, and industrial installations that are the backbone of the global economy, and that amount is projected to increase to \$14 trillion in 2025. But the fact is that the industry loses a huge amount of value because of its low labor productivity, a shortcoming that has dogged the industry—whatever the location or stage of economic development—for decades.

Worldwide, labor-productivity growth in the construction industry has averaged only 1 percent a year over the past two decades, compared with a rate of 2.8 percent in the case of the total economy and 3.6 percent in manufacturing. The productivity performance of construction sectors around the world is not uniform. There are large regional differences as well as pockets of excellence. This suggests that there is a viable and achievable opportunity to boost productivity to best-practice levels and to secure large economic benefits. We estimate that if construction productivity could be brought up to the same level as that of the total economy, the industry could generate an additional \$1.6 trillion. This is the equivalent of adding around 110 Crossrails, the new underground line under construction for London, or the GDP of Canada, or boosting global GDP by 2 percent a year.

In this chapter, we look at the sector's historical record on productivity on the global and regional levels and in comparison with other sectors, and we estimate how much output could be raised if the gap with other sectors were to be closed.

CONSTRUCTION-RELATED CAPITAL SPENDING IS NEARLY \$10 TRILLION

Construction-related spending is expected to continue to post the robust growth observed since the end of the global financial crisis, at 3.6 percent a year in the period to 2025, to stand at \$14 trillion (Exhibit 1).¹⁰ The need for construction is ever present. Construction-related spending today is equivalent to 13 percent of global GDP, and it fuels economic activity in a wide range of sectors.¹¹ The US Bureau of Economic Analysis estimated that an additional \$0.86 of economic activity was generated by every \$1 of construction sector GDP in 2012, making it one of the industries with the largest economic spillover effects.¹² The Australian Bureau of Statistics estimates that there is \$2.86 of additional economic benefit for every \$1 of construction GDP.¹³

Three major asset classes make up the capital spending, which together account for all the structures we live and work in. First is the building or real estate sector, which includes residential and commercial real estate as well as social infrastructure like schools, stadiums, and hospitals, and accounts for 62 percent of all construction. Second is civil infrastructure—transportation, power, water, and telecoms—which accounts for 25 percent of the sector. Third is industrial construction, including structures for manufacturing, oil and gas, and mining, which accounts for the remaining 13 percent.

¹⁰ For details on estimates and methodology, see *Bridging global infrastructure gaps*, McKinsey Global Institute and McKinsey's Capital Projects & Infrastructure Practice, June 2016.

¹¹ The 13 percent figure refers to construction-related capital spending, including spending on actual construction as well as capital equipment installed.

¹² *Manufacturing's multiplier effect is stronger than other sectors'*, Manufacturing Institute, 2016.

¹³ The \$2.86 includes an initial \$1 of spending. See *The construction industry's linkages with the economy*, Yearbook Australia, Industry Information Unit, Competitiveness Division, Department of Industry, Science and Resources, Australia, 2002.

Exhibit 1

Construction matters: Construction-related spending accounts for 13 percent of global GDP

\$ trillion

Global GDP

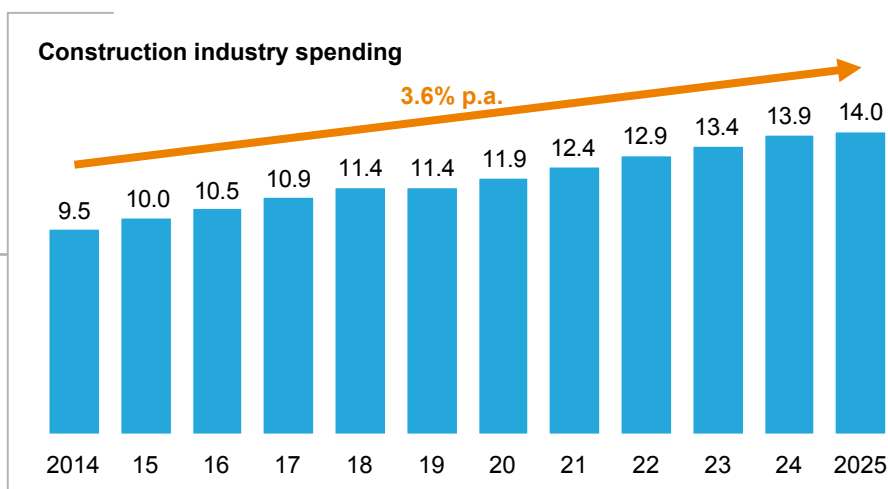
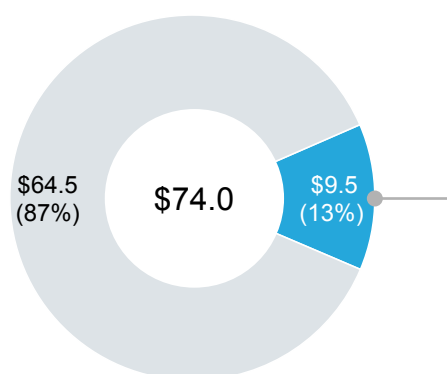

SOURCE: World Bank; IHS; ISSA; McKinsey Global Institute analysis

Growth rates of capital spending vary widely depending on the geography and asset class. In major emerging economies such as China and India, and in regions including Latin America and the Middle East, spending on buildings and infrastructure is a powerful catalyst for commercial and social progress. Spending on real estate and utilities is set to grow at 5 to 10 percent a year in China, India, and the Middle East, fueled by rising incomes that are vaulting millions more into the middle class as well as continuing rapid urbanization.¹⁴ In North America, civil construction will continue to experience strong growth of between 5 and 10 percent, while capital spending on buildings and industrial assets is forecast to be slower, at between 2 and 5 percent. Capital spending growth is projected to be even lower than this in Western Europe, especially in the industrial sector (Exhibit 2).

Spending on construction is highly volatile and sensitive to the growth trajectory of GDP. In developed economies such as the United States, growth in demand for construction output is often 90 percent or more correlated with GDP growth.¹⁵ Expectations about the sector's future output can therefore vary widely depending on different scenarios of global and regional growth. Given its large share of the global construction market, the economic performance of China is likely to have a particularly significant impact on the sector's future. Depending on whether China continues strong growth of about 5 percent to 2030, or moves to a downside scenario of 2.9 percent growth in the long term, we estimate that the size of the sector 15 years out will differ by a factor of two (Exhibit 3).¹⁶ Such large swings in construction activity are not unheard of; in Ireland, construction's share of GDP plunged from 18 percent in 2007 to 8 percent in 2010.

¹⁴ It should be noted that there are large discrepancies in growth forecasts for China's construction sector. Some organizations including IHS and Oxford Economics forecast an 80 to 100 percent increase in the sector's size by 2030. Others, including Morgan Stanley, Bernstein, Berenberg, and Barclays, forecast a 20 to 50 percent decline over the same period. MGI is optimistic on China's prospects, but we present these disagreements to illustrate the extent to which China's development should be viewed with some skepticism. For MGI's latest analysis of China's economy, see *China's choice: Capturing the \$5 trillion productivity opportunity*, McKinsey Global Institute, June 2016.

¹⁵ Jay Berman and Janet Pflieger, "Which industries are sensitive to business cycles?" *Monthly Labor Review*, US Bureau of Labor Statistics, February 1997.

¹⁶ For economic scenarios on China, see *China's choice: Capturing the \$5 trillion productivity opportunity*, McKinsey Global Institute, June 2016.

Exhibit 2

Growth in construction output will be particularly strong in emerging economies, especially in the building and civil segments

Composition of construction market by region, 2013

%

Regional

100% = \$9.0 trillion, 2015 prices

Compound annual growth rate, 2015–25 (%)

<2 2–5 5–10 >10

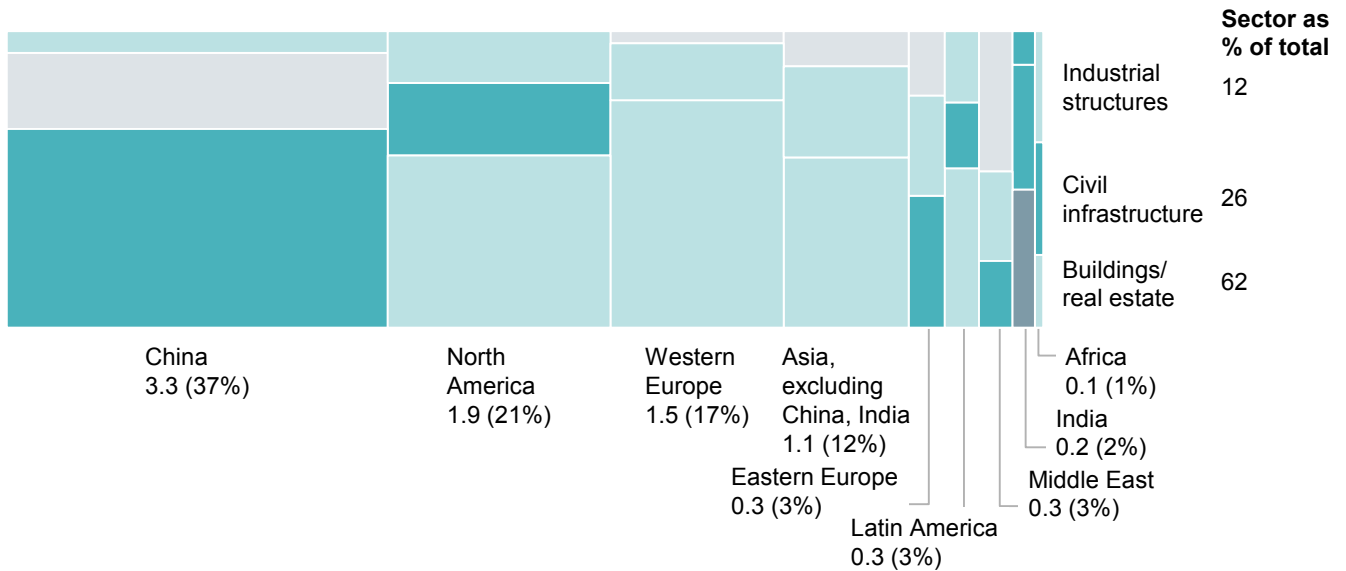

NOTE: Numbers may not sum due to rounding.

SOURCE: IHS; ITF; GWI; World Energy Outlook; MEED; World Bank; African Development Bank; Asian Development Bank; Moody's Analytics; national accounts for Argentina, Brazil, China, India, Indonesia, Nigeria, Russia, Singapore, South Africa, South Korea, and United States; McKinsey Global Institute analysis

Exhibit 3

Different scenarios for China's future growth will have a large impact on construction output

%

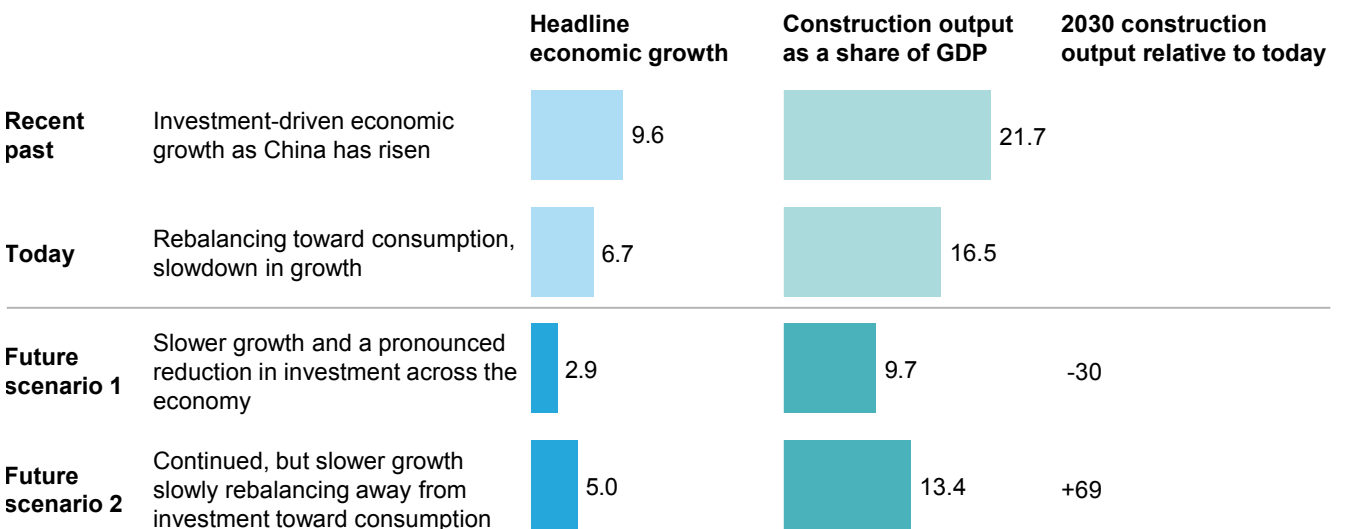

NOTE: Main assumptions: building depreciation = 2.5%; scaling down share of investment as total part of the economy = 20%.

SOURCE: DKM Economic Consultants estimates; McKinsey Global Institute analysis

Not all projected spending will go to construction companies. Owners bear some costs, such as in project management, design, planning, and engineering. Manufacturers of infrastructure equipment such as power turbines and telecoms base stations shoulder other costs. Overall, we estimate that construction companies received around \$7.0 trillion out of the \$9.5 trillion in global construction-related spending in 2015 (Exhibit 4).

Exhibit 4

The global construction sector generates \$3.1 trillion of gross value added to meet \$9.5 trillion of construction-related demand

\$ trillion, 2014

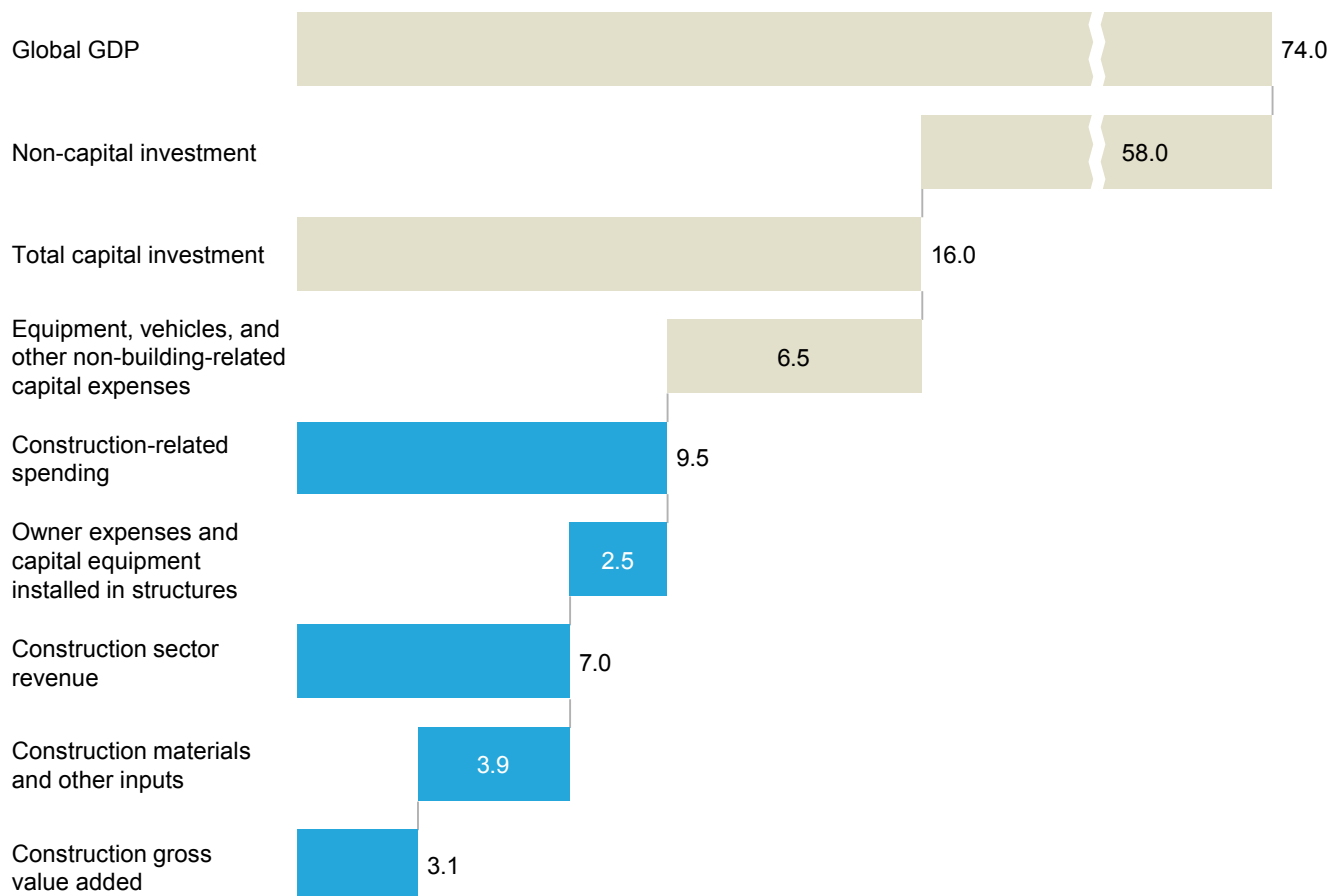

1 Estimated based on 2009 WIOD values, scaled to 2015 using a 3.7 percent compound annual growth rate and adjusted for coverage of investment and global GDP database.

NOTE: Numbers may not sum due to rounding.

SOURCE: World Bank; IHS; ITF; GWI; McKinsey Global Institute analysis

To generate this amount of business, in 2014 the construction sector sourced \$3.9 trillion worth of inputs consisting largely of materials and equipment. In the United States, for example, materials account for about half of total inputs, with equipment accounting for a further 20 percent. Of the materials used, slightly less than one-third is retail and wholesale supplies like lumber, insulation, shingles, nails, and so on. Fuel necessary for machinery and equipment is the second-largest item at 20 percent of total materials. Construction is largely a domestic enterprise. In the United States, more than 85 percent of inputs are sourced from within the country's borders. The remaining 15 percent of international inputs consists almost entirely of imported materials and equipment. Finally, the sector adds

\$3.1 trillion in value in addition to these purchased inputs, consisting of labor inputs and returns to capital.¹⁷ This value added and the labor required to create it are the basis for the productivity analysis in this report.

The construction industry has relatively thin—and volatile—profit margins, which are in the bottom quartile across industries (Exhibit 5). This is an often-cited reason that levels of investment in capital and innovation are lower in construction than they are in other industries. However, the return on invested capital in construction tends to be significantly better than the return on sales, averaging in the midrange of industries.

Exhibit 5

The construction industry has bottom-quartile profit margins

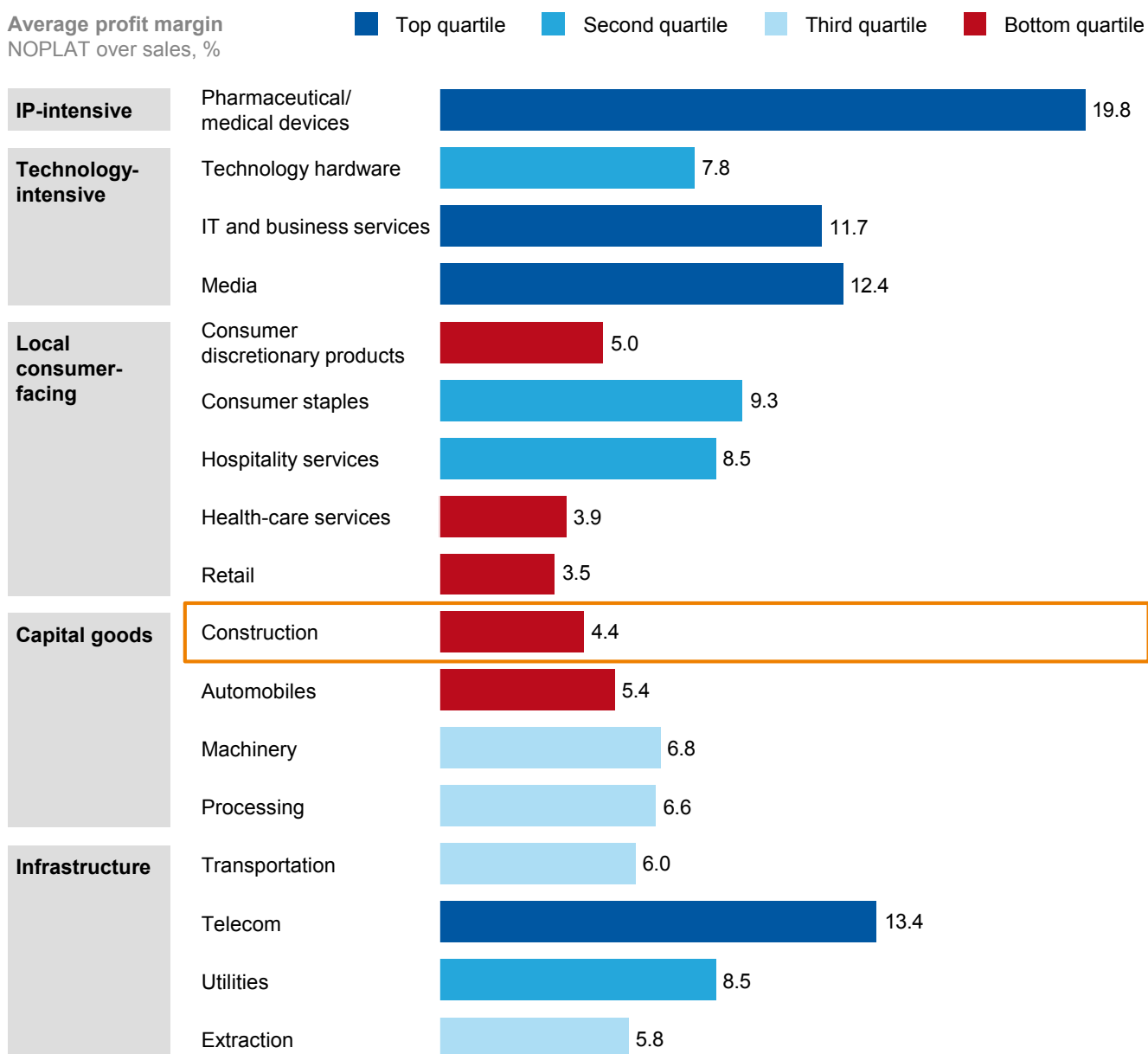

SOURCE: McKinsey Corporate Performance Analysis Tool; IHS; US Bureau of Economic Analysis; US BLS; McKinsey Global Institute analysis

¹⁷ In economic terms, this is referred to as gross value added, which is a significant component of the analysis used throughout this report.

Labor-productivity growth has long lagged behind that of other sectors in almost all countries—but there are pockets of strength

Labor productivity in construction is poor throughout the world—very few countries have construction sectors that outperform the broader economy in growth and absolute terms. We acknowledge that comparing productivity among countries is difficult, but we still think it is a useful exercise (see the technical appendix for a full discussion of data challenges).

We focus on labor productivity in this analysis because construction is such a labor-intensive industry where labor costs account for between 30 and 50 percent of the total cost of a construction project. We demonstrate that capital deepening is a surprisingly weak determinant of productivity (see Box 1, “Weak total factor productivity growth is an even more important drag than the sector’s low capitalization”).

Box 1. Weak total factor productivity growth is an even more important drag than the sector’s low capitalization

This report focuses on labor productivity on three levels:

Economic: Gross value added (the value of outputs such as the final building less the value of inputs such as lumber and concrete) per hour worked

Firm: Earnings before interest, taxes, depreciation, and amortization (EBITDA) plus labor cost (equivalent in financial-statement terms to the economic definition of gross value added) per employee

Project: Operational productivity metrics (for example, yards of concrete poured per hour worked)¹

Construction is a capital-light sector. In developed economies—including Belgium, Japan, and the United States, to take just three examples—the level of capitalization is lower than that of both manufacturing and the total economy average. There is some evidence that this is beginning to change. Capital deepening in the sector is outpacing the total economy average (Exhibit 6). However, there is still a large gap to close. In all the major economies that we studied, the capital-labor ratio rose in real terms from 1995 to 2007, with increases ranging from less than 1 percent per year in Germany to more than 6 percent a year in India.²

It is undeniable that capital plays a role in productivity; data show that construction productivity and capitalization levels are highly correlated. But the causal role is weak. Regressing growth in capitalization against growth in construction productivity reveals almost no relationship. When decomposing labor-productivity growth in several major economies into capital deepening, labor composition changes, and total factor productivity, we find that total factor productivity has been the major driver, with capital deepening and the composition of labor (for instance, changes in skills or the capability of labor arising from greater education or experience) contributing smaller shares (Exhibit 7). For this reason, our discussion of the root causes of low productivity in the construction industry in Chapter 2 focuses largely on how efficiently and intensively labor and capital inputs are used.

¹ We fully acknowledge there are inherent measurement issues in productivity metrics, including a lack of reliable measures of cross-country purchasing power parity, possibly incomplete accounting of undocumented workers, and an imperfect accounting for quality differences. Solving these measurement issues is beyond the scope of this paper. Please see the technical appendix for a full discussion of our definitions of productivity and the associated measurement challenges.

² The countries included in the analysis were Australia, Belgium, Canada, China, Denmark, Germany, India, Japan, the Netherlands, Russia, South Korea, Turkey, the United Kingdom, and the United States.

Box 1. Weak total factor productivity growth is an even more important drag than the sector's low capitalization (continued)

Exhibit 6

The capitalization of construction is lower than that of other sectors but is growing faster than that of the total economy

Capitalization level of various industries

Gross fixed capital per hour worked, 2007
\$, 1995

■ Construction ■ Manufacturing¹ ■ Total economy

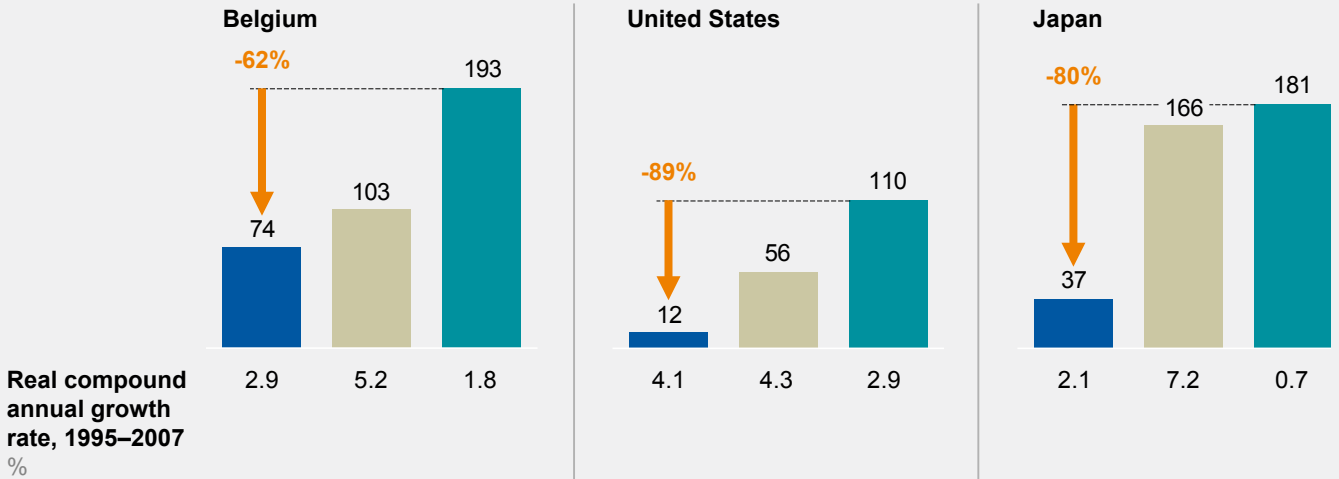

1 Transportation equipment manufacturing, including cars, ships, trains, aircraft, etc.

SOURCE: WIOD; McKinsey Global Institute analysis

Exhibit 7

Capital is a much less important determinant of productivity growth in construction than total factor productivity

Construction sector productivity and value-added growth decomposition

Cumulative contribution to real growth 1978-2010
%

■ Hours worked ■ Total factor productivity¹ ■ Capital ■ Labor composition²

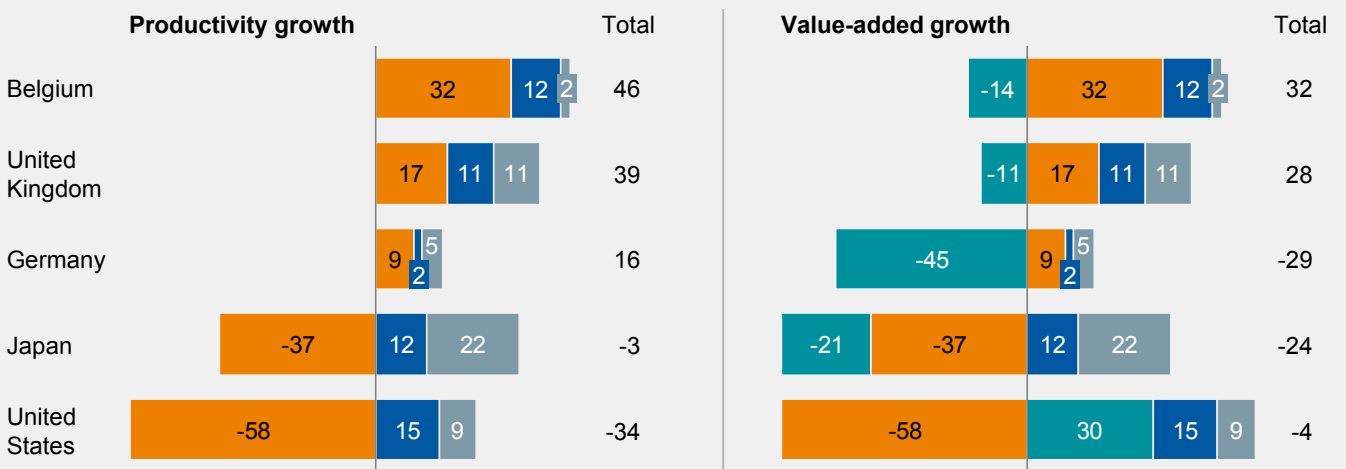

1 The portion of added value not explained by inputs to production; determined by how efficiently and intensely inputs are used.

2 Changes in skills or capability of labor.

NOTE: Numbers may not sum due to rounding.

SOURCE: World KLEMS; McKinsey Global Institute analysis

In aggregate, growth in construction labor productivity in 39 of the world's largest construction economies—representing every continent and stage of economic development—has been a paltry 1 percent since 1995.¹⁸ That is about one-third of the overall productivity growth in these countries of 2.8 percent over the same period, and just over one-quarter of the 3.6 percent achieved by the worldwide manufacturing sector (Exhibit 8).

Exhibit 8

Globally, labor-productivity growth lags behind that of manufacturing and the total economy

Global productivity growth trends¹

— Construction — Total economy — Manufacturing

Real gross value added per hour worked by persons engaged, 2005 \$ Index: 100 = 1995

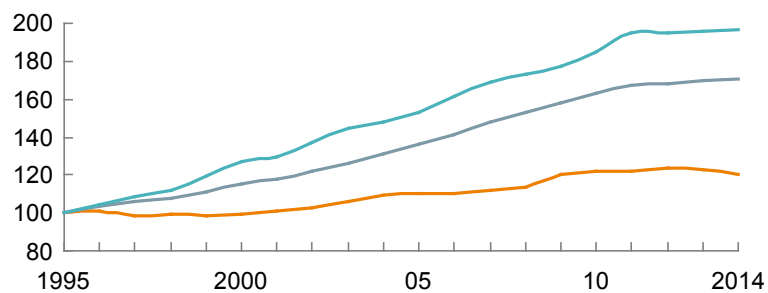

Compound annual growth rate, 1995–2014 %

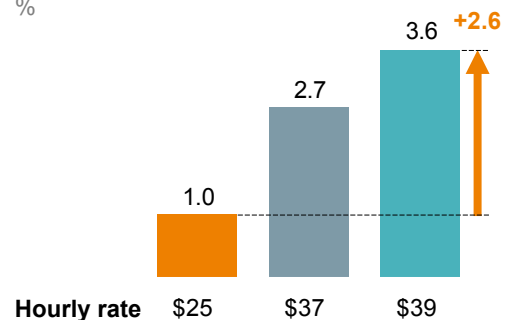

¹ Based on a sample of 41 countries that generate 96% of global GDP.

SOURCE: OECD; WIOD; GGCD-10, World Bank; BEA; BLS; national statistical agencies of Turkey, Malaysia, and Singapore; Rosstat; McKinsey Global Institute analysis

In some countries, the gaps are even wider than the average. In the United States, for example, construction labor productivity has declined by an average of 1.7 percent a year since 1968 while the productivity of the overall economy has grown by 1.6 percent over the same period.¹⁹ Construction lagged even further behind certain sectors that were improving their productivity sharply, including agriculture, which increased its productivity at a rate of 4.5 percent a year between 1947 and 2010, and retail, at a rate of 3.4 percent per year. A differential in productivity-growth rates among sectors of a few percentage points may seem insignificant, but the impact mounts up over many decades (Exhibit 9).

Despite some highly technical and complex projects being undertaken, construction has largely continued to rely on traditional methods for many projects, whereas other sectors have innovated. Other sectors have transformed themselves, boosting productivity. In retail, think of the difference between mom-and-pop stores half a century ago and Walmart and Aldi with their global supply chains and sophisticated—and increasingly digitized—distribution systems and customer-intelligence gathering. Or consider the way lean principles and aggressive automation have utterly changed many parts of manufacturing. In comparison, construction appears frozen in time. To be sure, there are highly technological and complex projects being executed today, but by and large, the sector still relies on traditional methods for many projects, and change is glacial.

¹⁸ Firm-level data point to a similar conclusion. Between 2005 and 2015, the average productivity of the 1,000 largest construction firms in the world was essentially unchanged. The length of time over which reliable project-level metrics exist is too short to reach meaningful temporal conclusions.

¹⁹ Revisions to labor-productivity metrics in the United States are ongoing; see Leo Sveikauskas et al., “Productivity growth in construction,” *Journal of Construction Engineering and Management*, volume 142, issue 10, October 2016.

Exhibit 9

In the United States, labor productivity in construction has declined since 1968, in contrast to rising productivity in other sectors

Gross value added per hour worked, constant prices

Index: 100 = 1947

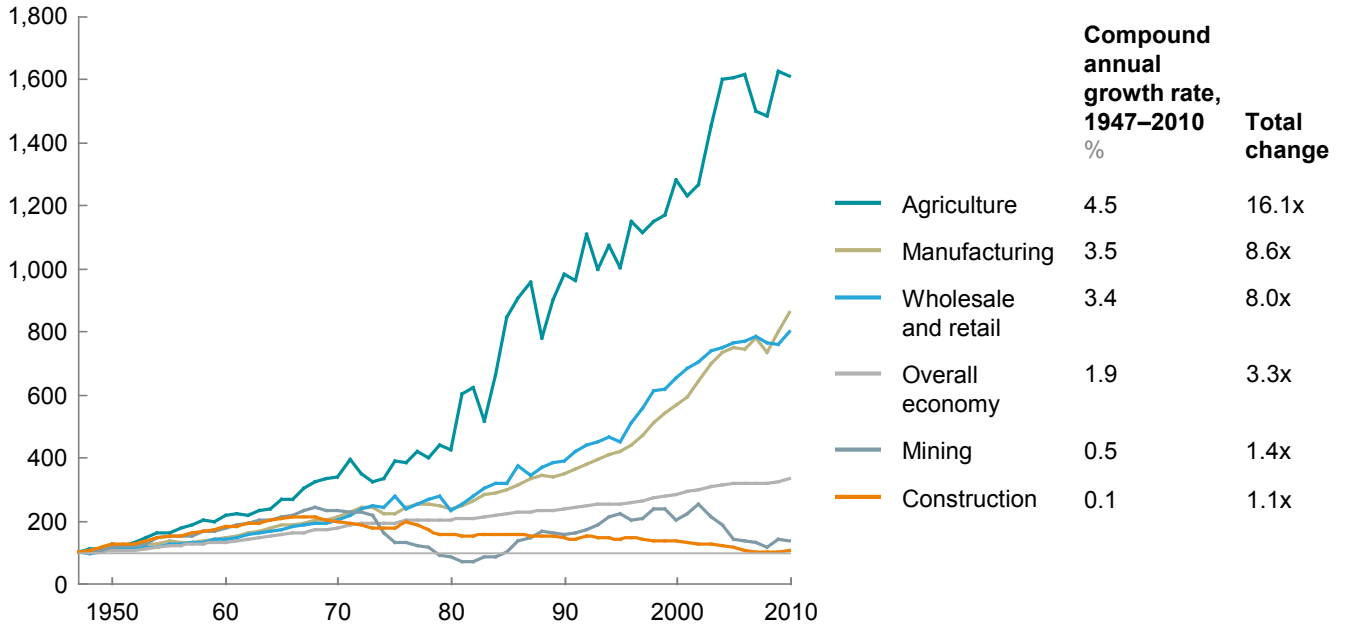

Many sectors have transformed and achieved quantum leaps in productivity; construction has changed little, limiting productivity gains

Key advances, 1947–2010

Agriculture	Manufacturing	Retail	Construction
Leveraged scale through land assembly and automation; deployed advanced bioengineering to increase yields	Implemented entirely new concepts of flow, modularized and standardized designs, and aggressively automated to increase production	Utilized scale advantages and cutting-edge logistics to provide affordable goods to the masses	Limited improvements in technological capabilities, production methods, and scale

SOURCE: World KLEMS; BLS; BEA; McKinsey Global Institute analysis

Over the past 20 years, the vast majority of countries have experienced lower labor-productivity growth in their construction sector than in their total economy (Exhibit 10). Only a few—Australia, Belgium, Egypt, Greece, Israel, and South Africa—have outperformed their economies in the long run. Many of those had specific construction booms or a weak overall economy.

Exhibit 10

Productivity has been slow compared with the total economy across geographies for the past 20 years

Differential in construction sector and overall economy labor productivity

Real gross value added per hour worked by persons engaged, compound annual growth rate, %

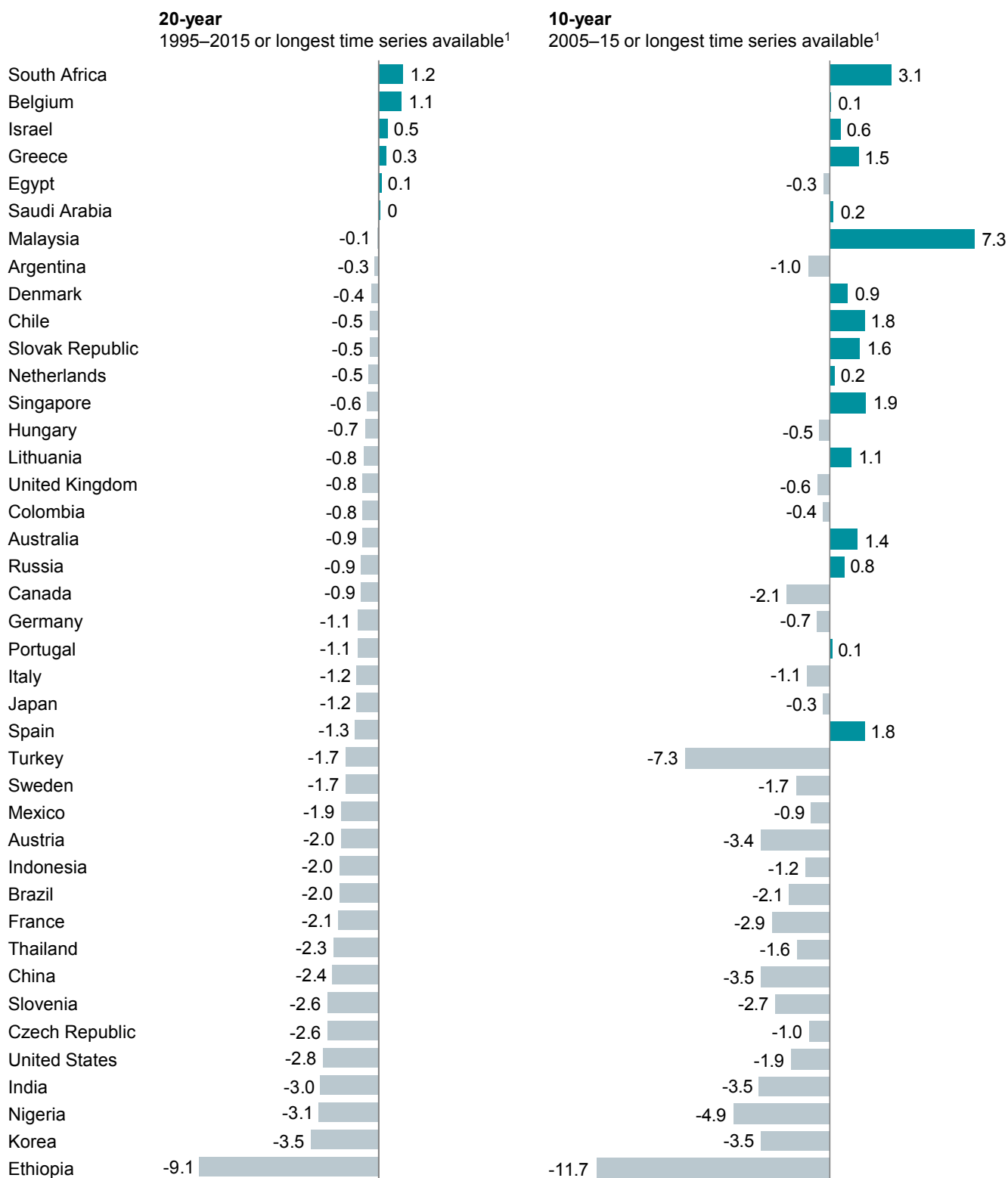

¹ Countries with a shorter time series due to data availability: Argentina, Australia, Brazil, Chile, Ethiopia, Japan, Mexico, Nigeria, South Africa (1995–2011); Belgium (1995–2014); China (1999–2014); Colombia (1995–2010); Czech Republic, France, Israel, Malaysia, Russia (1995–2014); Egypt (1995–2012); Indonesia (2000–14); Saudi Arabia (1999–2015); Singapore (2001–14); Thailand (2001–15); and Turkey (2005–15). Only persons employed data available; assumed each person worked 35 hours per week, 48 weeks per year.

SOURCE: OECD Stat; EU KLEMS; Asia KLEMS; World KLEMS; CDSI, Saudi Arabia; Ministry of Labor, Saudi Arabia; WIOD; GGDC-10, Oanda; McKinsey Global Institute analysis

The picture improves slightly when we look at the medium term. The construction sectors of Chile, the Iberian Peninsula, Malaysia, and some Eastern European economies including Lithuania, Russia, and the Slovak Republic have achieved rapid acceleration in labor-productivity growth compared with other sectors over the past decade. However, the fact remains that, even in the medium term, the construction sector continues to be a drag on overall productivity.

Many nations that are considered leaders in economic development and technological advancement have struggled to improve construction labor productivity in any meaningful way over the past 20 years. Most advanced economies with high absolute productivity levels have exhibited negative or stagnant productivity growth in their construction sectors during this period. Most notably, construction sector labor productivity in France, Japan, and the United States has declined over the past 20 years—in short, construction in these countries is less productive today than it was in 1995.²⁰ Other advanced economies have better records—Canada, Germany, and the United Kingdom have all registered labor-productivity improvements in their construction sectors. Even there, however, total economy labor-productivity growth has been stronger than in construction.

In emerging economies, there is similar variety, with some countries lagging in construction sector labor productivity and others achieving healthy rates of productivity growth in the sector. Nevertheless, with the exception of Egypt and South Africa, even in the latter group, construction sectors have not kept pace with their overall economies on productivity (Exhibit 11).

Our analysis has further found that labor productivity in the construction industry develops in a highly non-linear relationship with economic development. The labor productivity of a construction sector tends to remain very low (and fall) during the early stages of an economy's development, and then start rising substantially only when the economy reaches middle-income status, which we define as having annual per capita GDP of around \$10,000.²¹ It then tends to flatten out again.

We have clustered a selection of countries into four groups—two in emerging economies, two in developed economies—that share similar performance on construction sector labor productivity, and where laggards might learn from leaders. We identified key markets of particular interest and looked at them in more detail (see country case studies throughout this report—these are summaries of interesting findings based on input from experts rather than exhaustive profiles of the construction sectors in these economies).

²⁰ This does not mean productivity in building the exact same structure has declined. As we have noted, productivity statistics imperfectly incorporate quality improvements in construction over time.

²¹ The World Bank analyzes a range of middle-income countries whose per capita gross national income ranges from \$1,026 to \$12,476. It is at the upper end of this range where we start to see an acceleration of construction productivity growth. See “New country classifications by income level,” TheDATABlog, World Bank, January 7, 2016.

Exhibit 11

A small number of countries have achieved healthy productivity levels and growth rates

- Sector productivity growth lags behind total economy
- Sector productivity growth exceeds total economy

Size indicates total country construction investment, 2015 500 \$ billion

Construction labor productivity, 2015¹

2005 \$ per hour worked by persons employed, not adjusted for purchasing power parity²

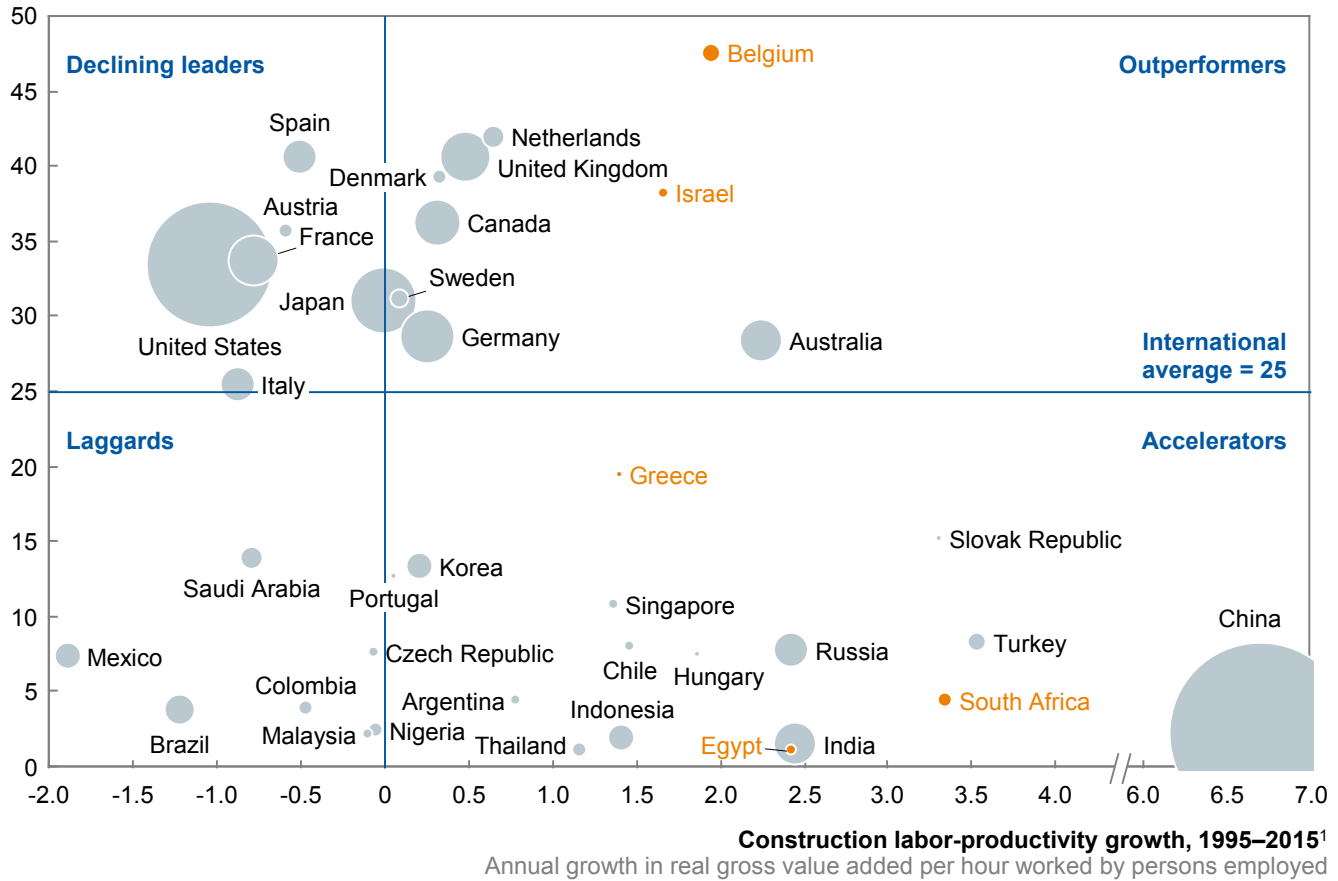

1 Countries with a shorter time series due to data availability: Argentina, Australia, Brazil, Chile, Ethiopia, Japan, Mexico, Nigeria, South Africa (1995–2011); Belgium (1999–2014); China, Colombia (1995–2010); Czech Republic, France, Israel, Malaysia, Russia (1995–2014); Egypt (1995–2012); Indonesia (2000–14); Saudi Arabia (1999–2015); Singapore (2001–14); Thailand (2001–15); and Turkey (2005–15).

2 Published PPPs are either not applicable (i.e., are not for the construction sector specifically or not for a value-added metric) or vary too widely in their conclusions to lend any additional confidence to the analysis.

SOURCE: OECD Stat; EU KLEMS; Asia KLEMS; World KLEMS; CDSI, Saudi Arabia; Ministry of Labor, Saudi Arabia; WIOD; GGDC-10; Oanda; IHS; ITF; GWI; McKinsey Global Institute analysis

Among emerging economies:

- **Laggards (low productivity, negative productivity growth).** The construction sectors of a few countries fall behind those in the rest of the world on both the level and growth rate of productivity. Some, such as Brazil, have suffered recently from government instability and economic downturn. Others, such as Saudi Arabia, have focused on increasing construction output by importing migrant workers rather than improving the productivity of existing workers. Laggards can particularly learn from accelerators on how to raise productivity.
- **Accelerators (low productivity, strong positive productivity growth).** As developing economies globalize, nascent construction sectors are rapidly expanding, producing large volumes of new buildings, infrastructure, and heavy industrial installations, and spurring rapid productivity gains in countries such as China, India, and Turkey. Because these gains rely on well-established practices in developed economies, they will fall short of closing the gap between construction and other sectors. However, these countries are positive models for implementing best practices with existing technology that others may find useful to emulate.

Among advanced economies:

- **Declining leaders (high productivity, negative productivity growth).** Many of the construction sectors of the world's leading economies fall into this category. While they enjoy high levels of productivity, it has been falling for two decades. In some countries, such as Spain, highly cyclical boom-bust periods have dampened sustained productivity growth. Cyclical hampers productivity in several ways. The associated hiring and firing of workers makes it difficult for firms to invest in training and for workers to continually improve their skills. Cyclical also makes it difficult to invest more in capital-intensive automation and digital solutions. In other countries where the decline has been smoother, as in the United States, a confluence of output mix and labor factors has contributed to the loss in construction sector productivity.
- **Outperformers (high productivity, positive productivity growth).** While scarce, a few countries have sustained growth even with high absolute productivity. Understanding the characteristics of the construction sectors in countries such as Australia, Belgium, the Netherlands, and the United Kingdom can inform global solutions.

CONSTRUCTION PRODUCTIVITY MATTERS FOR CONTRACTORS, OWNERS, AND ECONOMIES

Poor productivity in the construction industry matters for economies as a whole as well as for owners and contractors engaged in the sector.

Construction labor productivity matters for economies

The poor productivity performance of the construction sector is a missed opportunity to create value that we estimate at between \$1.6 trillion and \$2.3 trillion (Exhibit 12). We arrived at the \$1.6 trillion figure by benchmarking construction against overall productivity in the economies that we have examined. The \$2.3 trillion figure results from benchmarking construction against manufacturing (see Box 2, "Comparing manufacturing with construction"). While innovations in how manufactured goods are produced have propelled the sector to new productivity heights, construction has been unable to keep up.²²

²² To calculate the numerical gap, we assumed that productivity in the construction sector rises to either the level of the total economy's average productivity or the manufacturing sector's productivity level, respectively. Holding total construction output constant, the sector would be able to reduce the number of hours worked to achieve the same output because workers would be more productive. We estimated the value of lost output by examining what workers no longer needed in construction would be able to produce at the average total economy productivity level.

The amount of value lost—and therefore the size of the opportunity available from improved productivity in the construction sector—varies from region to region. The value lost is primarily in developed nations where the majority of construction output occurs. North America accounts for nearly one-third of the total potential lost value, or \$690 billion; together, all developed nations are responsible for 70 percent of the \$2.3 trillion productivity gap between the construction sector and the total economy.

Exhibit 12

Lagging construction productivity costs the global economy \$1.6 trillion a year

Total productivity differential, 2015
Real gross value added per hour, 2005 \$

Average productivity
■ Construction sector
■ Total economy

↓ Economic value lost as a result of productivity gap¹
(\$ trillion)

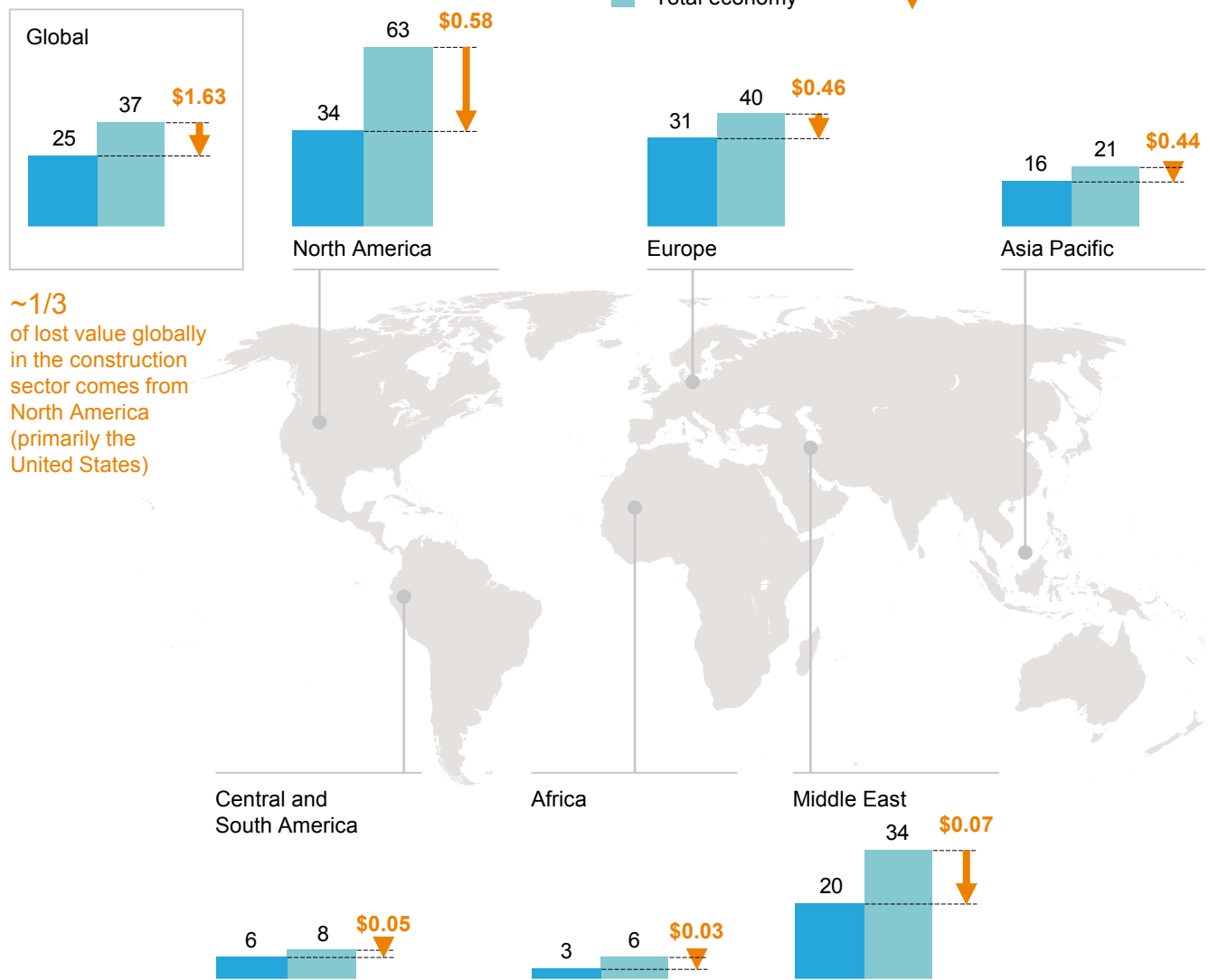

~1/3 of lost value globally in the construction sector comes from North America (primarily the United States)

¹ Assumes construction sector output remains constant and current workers are re-employed in other sectors at the total economy productivity rate.

SOURCE: OECD; WIOD; GGCD-10; World Bank; BEA; BLS; Turkish National Statistics Bureau; Singapore National Statistics Agency; Malaysian Statistics Agency; Rosstat; IHS; ITF; GWI; McKinsey Global Institute analysis

Box 2. Comparing manufacturing with construction

Manufacturing is a reasonable benchmark for our discussion of construction labor productivity for many reasons. In its most productive state, construction should be able to execute a lean philosophy, standardize its product offerings, and modularize its designs as manufacturing firms do. The same sources of waste that manufacturing has overcome—excess inventory, delays on-site, rework, and overprocessing, for instance—often still plague the construction sector.

However, we acknowledge that there are large differences between the construction and manufacturing sectors that make direct comparison difficult. For instance, construction is unable to capture scale benefits from consolidation in the same way that manufacturing does because the sheer size of the products produced means that construction is, to a degree, a local industry. In addition, the construction industry has a higher degree of labor intensity than the manufacturing sector. Among the key differences between the two sectors are:

- **Construction is not mobile:** Workers must come on-site, and companies cannot move sites to where labor is available.
- **Work spaces overlap:** Different types of trades (for example, pipe fitters and electricians) must work in the same area, making workflow planning more challenging.
- **Location of work site is dynamic:** Construction sites grow as they progress—for instance, a site may move many miles in the course of completing a highway.
- **Staging and setup are continuous:** Every construction project initially requires the creation of an entirely new workspace.
- **Larger number of uncontrolled variables:** Construction takes place in a range of climates and geographies, and sites are exposed to unpredictable conditions, including geological and topographical complexities and prevailing weather patterns. We have not attempted to quantify the impact of these factors. However, it is worth noting that, in terms of dollars per hour, the difference between the total economy benchmark and the manufacturing benchmark is approximately \$2, or less than 10 percent. One reason that there isn't a bigger gap between manufacturing and the total economy is that the significant heterogeneity in manufacturing—a sector that includes advanced auto manufacturing as well as basket weavers—averages out.
- **Bespoke requirements:** Today, structures are typically built to highly specific owner requirements, while mass customization is often sufficient in manufacturing. However, mass customization may well be feasible in construction, too, once it provides similar benefits of cost and quality.

Construction productivity matters for companies, workers, and owners

The economic value created from a productivity boost of \$1.6 trillion would be distributed among stakeholders as higher wages for workers, higher EBITDA margins for companies, and lower prices for owners. The split will be mostly determined by the competitive setup and labor-market characteristics.

At the firm level, our analysis of microdata suggests that higher productivity typically benefits firms in terms of EBITDA margins, although the correlation is not strong, as optimization of purchased input cost and revenue maximization can play an even more significant role for companies than productivity in the current market (Exhibit 13).

Productivity growth varies widely among companies; we see weaknesses, but also some strength. In our sample of companies, we found that productivity growth in about 25 percent of companies exceeded the productivity growth of the total economies in which they were based. While this is a small share of the corporate population, it does indicate that some players manage to outperform.

Exhibit 13

There is some correlation between productivity and profitability: Productivity matters for the individual firm

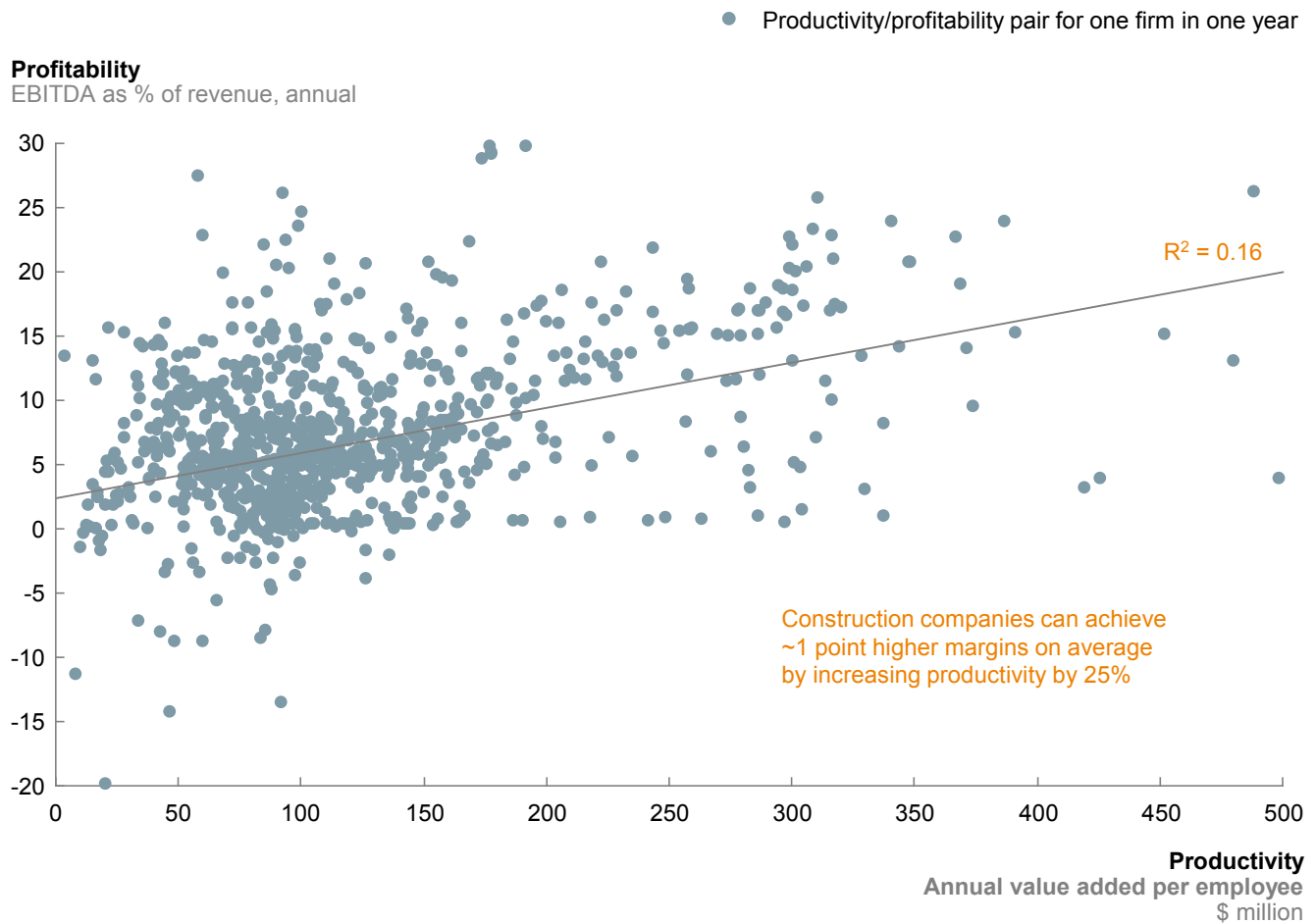

SOURCE: Bureau van Dijk; 100 largest construction companies by revenue with publicly available data for FY 2005–15; McKinsey Global Institute analysis

This finding at the company level is corroborated by project-level data. Data from the Construction Industry Institute on concrete pouring and cable laying shows declining productivity since 1996, although we note that even within a small sample size there were large spreads in productivity levels each year among individual projects.

From the owners' perspective, cost and time matter most; and, again, the performance of construction is relatively poor.

We also continue to observe enormous cost and time overruns of construction projects, with our recent analysis finding average cost and time overruns relative to original budget and schedule at 70 percent and 61 percent, respectively.

In addition, in all markets that we looked at, the average price of construction projects had risen faster than the consumer price index between 2008 and 2016. This illustrates the relative decrease in value that is delivered by the construction industry with respect to the rest of the economy (Exhibit 14).

Exhibit 14

Costs of construction projects have in general outpaced the growth in consumer price index

Project costs (local currency) vs. consumer price index

% change in average project cost per sq. ft., 2008–16

■ Average project costs rising slower than CPI

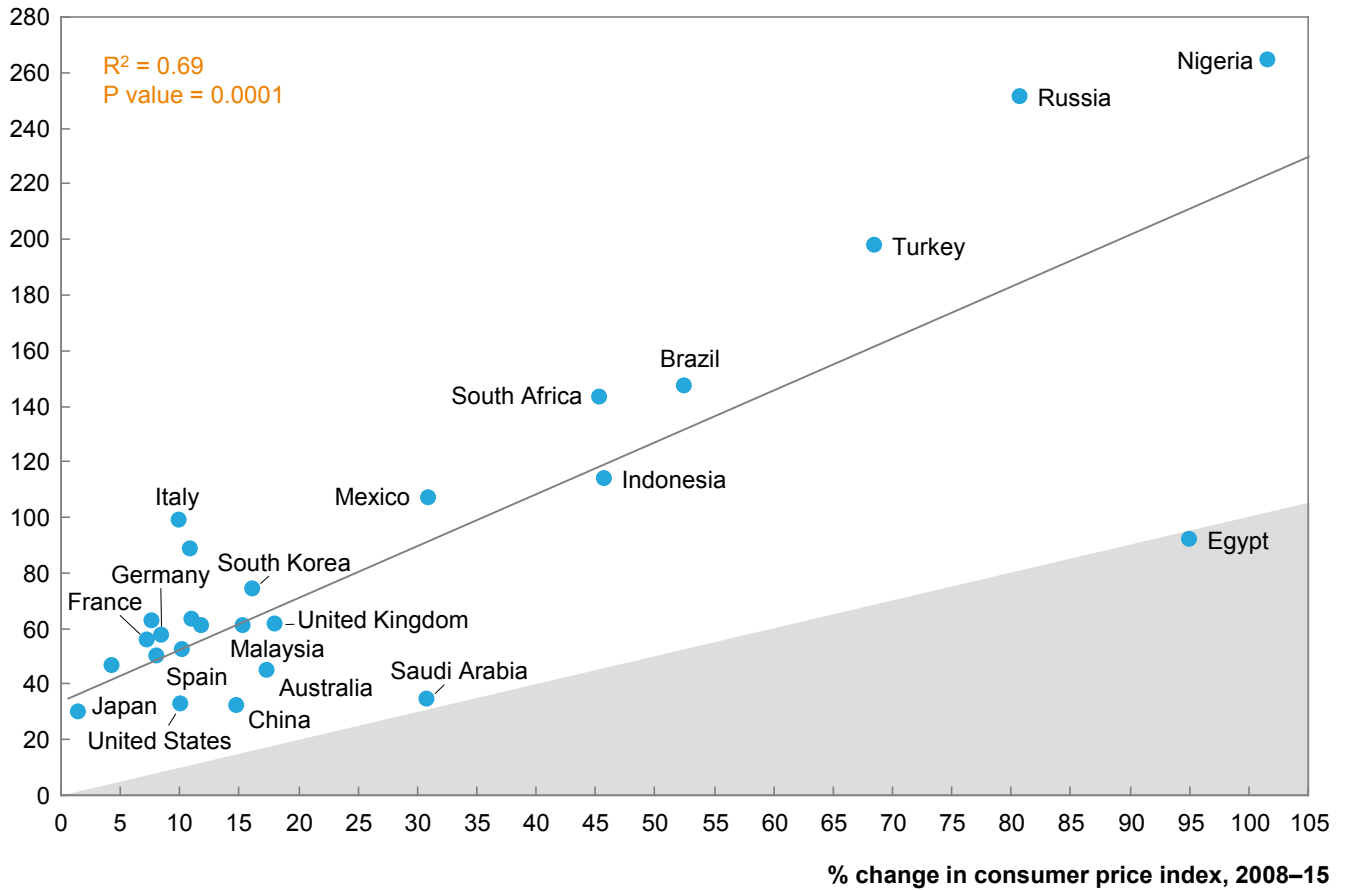

SOURCE: Compass International; McKinsey Global Institute analysis



The poor labor productivity of the construction industry is pervasive. It is a long-term issue that affects virtually every economy whatever its stage of development, and it has not been tackled for decades. The cost to the industry is substantial—but therefore so is the opportunity. Why, then, has the construction industry failed to face up to its productivity problem? The answer is a range of root causes, which we discuss in Chapter 2.



CASE STUDY: UNITED STATES

Productivity and demand trends. Productivity in the US construction industry more than doubled in the 20 years following the end of World War II, reflecting productivity increases in the overall economy, huge investment in the interstate highway system, and housing in new suburbs, for instance. After this, however, the sector’s productivity appeared to decline for 40 years as the focus shifted from infrastructure projects toward more residential building, and repair and renovation work, which involves more complex sites (see Exhibit 9 on page 23). This shift in the mix makes it hard to draw direct historical comparisons of productivity levels. Moreover, ongoing revisions by the Bureau of Labor Statistics of productivity measurements have indicated substantial positive growth in subsectors for which the bureau used new output deflators.

Government interventions and regulatory setup. In 2006, the General Services Administration mandated that new construction designed through its Public Buildings Service use BIM and open-standard facility management data for all project milestones. The agency specifically encourages deployment of mature 3D, 4D, and 5D BIM technologies. The cost savings on one pilot project using these technologies paid for the cost of another nine pilots in the first year. Outside public building construction, the government has not addressed construction productivity directly through regulation although the industry is highly regulated, and building codes are local.

Technology investments. Uptake of new technology is lower than in other US sectors; only agriculture is less digitized. However, new software solutions (including BIM, productivity apps, augmented reality design, radio frequency identification, sensors for material management, and so on), drones, and virtual reality devices are becoming somewhat more popular among contractors. In an August 2016 survey by the Associated General Contractors of America, 21 percent of respondents said that they were investing in labor-saving equipment, 13 percent in off-site prefabrication, and 7 percent in BIM. Forty-eight percent of respondents said that they had raised base pay and invested in in-house training to cope with worker shortages. According to another survey the following November, 73 percent of contractors said they planned to raise head count to prepare for strong expected public- and private-sector demand in 2017; there is concern that there will be a shortage of qualified labor to meet this demand. There are limited incentives to make large investments in labor-saving innovative technologies and processes such as prefabrication because most companies are too small to enjoy economies of scale. Moreover, using technology on a large enough scale for the investment to pay off would require the approval of multiple government authorities because the United States does not have nationwide building standards.¹

Productivity evolution, 1995–2015
Gross value added¹ per hour worked
Index: 100 = 1995

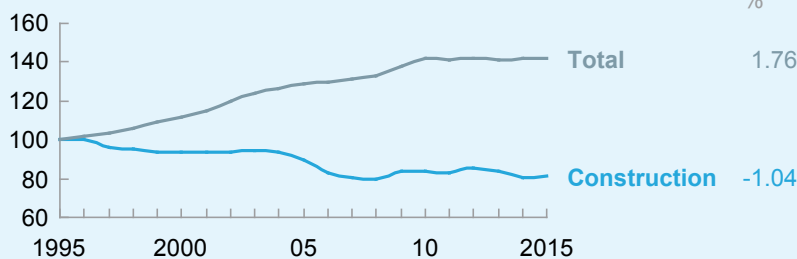

Compound annual growth rate
%

Total: 1.76
Construction: -1.04

Sector size and composition
2015 \$ billion

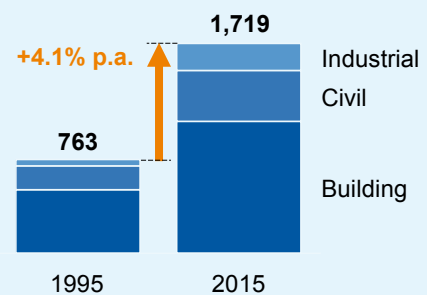

\$33 per hour
2015 construction productivity level

\$67 per hour
2015 average economy productivity level

\$527.5 billion
Annual value¹ lost to low productivity

¹ 2005 USD, non-PPP adjusted

SOURCE: BEA; BLS; OECD; World KLEMS; IHS; ITF; GWI; World Energy Outlook; Moody’s Analytics; US national accounts; McKinsey Global Institute analysis

¹ US construction trends and outlook, Q3, JLL, 2016; General Services Administration; Associated General Contractors of America survey, August 2016; Leo Sveikauskas et al., “Productivity growth in construction,” *Journal of Construction Engineering and Management*, volume 142, issue 10, October 2016; Peggy Yee et al., *The GSA BIM story*, May-June 2011; C. T. Koebel, “Innovation in home building and the future of housing,” *Journal of the American Planning Association*, volume 74, number 1, 2008.



CASE STUDY: BELGIUM

Productivity and demand trends. Construction productivity in Belgium has grown steadily in recent years. Urbanization and household growth are not fueling demand in Belgium as they are in other countries, and the share of (lower-productivity) renovations is higher than new construction. However, wages in the construction sector are comparatively high, incentivizing the adoption of technology and thereby driving productivity. Belgium's labor costs are on average 4 percent higher than those in France, Germany, and the Netherlands, but its unit labor costs are 15 percent lower due to higher productivity. Belgian companies are known for their expertise in highly productive maritime engineering construction and dredging work, and between 2010 and 2014 there was a boom in the construction of offshore wind farms, which take advantage of innovative prefabricated concrete-pillar technology. Land-based wind farm construction has also steadily increased since the mid-2000s.

Government interventions and regulatory setup. Belgian construction regulations are based on the EU's common design codes, which emphasize quality and sustainability. The energy performance of buildings has been a focus since the late 2000s. However, each of Belgium's three regions has the authority to determine additional policies. The Flemish government, for example, offers a bonus of

€400 if at least ten neighbors (or households in the same town) undertake energy-saving renovations, such as installing insulation; this creates scale and reduces cost while meeting the goal of environmentally friendly building. Belgian regulations do not actively target construction productivity, but they are relatively non-restrictive, allowing for innovation. Some public institutions such as the Center for Road Research promote technological innovation in specific areas of construction.

Technology investments. In part encouraged by high labor costs, the construction industry has invested in labor-saving processes. Mechanization is being maximized. Off-site prefabrication is widely used, especially by larger companies. Belgium is a global leader in architectural concrete, including walls, balconies, and outdoor furniture, exporting 30 to 40 percent of its national production. One-third of all concrete used in Belgium is prefabricated (and is used in wind turbines, for instance), and concrete makes up to 90 percent of the entire volume of the industry. Private entities such as the Belgian Building Research Institute and the Belgian Construction Confederation have introduced voluntary sustainable and quality construction certification systems that have encouraged R&D investment and innovation, and they hold competitions with prizes for innovation.¹

Productivity evolution, 1999–2014
Gross value added¹ per hour worked
Index: 100 = 1999

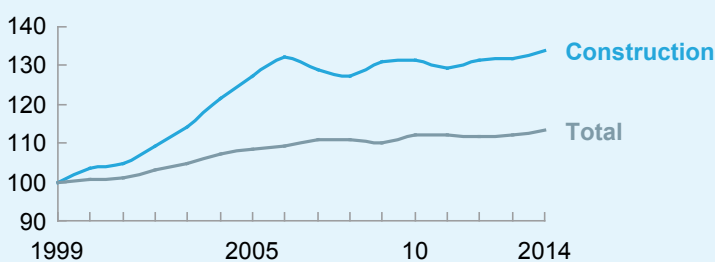

Compound annual growth rate
%

Construction: 1.96
Total: 0.83

Sector size and composition
2015 \$ billion

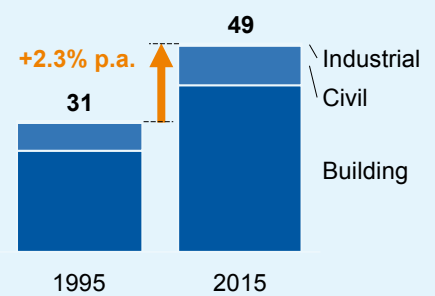

\$48 per hour

2014 construction productivity level

\$57 per hour

2014 average economy productivity level

\$5.2 billion

Annual value lost¹ to low productivity

¹ 2005 USD, non-PPP adjusted

SOURCE: WIOD; OECD; World KLEMS; IHS; ITF; GWI; World Energy Outlook; Belgium national accounts; McKinsey Global Institute analysis

¹ *Investir dans la construction (Investing in construction), Annual Report 2011–12, Confédération Construction, 2012; Arbeidskosten, loonsubsidies, arbeidsproductiviteit, en opleidingsinspanningen van de ondernemingen (Labor costs, wage subsidies, labor productivity, and training efforts by enterprises), Statistics Belgium Expert Group on Competitiveness and Employment, July 2013; Association pour la Promotion des Énergies Renouvelables (Association for the Promotion of Renewable Energies).*



Construction workers using digital tablet at construction site
© Simonkr/Getty Images

2. MARKET FAILURES AND INDUSTRY DYNAMICS

Fixing the productivity issues in the construction industry is challenging, and the first step is to fully understand the external forces and market failures as well as industry dynamics that lie at the root of the productivity problem. We have examined ten major root causes of low productivity and market failures in the sector, many of which have been discussed within the industry for some time but have not yet triggered concerted action to address them.

A TALE OF TWO INDUSTRIES: CONSTRUCTION HAS TWO DISTINCT PARTS

To fully understand the root of the productivity problem, we need to move beyond the construction sector as a whole and examine its constituent parts—asset classes and firms. The construction sector is not uniformly performing poorly on productivity. To ascertain where the major problems lie, we looked at construction subsectors (see Box 3, “How is the construction sector classified into subsectors?”).

The construction sector is not homogenous. Indeed, it virtually splits in half between large-scale players engaged in heavy construction such as civil and industrial work and large-scale housing, and a large number of fragmented specialized trades such as mechanical, electrical, and plumbing that act as subcontractors or work on small projects such as single-family housing.

Box 3. How is the construction sector classified into subsectors?

Economists classify construction companies into subsectors on the basis of their specialization. At the broadest level, there are two groups:

- **Diversified companies** engage in multiple types of projects requiring the performance of different construction activities.
- **Trade-based or specialty companies** are engaged in a single trade (for instance, plumbing or painting) that they use for many projects.

The diversified companies are further classified as producers of building, civil, or industrial assets according to the sources of a majority of their business. Together, this classification program creates four distinct subsectors of construction:

- **Building construction:** Construction of residential and non-residential structures, including commercial and social buildings.
- **Civil construction:** Construction of all types of civil works, including transportation, utilities, and telecommunications.
- **Industrial construction:** Construction of light and heavy industrial facilities, including warehouses, manufacturing, oil and gas installations, and mining installations.
- **Specialty construction:** Specialized trade construction of elements common across all types of construction (for instance, framing, roofing, glass and glazing, masonry, drywall, and insulation).

The two main groups have very different productivity (Exhibit 15). The poor productivity of the construction sector largely reflects small firms carrying out specialized, trade-based work; in Exhibit 16, they overwhelmingly appear in the lower left quadrant. Specialty contractors in aggregate create more than 50 percent of the sector's value added—more than building, civil, and industrial construction combined—but they have the lowest productivity of any subsector (Exhibit 16).

Exhibit 15

Smaller trades trail on productivity levels and growth

NOT EXHAUSTIVE

US example

- Specialty
- Civil
- Building
- Industrial

Size indicates economic value added, 2012
2015 \$ million



— US construction average

Productivity, 2012

\$ thousand per person employed, 2015 \$

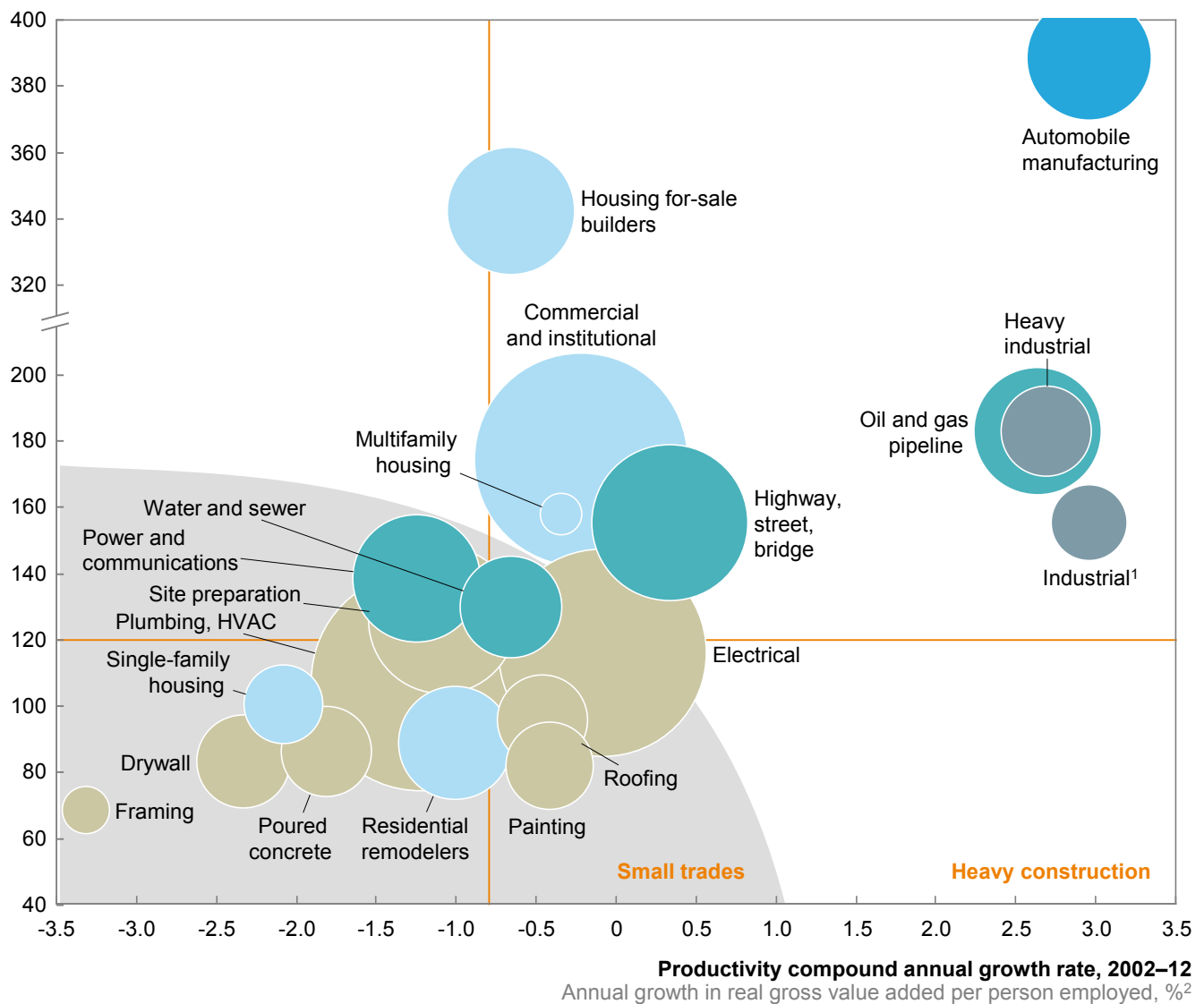

1 Manufacturing plants and warehouses.
2 All subsectors deflated with overall construction sector deflators, not subsector-specific prices.

SOURCE: US Economic Census; McKinsey Global Institute analysis

Exhibit 16

Specialized contractors across asset classes are the largest type of construction player—and have the lowest productivity

Construction productivity by subsector

Value added per employee, indexed total sector = 100, 2013

High and low outliers of countries in data set¹

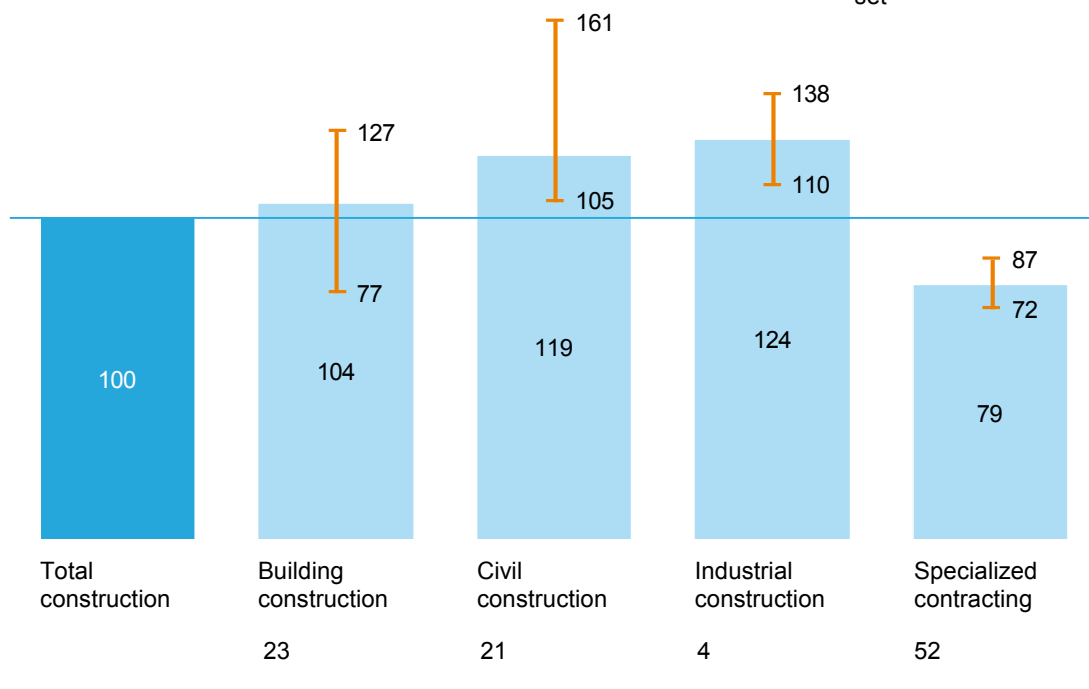

¹ United States, Canada, Australia, EU-15 (Austria, Belgium, Denmark, Finland, France, Germany, Greece, Ireland, Italy, Luxembourg, the Netherlands, Portugal, Spain, Sweden, United Kingdom).

SOURCE: US Census Bureau; Eurostat; Statistics Canada; Australia Statistics Bureau; McKinsey Global Institute analysis

In the first group, builders of industrial infrastructure have, on average, the highest productivity at 124 percent of the industry as a whole, followed by civil-construction players at 119 percent and large-scale building constructors at 104 percent. Trades contractors and subcontractors, which are responsible for a large share of value in small real estate and refurbishment projects, are typically relatively small and have about 20 percent lower productivity than the sector average. Any solution needs to look at the entire supply chain and both parts of the market.

Specialized construction underperforms on labor productivity in both level and growth terms. In the United States, for example, the labor productivity of segments of specialty construction such as plumbing, the installation of heating, ventilation, and air-conditioning, and electrical has stagnated or declined.

It is striking that the entire \$1.6 trillion productivity gap we discussed in Chapter 1 is due to the low level of productivity among specialty contractors. It is important to note that this does not mean civil and industrial construction delivers overwhelmingly strong performance on productivity—companies engaged in these asset classes suffer from their own problems. And specialized trades are heavily involved in those categories, typically acting as subcontractors for larger building, industrial, and—to a lesser extent—civil-construction firms. In buildings, for instance, 48 percent of construction value added is generated by specialized trades. The disparities on productivity performance underline the importance of the output mix on a construction sector’s productivity.

In general, small firms are less productive than large firms. In the United States, for example, firms with less than \$1 million in annual revenue are half as productive as those with revenue over \$10 million. Looking at firms of all sizes in US construction, companies with annual revenue of less than \$50,000 accounted for only \$6 of value added per hour worked in 2012, while those with annual revenue of between \$5 million and \$10 million added \$77. In Europe, home to some of the largest construction firms in the world, the average construction productivity of countries is well below that of the biggest construction firms in those countries. This indicates that in this region, too, smaller firms are dragging down the productivity of the sector as a whole (Exhibit 17).

Exhibit 17

The largest engineering and construction firms around the world are more productive than their host economies—illustrating the benefits of scale

Comparison of national construction productivity level to productivity level of largest construction firms

Value added per employee, average 2010–14
\$ thousand

Country construction average

Largest companies

Number of companies

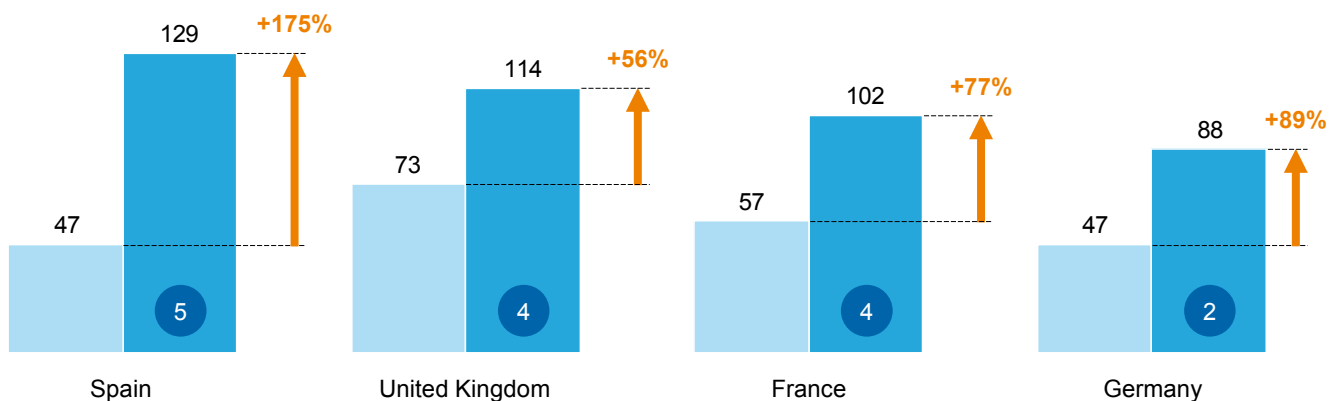

NOTE: "Large companies" considers only firms headquartered in a country with annual revenue in excess of \$5 billion. Numbers may not sum due to rounding.

SOURCE: Bureau van Dijk; Eurostat; McKinsey Global Institute analysis

One of the reasons small construction companies are not able to match the productivity of large ones is that they are unable to gain the advantage of scale benefits. The lack of scale among specialty firms means that they have limited repeatability, high shares of manual and repair work, and constrained job sites. One example of an activity that is unconstrained and has high repeatability is preparing a site. There are no existing structures impeding progress, and tasks including earth moving, grading, and forming are repeatable—as are the erection of structural steel and the pouring of pre-cast concrete. These activities are about 50 percent more productive than activities such as framing or masonry that are often custom-built, are conducted on a smaller scale, and require more manual labor. The average real value added per employee between 2002 and 2012 (in 2015 dollars) was \$130,000 a year for site preparation and \$120,000 for structural steel and pre-cast concrete, but only \$83,000 for masonry and \$79,000 a year for framing. Specialty contractors also face challenging timing elements. They often come in at the end of a job when space is constrained and the ability to fix mistakes is limited. Only 17 percent of the subsector completes work at the beginning of a job.

Another reason for the low productivity of specialized trade subcontractors is their position in the value chain. The largest and most productive firms typically focus on the highest-value activities, while outsourcing lower-value tasks to suppliers. Yet another one is that they have fewer resources available to deploy sophisticated techniques and tools.

INTERLINKED MARKET FAILURES AND BROKEN INDUSTRY DYNAMICS ARE HOLDING BACK THE PRODUCTIVITY OF THE SECTOR

The issues holding back productivity in construction have been broadly understood for decades, but the competitive dynamics that should typically work to address those problems don't seem to be as prominent in construction as in other sectors. At the root of the sector's issue is the fact that this industry is so opaque, fragmented, and fraught with misaligned incentives that it is often not the most productive players that thrive.

External factors cause unfavorable industry dynamics, which in turn cause firm-level operational issues. At the macro level, projects and sites are becoming increasingly complex and brownfield; the construction industry is extensively regulated and highly dependent on public-sector demand; and informality and sometimes outright corruption distort the market. Compounding these issues are industry dynamics that contribute to low productivity: construction is among the most fragmented and least transparent industries in the world; the contracting structures governing projects are rife with mismatched risks and rewards; and often inexperienced owners and buyers are faced with navigating a challenging and opaque marketplace. The results are operational failures within firms, including inefficient design, insufficient time spent on implementing the latest thinking on project management and execution, a low-skilled workforce, and underinvestment in the technology and digitization that would help raise productivity.

Each of the two halves of the industry has experienced its own types of market failure, but the result in both cases is that market forces partly break down. Within heavy construction, increasingly complex projects and heavy regulation have combined with suboptimal procurement practices by owners to create unaligned contractual and incentive structures (Exhibit 18).

Exhibit 18

Market failures and external factors compromise how the industry functions and result in low productivity of firms of all sizes

	Light and specialized construction	Heavy construction
Players	<ul style="list-style-type: none"> Small and medium players in highly fragmented market Typically specialized contractors (e.g., roofing) 	<ul style="list-style-type: none"> Medium and large players Regional and global engineering and construction firms
Projects	<ul style="list-style-type: none"> Small real estate and refurbishment projects 	<ul style="list-style-type: none"> Large real estate, civil, and industrial projects
Key market failure	<ul style="list-style-type: none"> Opaque and highly fragmented market due to combination of <ul style="list-style-type: none"> Geographically dispersed projects, heterogeneous zoning and building codes, use of informal labor Inexperienced yet risk-averse owners on the buyer side 	<ul style="list-style-type: none"> Unaligned contractual and incentive structures characterized by hostility and change orders due to <ul style="list-style-type: none"> Increasingly complex projects, heavy regulation, in some regions corruption Suboptimal procurement centered on reducing initial price and offloading risk

SOURCE: McKinsey Global Institute analysis

The story is quite different for the smaller, light, specialized half of the construction market. There we observe geographically dispersed projects, heterogeneous zoning and building codes, small land plots, significant levels of informality in some geographies, and often inexperienced owners on the buyer side. All of these create an opaque and highly fragmented market. Owners do not have a transparent view on the cost of projects, and the productivity of trade contractors is hindered by their lack of scale.

Our discussion of the heavy construction part of the industry was informed by the findings of a survey conducted for this report (see Box 4, “The MGI Construction Productivity Survey”).

The top two root causes cited by survey respondents, who were largely active in the heavy construction part of the sector, were inefficient design processes and misaligned contractual structures (Exhibit 19). This comes as little surprise given that the design of a project and the contract that acts as its framework are the foundations of any construction process, occurring at the start, and therefore setting the tone for the entire venture. These two aspects also have an impact on multiple players.

It is indicative of the broken dynamics of the construction industry that owners, contractors, and suppliers do not agree on the perceived importance of particular root causes. Contractors and suppliers tended to identify contractual and incentive misalignments as the most significant market failures, but these scored five out of ten for owners. This presumably reflects the reality that the risk is largely allocated to contractors in current contractual models (see the discussion on contracts later in this chapter and in Chapter 3 for more detail). In contrast, the survey results revealed that the most important root causes cited by owners were project management and the basics of execution, the latter being ascribed by respondents to poorly qualified on-site staff. Interestingly, the survey showed that there are different opinions within the industry on the degree to which it is underinvesting in technology. For suppliers, this was the second most important root cause; for owners and contractors, it ranked only seventh out of the ten, which appears to indicate that suppliers feel the burden of investment in new technology without the support of the owners and contractors in the value chain.

Of course, the heavy construction half of the industry relies greatly on the other half of the sector and should have an incentive to help those smaller specialized trade contractors improve their productivity. The manufacturing sector provides an interesting parallel. Not long ago, trying to get ahead by squeezing suppliers on cost was a common strategy in manufacturing. However, manufacturing companies then realized that the better option was to manage supplier relationships as long-term partnerships to drive higher innovation, productivity, and collaboration.

Box 4. The MGI Construction Productivity Survey

The MGI Construction Productivity Survey was sent out in August and September 2016 to construction-industry CEOs representing asset owners, engineering and construction firms, suppliers, other institutions such as construction consulting firms, academics, and industry associations such as the Construction Industry Institute. Participants were asked to rank the relative importance of root causes of low productivity and indicate what their companies were doing to address them. Responses were received from companies active in all regions of the world.

The survey asked respondents for their view of the degree to which their company implements best practices across a range of solutions and for information on their company’s adoption of technology. Respondents were

also asked whether they plan to adopt a new technology within the next three years (if they had not already done so) and what they saw as the largest barriers to adoption of new technology. Participants were not selected randomly. MGI distributed the list to our network of industry contacts as well as through professional conferences in which we participated. We received 210 responses to the surveys on root causes and further responses on deeper insights on the use of best practice in the industry; we ranked the importance of the ten root causes while we tabulated answers on the other questions exclusively from completed surveys. We then tested our findings against our Global Productivity Database to measure their impact. See the technical appendix for more detail on the survey.

Exhibit 19

The relative importance for improving productivity of the ten root causes varies by industry player, but consistent themes emerge for all

Number of respondents = 210

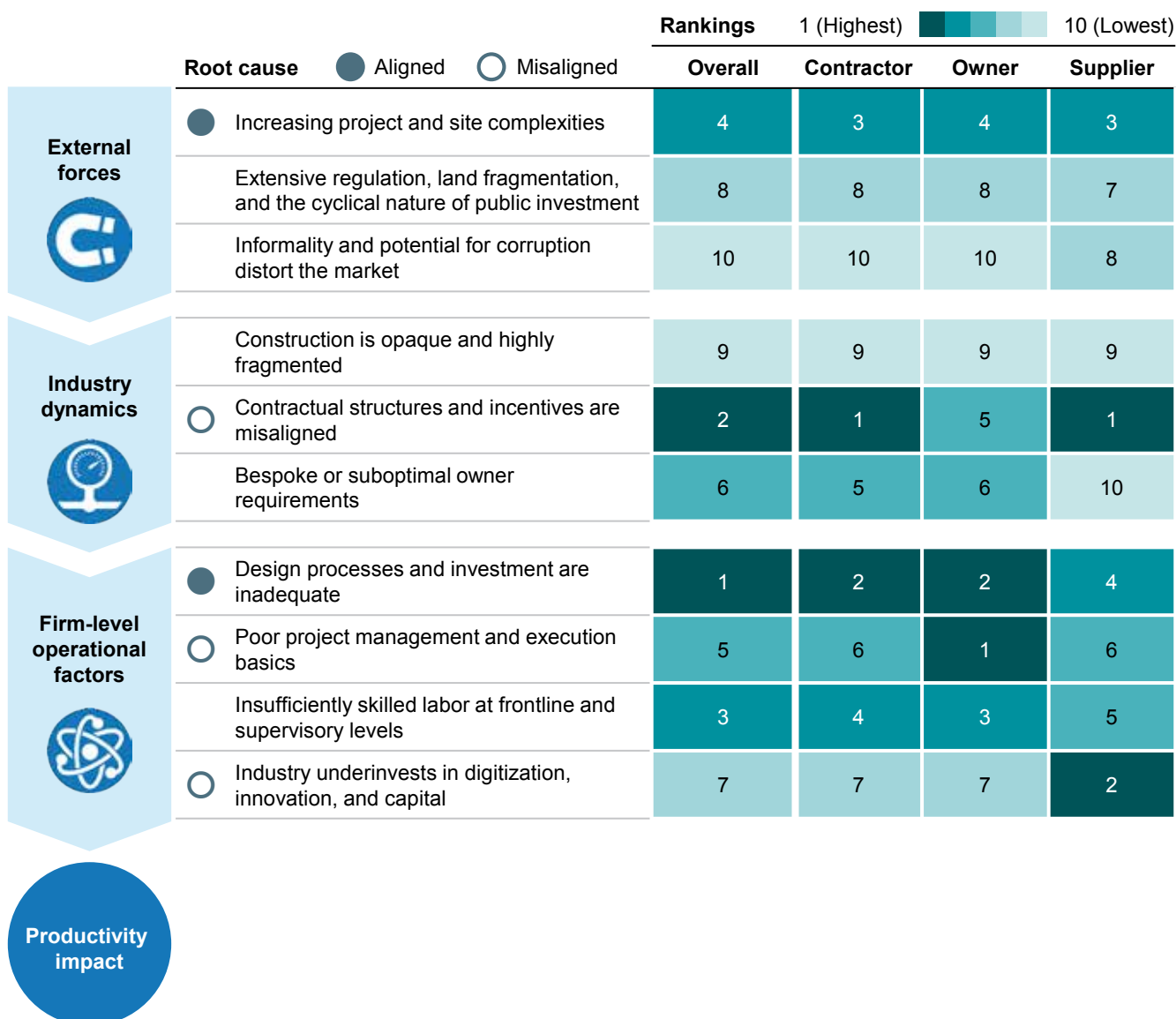

SOURCE: McKinsey Global Institute analysis

In the rest of this chapter, we discuss the ten root causes in three categories: three relate to the external environment, three to the industry’s dynamics, and the remaining four to operational factors within construction firms. There is a notable cadence to these root causes. Together, the three external forces are creating a dysfunctional industry that is highly fragmented and opaque. This, in turn, reinforces poor performance. The structural elements of this industry inhibit firms at an operational level, making it difficult for them to execute on elements that would make them more productive.

EXTERNAL FORCES: THE THREE ROOT CAUSES AT THE MACRO LEVEL ARE TYPICALLY THE MOST CHALLENGING TO ADDRESS

Macro-level root causes are typically the most challenging to tackle. For instance, the increasing size and complexity of projects is a customer need that will not just go away. But other areas such as fragmented regulation and informality can be addressed.

Root cause 1: Increasing project and site complexities

Growing demand for construction and the increasing density of existing development have combined to drive up the size and complexity of projects, both of which affect productivity. Complexity rises as projects increase in size, and this drags down productivity. Project outcomes also suffer. Projects included in the Construction Industry Institute's benchmarking database with "low" complexity have, on average, minus 4.2 percent cost slippage; projects with "medium" complexity have minus 0.2 percent slippage; and those with "high" complexity have 1.7 percent slippage. Megaprojects, defined as those valued at more than \$1 billion, are particularly susceptible to coordination challenges that can drag down productivity.²³ One study looked at the impact of an increasing number of work hours on a project and found that projects with one million work hours were 15 to 20 percent less productive on-site than those with only 100,000 work hours.²⁴ This is pertinent given that the volume of construction of megaprojects has quadrupled over the past decade (Exhibit 20). Increased complexity is also seen in smaller projects. According to the MGI Construction Productivity Survey, respondents working on projects with an average value of more than \$100 million were twice as likely as those with projects valued at less than \$5 million to name complexities as a top cause of low productivity.

Exhibit 20

Complex megaprojects account for an increasing share of global construction and are particularly vulnerable to cost and schedule overruns

Megaprojects as a share of global construction spending¹
%; \$ trillion

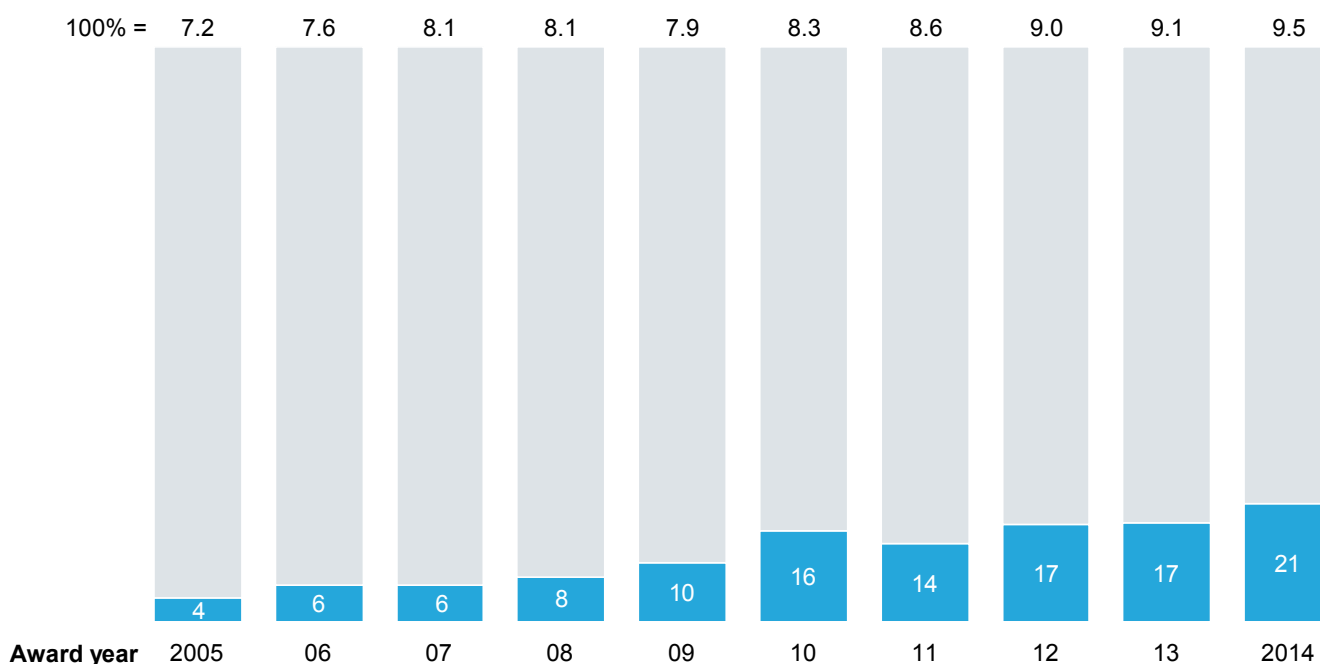

¹ Total project value >= \$1 billion; includes parent and standalone projects only, excludes subprojects.

SOURCE: IPAT; CIC; IJ Global; MEED; Zawya; India Infra Monitor; Dodge; SNL Mining; CGLA; Exame; IHS; ITF; GWI; McKinsey Global Institute analysis

²³ The Construction Industry Institute, based at the University of Texas at Austin, is a nonprofit consortium of more than 100 owners, engineering contractors, and suppliers in the public and private arenas. In addition to primary research, the institute maintains an extensive database to benchmark project performance, the Performance Assessment System (PAS). The PAS contains project performance and productivity data from more than 2,000 projects worth more than \$280 billion in all regions, asset classes, and size classes from less than \$5 million to greater than \$500 million. Greenfield and brownfield projects are also included. We either took data directly from the online PAS interface or took analysis conducted by Construction Industry Institute researchers. Where possible, we present statistically significant conclusions at a p = 0.10 confidence level.

²⁴ John W. Hackney and Kenneth King Humphreys, *Control and management of capital projects*, McGraw-Hill, 1991.

Construction in emerging economies is the main reason for the increase in megaprojects, as these economies require more advanced infrastructure investment. But the construction industry in developed economies is struggling with a different type of complexity. Many developed economies undertook major infrastructure investment decades ago, and they now need to focus on maintaining and upgrading those systems. US productivity data show that, as the proportion of repair and maintenance construction has increased, there has been a corresponding fall in productivity (Exhibit 21).

Exhibit 21

There is a strong relationship between productivity and the ratio of repair and maintenance to new construction

Proportion of type of construction in the US construction sector and associated productivity



SOURCE: US Economic Census; McKinsey Global Institute analysis

Repair and renovation work takes place in a constrained environment. Construction companies are forced to work on tight, often occupied sites where it is difficult to anticipate what complications they may uncover, and where it is hard to work at scale and with a high degree of standardization. Real estate projects in dense urban environments have constraints on standard working hours because of the need to avoid noise nuisance. Small lot sizes do not allow projects to be staged effectively, and transporting materials to the site presents challenges. For civil works, repairing roads or utilities requires stopping normal traffic and the use of major traffic systems, and is therefore carefully controlled.

Mass greenfield construction has largely ended in developed markets, giving way to refurbishment work (Exhibit 22). But brownfield sites are more complex to deal with, dampening productivity. Analysis by type of project finds that on three of the four productivity measures collected, brownfield projects lagged behind greenfield or simple expansion projects that benefit from replicable designs and well-established plans (Exhibit 23).

Exhibit 22

In developed economies, the share of renovations has increased from 35 to 60 percent, increasing operational constraints

Real capital expenditure, renovation vs. new construction

Renovation New construction

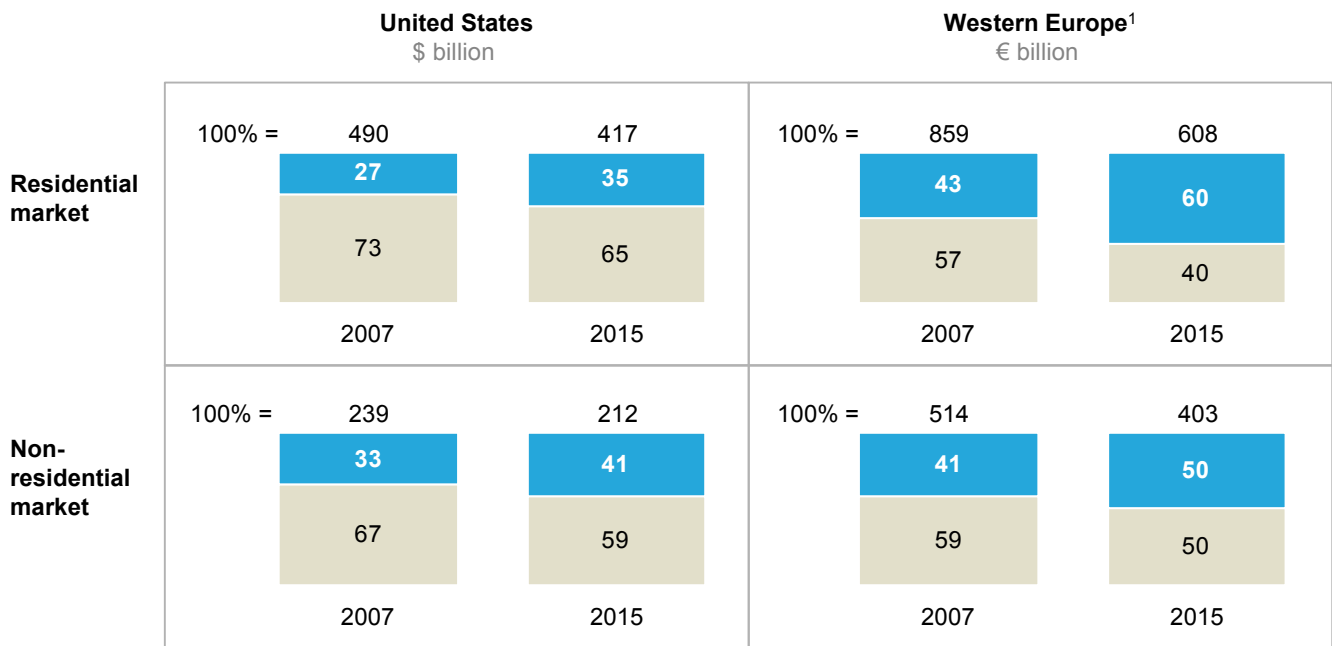

NOTE: Numbers may not sum due to rounding.

SOURCE: IHS; McGraw Hill Construction; Euroconstruct; McKinsey Global Institute analysis

Exhibit 23

Greenfield projects have higher productivity than brownfield, indicating the benefits of less constrained sites with lower levels of uncertainty

Productivity

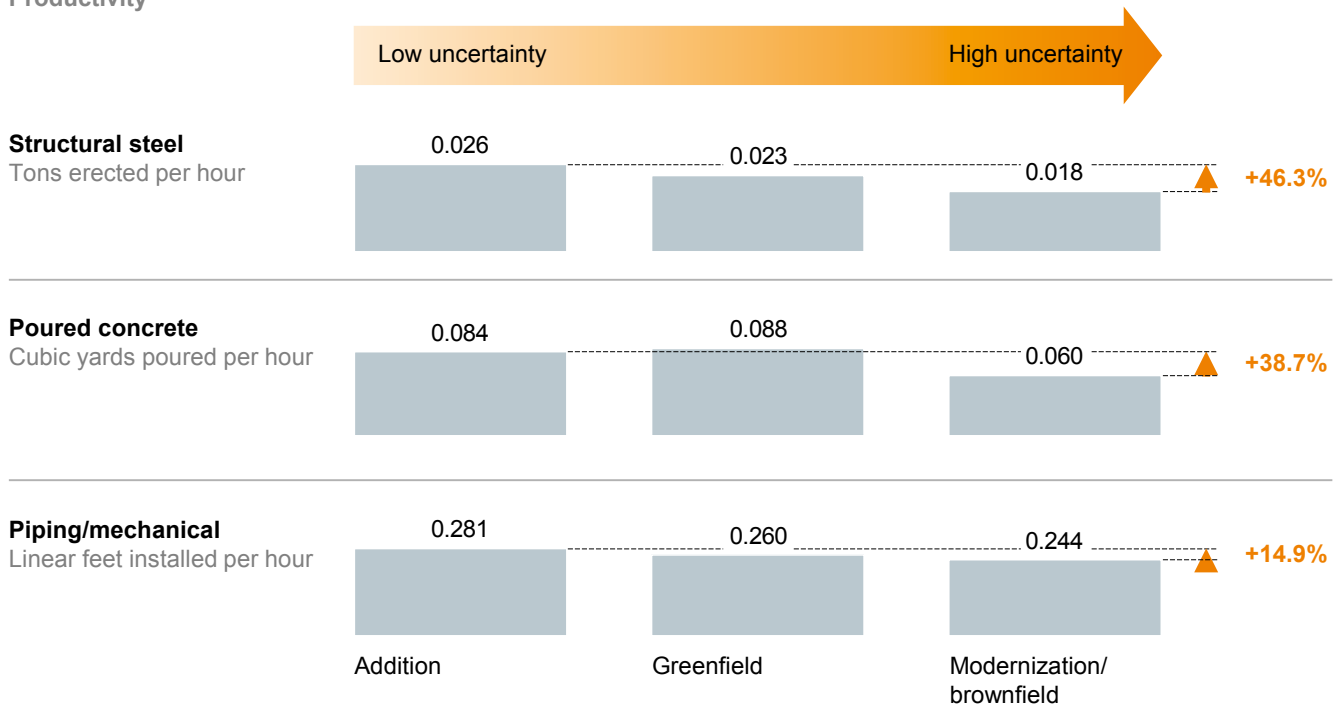

SOURCE: Construction Industry Institute Performance Assessment System; McKinsey Global Institute analysis

As more of the world's resources are exhausted, their extraction tends to shift to more remote (and often politically less stable) environments. As work shifts to remote locations, geological complexity and logistical challenges also dampen productivity. The cost of building a copper mine has risen 18.6 percent a year since 2000, for instance, and half of that increase is due to greater geological complexity. Remote project sites also increase the cost of infrastructure and logistics, as well as the time it takes to get a project done; it is also more difficult to recruit on such sites.²⁵ More remote projects have lower success rates, higher cost overruns, and higher operability failures.²⁶

Root cause 2: The construction industry is extensively regulated, land is fragmented, and the industry is highly dependent on cyclical public-sector demand

Construction is one of the world's most highly regulated sectors. In the United States, for instance, the sector is estimated to be subject to seven times the number of laws directly or indirectly affecting its activities as agriculture or mining (Exhibit 24). Some of these regulations have not changed for decades or longer, as it is politically highly challenging to amend them. The amount of regulation alone is not necessarily the problem—and of course it is important for construction to have a robust regulatory framework so that consistently safe structures are built. Rather, the confusing and arduous bureaucratic processes through which regulation is administered cause delays and compromise coordination among owners, construction firms, and regulators. According to the Construction Industry Institute's benchmarking database, projects that experienced a "higher than planned for" regulatory burden had, on average, 13.8 percent slippage. The uncertainty introduced by regulation not only lengthens the time span of the project—weeks or months can be spent waiting for approvals—but also may make it difficult for firms to invest adequately in equipment that might not be used as planned.

There are several types of challenging regulation in construction. Respondents to the MGI Construction Productivity Survey ranked permitting and approvals as the most challenging form of regulation to manage. According to the World Bank, the global average permitting time is 160 days, with companies in six countries spending more than a year and those in two countries spending more than two years to navigate the process.²⁷

Assembling land is another problematic area where regulation hinders productivity. A patchwork of outdated zoning codes, fragmented land ownership, and extensive review processes makes it very difficult for developers to assemble land quickly and build on a large scale, and therefore limits their ability to standardize and modularize construction designs.

Adding another layer of complexity to such regulatory issues is that the public sector is a major purchaser of construction, and companies are therefore constrained by public demand and the associated public procurement process. Government contracting is notorious for being extremely strict in terms of both what should be built and how it should be built. It is extremely challenging for firms to adopt innovative and productivity-improving approaches when they are afforded relatively little flexibility to do so. Government construction works also tend to be cyclical—usually procyclical, in contrast to what macroeconomic theory suggests—adding to the boom-bust cycles of the industry that make it difficult to invest and retain qualified staff.

²⁵ Where regional data are available, more remote areas (such as Hawaii in the United States and the Northwest Territories in Canada) often have higher productivity in traditional economic measures. This does not necessarily reflect an increase in project-level productivity (for instance, tons of steel erected per hour). It results from labor constraints in those areas that mean that workers are typically paid higher wages, and new approaches may be employed because there is less low-skilled, low-wage labor available.

²⁶ Edward W. Merrow, *Industrial megaprojects: Concepts, strategies, and practices for success*, Wiley, 2011.

²⁷ World Bank Dealing with Construction Permits database 2016.

Exhibit 24

The construction sector has long been more regulated than other sectors, and this is becoming even more the case

US federal regulations directly impacting industry

Number of cited regulations, with 95% probability they apply to industry

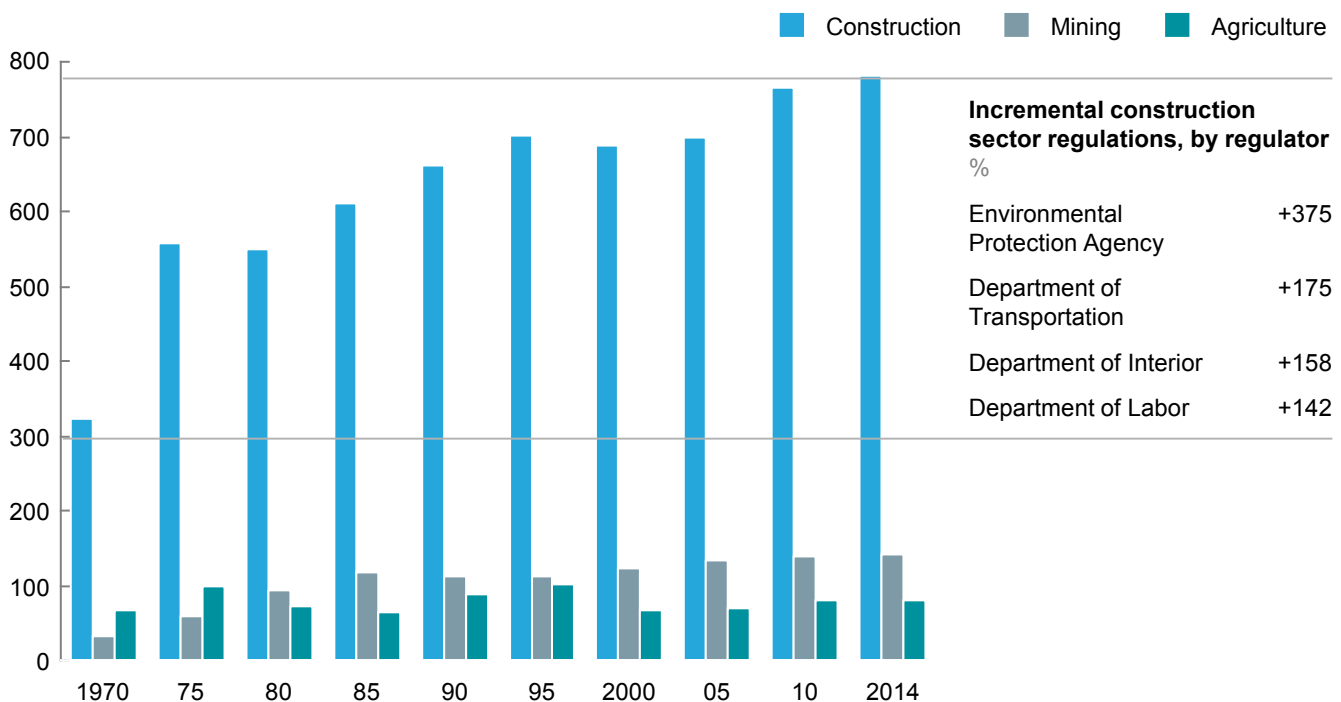

SOURCE: RegData; McKinsey Global Institute analysis

Root cause 3: Informality and the potential for corruption distort the market

One of the most problematic symptoms of the complex regulation and bureaucracy that we have discussed is the prevalence of informality and the potential for corruption that is reinforced by the numerous approvals, inspections, and permits required, many of which come with hefty fees. At every step, there is an opportunity for bribery or payoffs, and the sheer number of procedural gates makes concealment that much easier. These and other factors contribute to construction being the source of the second-highest number of bribery cases globally (only extraction industries have more).²⁸

According to the World Bank's ease of doing business index, in many countries with low levels of corruption and informality, including, for instance, Australia, Denmark, New Zealand, and Singapore, the number of permits required is low and the time to approval is short—in some cases less than a month.²⁹ In these countries, dealing with permitting adds only 0.2 to 0.5 percent of the cost of building a warehouse, for instance. Contrast this with economies such as Brazil, India, and Nigeria that have large informal sectors where permitting delays can stretch for more than a year and the added costs can climb to as much as 25 percent of the building's value. In such countries, the easiest way to expedite the process often is bribery.

In addition, access to informal labor may weaken incentives to invest in workers and their skills. In many countries, foreign-born labor makes up a significant part of the construction workforce. While most of these workers are legal, informal labor can also play a significant

²⁸ OECD foreign bribery report: An analysis of the crime of bribery of foreign public officials, OECD, December 2, 2014.

²⁹ World Bank's ease of doing business ranking.

role. Over the past decade in the United States, informal labor has made up 10 to 15 percent of the workforce, peaking at around 16 percent at the height of the housing boom.³⁰ More than 20 percent of the construction workforce in five US states (California, Maryland, Nevada, New Jersey, and Texas) and the District of Columbia is informal. In the United States, these workers are primarily engaged in building construction, in which projects are on a smaller scale and subject to less scrutiny than civil and industrial projects. Without the same legal protections or contracts, these workers are more transient and companies are unlikely to provide training programs and other resources to improve their productivity.³¹

INDUSTRY DYNAMICS: INTERSECTING INTERESTS OF OWNERS, CONSTRUCTORS, AND SUPPLIERS IN A FRAGMENTED MARKET ARE CHALLENGING

Construction is a highly fragmented industry. This not only prevents players from attaining the size they need to achieve scale benefits leading to higher productivity, but also means that coordination among different players, each with their own vested interests, is difficult, and this can make it harder to deliver a project on time and on budget. The fragmentation also means that there are major information asymmetries among players. Here, too, we have identified three distinct root causes.

Root cause 4: Construction is opaque and highly fragmented horizontally and vertically

Fragmentation in the construction sector is widespread and prevents the development of sufficient critical mass among players necessary to catalyze major change. In Europe, firms with more than 250 employees account for less than 1 percent of all construction companies and contribute 21 percent to the sector's output, while 94 percent of firms have fewer than ten full-time equivalent employees and contribute 39 percent to the total output of the sector. In short, European construction is dominated by small, trade-based firms and subcontractors that are often relatively unsophisticated. This fragmentation means no firm is large enough to pioneer and lead major innovations, and there is a lack of competitive pressure. Small firms are often comfortable quietly going about their business in their local area, neither disrupting nor being disrupted. A similar picture emerges in the United States. The top four firms in the US construction sector control just 6 percent of the market, compared with 14 percent in retail and 42 percent in petrochemical refining, to give just two examples. If the next 16 largest firms are also taken into account, the fragmentation is even more pronounced. The top 20 firms account for only 8 percent of the market, compared with 18 percent and 94 percent in retail and petrochemicals, respectively.

Even within construction, it appears that the degree of fragmentation has a significant impact on productivity (Exhibit 25). Smaller specialty trade segments and remodelers are the most highly fragmented and have the lowest productivity. In contrast, the construction of oil and gas pipelines is both highly consolidated and highly productive.

An industry that is fragmented, is geographically dispersed, and delivers highly customized solutions meeting bespoke requirements also ends up being very opaque. In most countries and sectors, it is nearly impossible to find good benchmarking data on project cost or performance of contractors. Small- and medium-sized buyers in particular cannot easily shop around for the best firm and may have to settle for a local firm whose expertise, pricing, and techniques are difficult to compare with those of their competitors. This acts as a disincentive to players in the industry to improve their productivity as a source of competitive advantage.

³⁰ Jeffrey S. Passell and D'Vera Cohn, *Share of unauthorized immigrant workers in production, construction jobs falls since 2007*, Pew Research Center, March 26, 2015.

³¹ *Immigrant workers in U.S. construction: Sharing lessons learned in our unions*, Center for Construction Research and Training, Labor Occupational Health Program, University of California, Berkeley, 2010.

Exhibit 25

Fragmentation level among subsectors of construction is strongly related to their productivity

Level, 2015

2012 \$ per employee

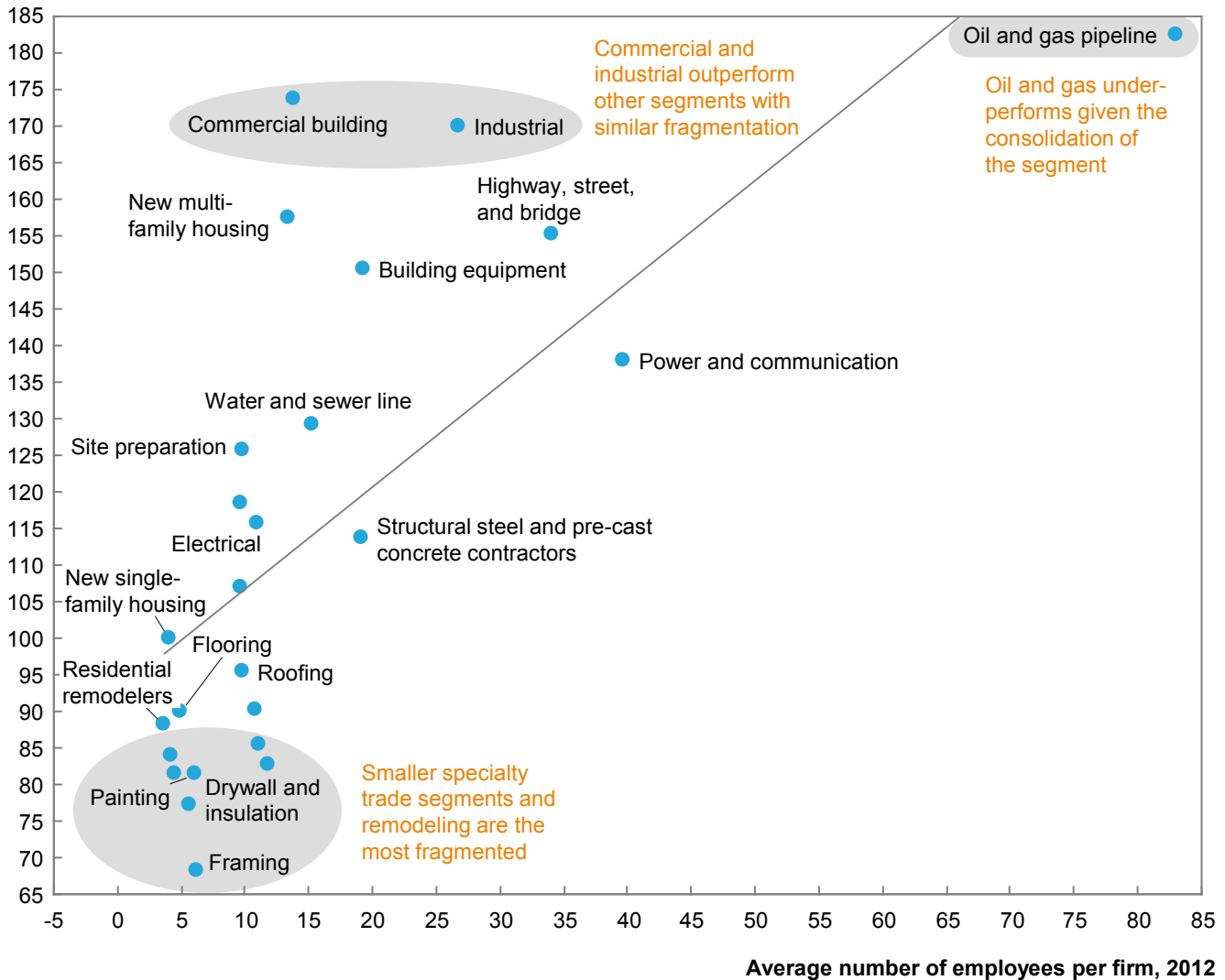

SOURCE: US Economic Census; McKinsey Global Institute analysis

Root cause 5: Contractual structures and incentives are misaligned

The structure of contracts is one of the highest barriers to greater productivity in the construction industry. Penalties, risks, and rewards during the contract process affect participants differently, and this leads to risk aversion and less collaboration. Without improving contracting throughout the industry, progress toward a common goal of higher productivity will be almost impossible. Unintended behavior can result from some of the common incentives found in construction contracts (Exhibit 26).

Contracting structures are closely linked to productivity. As an illustration, compare lump-sum and cost-reimbursable contracting. The evidence suggests that on-site productivity is higher when the former rather than the latter is in place on-site. Because the contractor shoulders the risk in a lump-sum environment, it has an incentive to complete the job as efficiently as possible with high productivity. In a range of on-site disciplines including steel erection, concrete pouring, piping, and wiring, projects using lump-sum contracts

rather than cost-reimbursable ones had 35 to 88 percent higher productivity (Exhibit 27). The Construction Industry Institute has identified 12 points of difference between the two approaches.³² One of the most important was the extent to which owners were involved in all stages of the project, working with contractors to monitor progress, troubleshoot, and mitigate risks. However, the differences between the two contractual approaches are not binary—they are more complex. Lump-sum contracts are typically used on simpler projects that are more predictable and straightforward, and therefore have higher productivity. Cost-reimbursable contracts are more likely to be used on large projects with many stakeholders where time frames—and even the exact form of the final output—may not be fully known when the contract is signed despite the fact that, in many cases, they might be broken down into smaller, more repeatable projects.

Exhibit 26

Incentives under more traditional contracting structures, such as EPC and DBB, inevitably lead to clashes¹

Players	Motivation	Clashing behaviors
Owner	Reliably deliver project in timely fashion	▪ Constantly push contractors and suppliers to expedite production and delivery; engage expeditors for critical path items
	Receive value for money	▪ Seek cost savings throughout (e.g., contractors, suppliers, labor, utilities, etc.)
	Avoid high-profile setbacks or failures	▪ Engage best contractors and offload complete risk onto them
Main contractor	Maximize profit margin	▪ Charge for any scope changes and submit claims, variations, and project extensions
	Ensure financial stability	▪ Get milestone-based payments; stall work until installment is paid
Designer/architect	Illustrate creative edge and reputation	▪ Submit drawings and designs in random order and not the way required by construction contractors
	Minimize effort and resources	▪ Work according to their own resource availability and timeline, rather than under project timelines
Subcontractor	Optimize resources	▪ Deploy cheapest available labor and machinery; in case of any issues, submit claims
Materials supplier	Financial stability	▪ Make high margin on raw materials, logistics, etc.
OEMs² for long lead items	Financial stability	▪ Try to sell technology or product that is most profitable instead of the most appropriate solution for owner
Other equipment supplier	Maximize profit margin	<ul style="list-style-type: none"> ▪ Squeeze subcontractor cost by negotiations, claims, variations, and project extensions ▪ Low motivation to adhere to quality, health, safety, and environment standards unless tight third-party inspection done by main contractor or owner

1 Engineering-procurement-construction and Design-Bid-Build.

2 Original equipment manufacturers.

SOURCE: McKinsey Global Institute analysis

³² C. L. Menches, J. Chen, and K. A. Hull, *Factors that differentiate reimbursable contracting from lump sum contracting*, Construction Industry Institute research report 260-11, 2012.

Exhibit 27

Projects that use lump-sum contracting methods have higher productivity on several measures

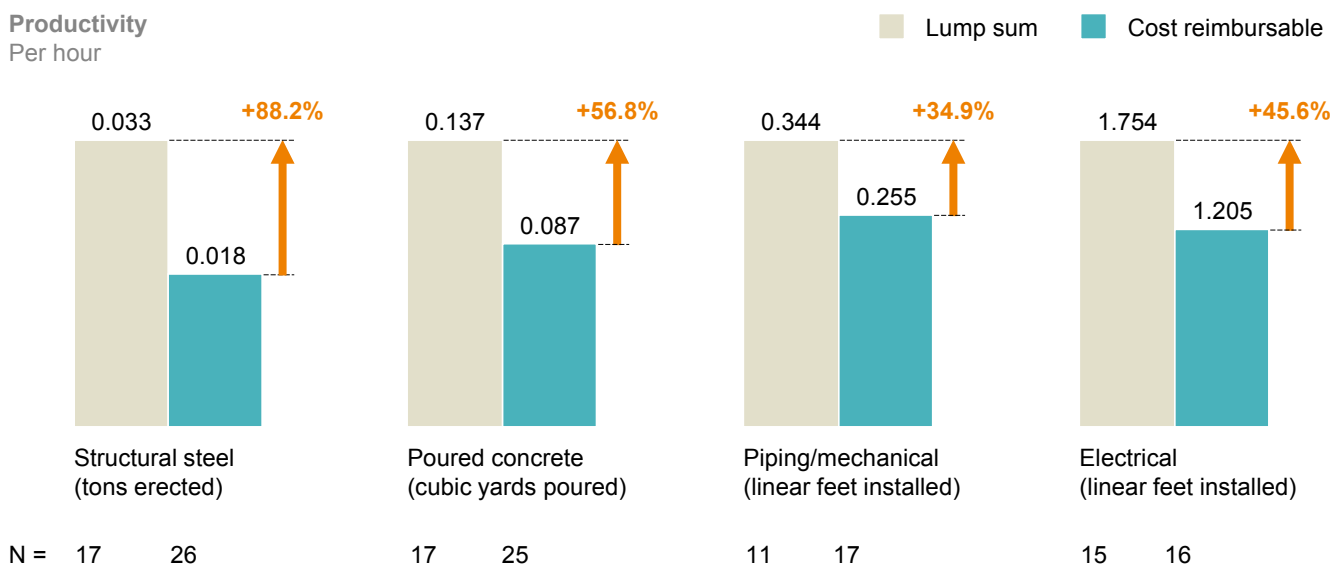

SOURCE: Construction Industry Institute Performance Assessment System; McKinsey Global Institute analysis

These dynamics make it impossible to promote a single universal contract model, but they do suggest that owners and contractors should actively consider the trade-offs of risk, incentive, and productivity when designing contractual structures, and try to ensure that these considerations are balanced.

The key issues related to contracting structures identified by respondents to MGI's Construction Productivity Survey were the hostility, litigation, risk aversion, and lack of transparency and trust that are endemic to competitive contracting; the ineffectiveness of contract structures in accounting for project uncertainty; and the lack of effective risk allocation among stakeholders. But when stakeholders are focused on legal arrangements and how to file claims and contain risk, productivity increases take a back seat. The survey also revealed that contractors were significantly more likely to identify contracts as a leading root cause than were owners (Exhibit 28).

When tendering is solely focused on cost, contractors tend to have a win-at-all-costs mentality that may lead to behavior such as knowingly submitting bids that may not be feasible and may require costly rework, or to an overly risk-averse approach in which a player searches for the safest solution when potentially game-changing innovations may be available. Too often contracts fail to give adequate consideration to the uncertainty of a construction project. They are therefore inflexible and stand in the way of appropriate risk taking, including trying new productivity techniques and materials.

Finally, current contracting structures do not share risk effectively. Both lump-sum and cost-reimbursable contracts take a decidedly binary approach to apportioning risk. When a single party holds a majority of the risk, a concerted team effort to improve productivity and the project outcome will be more difficult, and the party holding the risk will tend to favor more conservative approaches over innovation.

Exhibit 28

The negative impact of misaligned contractual structures weighs heaviest on contractors

Impact of misaligned contracts
% naming this as top three driver

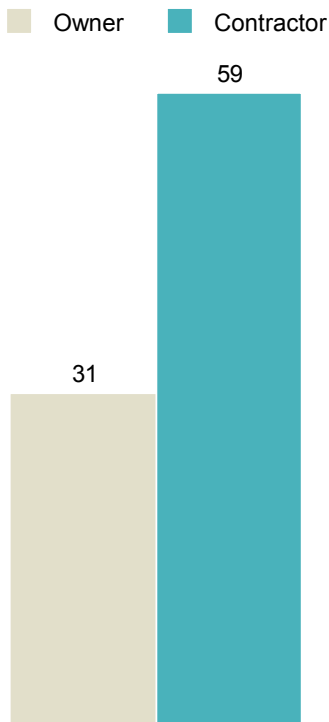

Misaligned contractual structures



Relative importance of drivers of misaligned contractual structures
Impact score¹

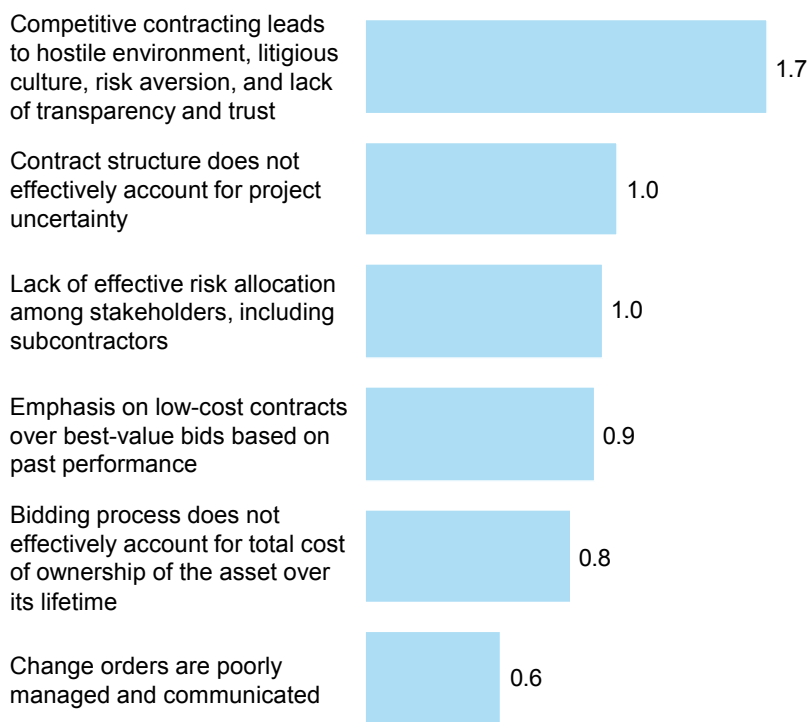

¹ Respondents were asked to rank the three most important drivers. A score of 3 was given to the driver ranked first, a score of 2 to the second, and a score of 1 to the third. Drivers not ranked in the top three were scored as zero.

SOURCE: MGI Construction Productivity Survey; McKinsey Global Institute analysis

Root cause 6: Bespoke or suboptimal owner requirements

Inexperienced owners and buyers are vulnerable to suboptimal work in a sector that is both considerably fragmented and highly opaque, making it difficult to find the best contractors and hold them accountable for their performance.

In all types of construction, owners are typically not well versed in optimal procurement practices nor in design requirements. In the residential sector, the interface between owners and constructors (especially in single-family housing) may occur only once or twice in a lifetime. In civil construction, procurement happens more often for typical items like roads, but much less frequently for large projects like airports. Relationships among owners or buyers and construction companies are usually much stronger in the industrial sector, but there are still challenges for small and medium-sized industrial companies that may undertake a site extension once in a decade. With projects undertaken so infrequently, there is insufficient experience to ensure that the construction services bought are the most appropriate, efficient, and cost-effective.

Owners also often have—or are believed to have, given the absence of standardized options—bespoke requirements. Examples include a house with a unique design and perfectly matched to the shape of the land plot, and an industrial structure optimized for a specific process. This makes the key driver of productivity gains—standardization and repeatability—difficult (see our discussion on design).

FIRM-LEVEL OPERATIONAL FACTORS: THE INDUSTRY LACKS FUNDAMENTAL EXECUTION CAPABILITIES

Even if the external environment were fully optimal and the industry's dynamics fluid and easily navigable, many individual firms would still struggle to improve their productivity because of a lack of fundamental execution capabilities. Constructors need to devote as much attention to their internal processes and organization as they do to the external operating environment. We have identified four root causes.

Root cause 7: Design processes and investment are inadequate

Construction design has a number of inefficiencies, including a lack of standardization and large gaps between design and construction due to delays and limited continuity.

The industry does not tend to reuse designs, and therefore is inclined to offer bespoke solutions to every customer. There are insufficient standardized options for owners, and those owners often do not have large enough portfolios to demand or justify investment in standard designs. This prohibits the sector from more effectively incorporating modular components into design. Since 2000, modularization of designs has risen by less than 5 percent, from 1.7 percent to 6.2 percent.³³ This matters because standardization and modularization each have a significant effect on productivity.

In residential housing, developers that build on spec typically use a handful of designs that are highly repeatable and usually constructed on a large scale in major subdivisions. However, traditional single-family home builders use entirely custom designs and build one house at a time. Unsurprisingly, developers are more than three times as productive as single-family home builders (Exhibit 29). LGI Homes, for example, is a large US home builder that builds 100 percent to stock and has a much higher return on invested capital than the industry average. LGI has managed to maintain high margins through minimizing modifications, which allows consistent blueprints and the ability to have an even-flow construction timeline of 60 days from start to finish.

In housing, there is a perception that repeatable design is bland and generic, and that this reduces demand for standard housing in many more affluent and even middle-class residential areas. The same misgivings are evident in civil construction where there are ample opportunities for public comment and design approvals prior to beginning major infrastructure works. There is a bias against uniform, standard designs and in favor of attractive bespoke options. However, more recent construction with replicable designs has demonstrated that the resulting buildings can be aesthetically pleasing. Google, for example, is moving ahead with a new headquarters in Mountain View, California, which will employ modular construction and reconfigurable space while appearing from a distance to be an architectural focal point for the entire area.³⁴ Other factors weighing against replicable development on a large scale include land fragmentation, highly varied building codes, and fragmentation among owners, contractors, and materials suppliers.

Another design-related issue militating against higher productivity is a large gap in time between a final design and the completion of a project. Owners may be unable to visualize or sufficiently understand the implications of different designs at an early stage. Alternatively, projects may continue for so long that a change of approach is needed or the leadership of a project changes, bringing new choices. For instance, such problems can arise in the construction of a hospital. Medical technology is evolving so rapidly that, by the time shovels hit the ground, the technical requirements needed to deliver a high quality of care may not have been met.

³³ Construction Industry Institute Performance Assessment System.

³⁴ City of Mountain View.

Exhibit 29

The benefits of scale and standardization are evident when comparing different types of residential construction

Construction labor productivity by type of residential construction, 2012

Annual real value added per employee
\$ thousand, 2015

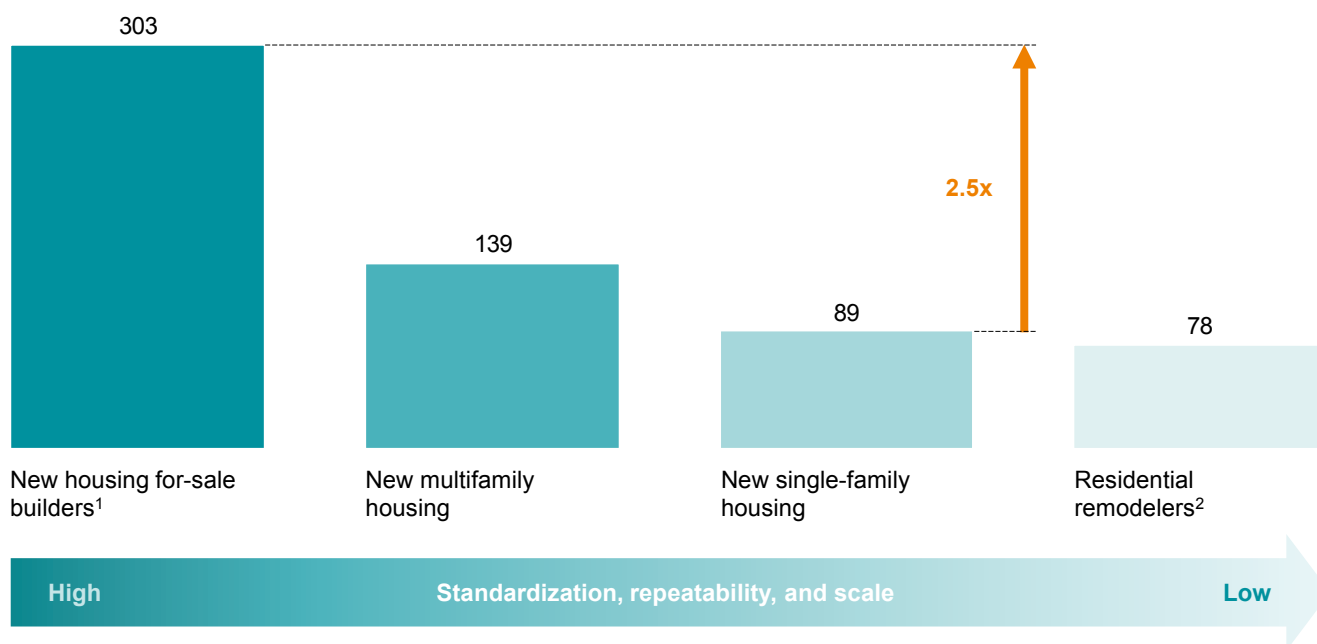

1 Establishments primarily engaged in building new homes on land that is owned or controlled by the builder rather than the home buyer or investor, often referred to as merchant builders, but are also known as production or for-sale builders.

2 Establishments primarily responsible for the remodeling construction (including additions, alterations, reconstruction, maintenance, and repair work) of houses and other residential buildings, single-family, and multifamily.

SOURCE: US Economic Census; McKinsey Global Institute analysis

On the whole, construction firms do not spend enough time getting the design of a project right the first time. Errors in designs—and inefficient designs—have a cascading effect throughout the project that seriously inhibits productivity. In the MGI Construction Productivity Survey, respondents who cited inefficient design as an important root cause attributed this to a lack of stakeholder collaboration and insufficient emphasis on planning. Constructability reviews are an important component of planning.³⁵ The Construction Industry Institute’s benchmarking data underscore the importance of such a step, indicating that projects that conduct constructability reviews reduce schedule slippage by 1.3 percentage points and cost slippage by 2.4 percentage points, compared with projects that do not undertake a constructability review. In Europe, those who invest more in architectural, engineering, and technical testing as a proportion of sector output have demonstrably higher productivity. In Norway, where the industry invests 30 percent of output on such testing, the gain is almost \$20 an hour compared with Sweden, which spends 21 percent (Exhibit 30).

Inadequate attention to design and engineering leads to project delays and overruns, and high levels of change orders that directly affect the ability of a constructor to deliver a functional asset to its owner on time and on budget. According to the Construction Industry Institute’s project benchmarking data, projects with zero or negative schedule slippage devote 29 percent of project time to front-end planning, while those with more than

³⁵ Using this project-management technique, construction processes are reviewed from start to finish during the pre-construction phase, the aim being to identify obstacles before a project is actually built to reduce or prevent errors, delays, and cost overruns.

10 percent schedule slippage devote 25 percent to such planning, on average. Among the causes of increased change orders are many amendments to designs after constructability reviews due to unforeseen field conditions or changes in the sequence of construction imposed by on-site events; errors or omissions in the original design due to inadequate understanding of what the owner is using the building for, drawing conflicts, and requested project changes; requests for rework because of initial errors; a lack of clarity among parties on a project's objectives, execution, or intended outcomes; additions or deletions of work from the original scope; and insistence on new or different processes or plans based on a review of the design, technological advances, or value engineering.

Exhibit 30

Increased spending on design and engineering correlates with a higher level of absolute productivity in the construction sector

Construction sector labor productivity

Gross value added per hour worked, 2009
2005 %

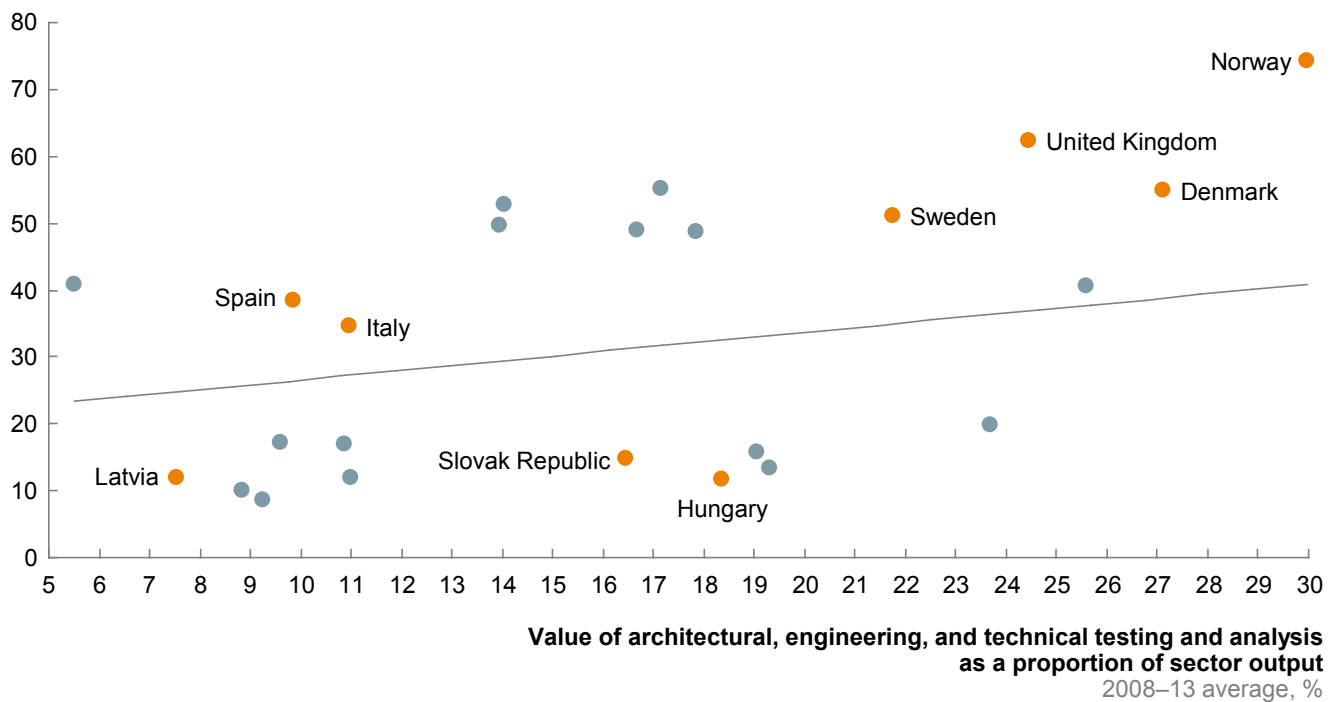

SOURCE: Eurostat annual detailed enterprise statistics for services and construction (NACE Rev. 2); WIOD; McKinsey Global Institute analysis

Root cause 8: Poor project management and execution basics

Projects suffer from major time and cost overruns due not only to insufficient attention to design at an early stage, but also to an inability to execute projects effectively. Construction firms need to pay much closer attention to effective project management and execution of projects; too often, poor communication, a lack of sufficient and deliberate front-end loading, and low adherence to collaborative planning processes lead to high levels of change orders during the life cycle of projects. This drags down productivity by forcing work stoppages, necessitating rework, and disrupting flows of materials and labor.

It is often the transition from planning to construction that goes poorly and sets the entire project execution up for failure. According to Construction Industry Institute benchmarking data, projects that actively incorporate “planning for startup” into their project management plan on average reduce schedule slippage by 5.6 percentage points and reduce cost slippage by 7.9 percentage points, compared with projects that do not have a startup plan in place.

Root cause 9: Insufficiently skilled labor at the frontline and supervisory levels

There is a mismatch between the demands of the construction sector and the capabilities of the available workforce. Around the world, the labor pool in the construction sector is aging and low-skill, which makes implementing the changes necessary for achieving significant productivity improvements more challenging unless moving to full automation. There is a large share of low- and medium-skill workers in the sector.

Respondents to the MGI Construction Productivity Survey ranked low-skilled labor as the third most important root cause after poor designs and contracting structures. It was a particularly important issue for owners, who, on average, ranked the issue of low-skilled labor 15 to 20 percent higher than contractors did. This suggests that contractors may need to pay more attention to developing their workforce in order to assuage the concerns of the clients they serve.

There is a chronic lack of vocational and on-the-job training in the sector that would move workers from the low- to medium-skill category. In Europe, construction is in joint last place (with real estate activities) for sector provision of continuous vocational training hours, at five hours per thousand worked. The information, communication, and finance sector devotes more than double that amount—11 hours per thousand—to continuous training.

There has been some progress. Between 1995 and 2005, there was a decline in low-skilled labor in the sector in many advanced economies of between 2 and 9 percent. The exception was the United States, which experienced a 2 percent rise in low-skilled workers in that period.³⁶ However, the share of low- and medium-skill workers in the sector remains stubbornly high, exacerbated by the fact that construction employees are the least likely of any type of worker to have graduated from secondary school, at 77 percent. The shortage of skilled people is acute at the project-manager level. This is not solely an issue with frontline workers. Construction company owners are the least likely of any sector to have a technical or college degree, at 31 percent in the United States.

Compounding the industry's skills problem is the fact that the construction workforce is aging, which hinders the adoption of more productive digital and other innovative construction techniques (see the next section for further discussion of digitization). The sector's share of employees aged 45 years or older increased from 32 to 50 percent between 1985 and 2010. Older workers are less likely to be receptive to the training necessary to implement the latest technology.³⁷ One factor that appears to be in play is that the industry has an image of being dull among the latest generation of top-talent engineers and interdisciplinary managers who can run projects of substantial complexity, and they appear to prefer to use their talents elsewhere.³⁸

Although the sector has a large share of workers with low skills and has low productivity, in Europe wages have still typically risen. Consequently, between 1995 and 2015, unit labor costs (the amount of money paid for a unit of labor output or the increase in wages minus the increase in productivity) grew at a compound annual rate of 2.4 percent in construction, compared with 1.3 percent in manufacturing and only 0.3 percent in services. A similar gap in wage change and productivity occurred in US construction where wages have been stagnant or declining since 1973. Nevertheless, even in the United States, wages declined by less than productivity over this period. The combination of low skills, low productivity, and

³⁶ World KLEMS; after 2005 this information was no longer tracked using the same classification.

³⁷ See, for example, Thomas W. H. Ng and Daniel C. Feldman, "Evaluating six common stereotypes about older workers with meta-analytical data," *Journal of Personnel Psychology*, November 1, 2012.

³⁸ See, for example, F. Yng Ling, X. Leow, and K. Lee, "Strategies for attracting more construction-trained graduates to take professional jobs in the construction industry," *Journal of Professional Issues in Engineering Education and Practice*, volume 142, issue 1, January 2016.

rising wages should be sufficient incentive for firms to address the industry's skills and aging problem, and thereby help to improve productivity.

Root cause 10: Industry underinvests in digitization, innovation, and capital

Even if the sector had a top-notch skilled workforce, construction companies today sorely underinvest in the technology and digital tools that would enable them to achieve significant productivity gains. Construction is among the least digitized sectors in the world, according to MGI's digitization index, which combines dozens of indicators to provide a comprehensive picture of where and how companies are developing digital assets, expanding digital usage, and creating a more digital workforce.³⁹ In the United States, construction comes in second to last, ahead of only agriculture. In Europe, construction is in last position. The index finds that there are particular deficiencies in the sector's ability to use digital tools to facilitate stakeholder interactions and in the rate of growth in digital tools available to the frontline labor force.

The sector's investment in information and communications technology is weak compared with other sectors. In Germany, for instance, the construction sector invested only 0.7 percent of its gross value added a year between 1991 and 2007 in digital assets annually. In comparison, financial intermediation invested 4.3 percent and manufacturing 1.8 percent, and the average of all industries was triple the investment share in construction at 2.3 percent. We observe the same situation in the US construction sector, where 1.5 percent of gross value added was invested compared with 5.7 percent in financial intermediation, 3.3 percent in manufacturing, and the all-sector average of 3.6 percent.

There is a robust correlation between the level of digitization in a sector and its productivity growth over the past ten years (Exhibit 31). On the ground, there are proven examples of companies in construction and in other sectors using digital technologies and achieving large productivity gains. The mining industry uses digital innovations to improve productivity and find new ways to manage variability.⁴⁰ In the 1970s, major aerospace companies pioneered computer-aided 3D modeling that transformed the way aircraft were designed and boosted the sector's productivity by up to ten times. However, the construction industry has yet to adopt an integrated platform that spans project planning, design, construction, operations, and maintenance. Instead, the industry still relies on bespoke software tools. In addition, project owners and contractors often use different platforms that do not sync with one another.⁴¹

There are some examples in the construction sector of the use of digital technologies having had substantial productivity benefits. In a tunnel project in the United States that involved almost 600 vendors, the contractor put in place a single platform solution for bidding, tendering, and contract management. This saved the team more than 20 hours of staff time per week, cut down the time to generate reports by 75 percent, and sped up document transmittals by 90 percent. In another case, a \$5 billion rail project saved more than \$110 million and boosted productivity by using automated work flows for reviews and approvals.⁴²

³⁹ The McKinsey Global Institute's Industry Digitization Index provides dozens of indicators to provide a snapshot of digital assets such as hardware, software, and telecommunications spending and hardware and software assets; uses such as online selling and purchasing, digital supply chains, enterprise resource planning, and customer relationship management; and labor such as digital spending per worker, hardware and software per worker, and share of jobs that are digital. The index was first published in *Digital America: A tale of the haves and have-mores*, McKinsey Global Institute, December 2015.

⁴⁰ *How digital innovation can improve mining productivity*, McKinsey & Company, November 2015.

⁴¹ *Imagining construction's digital future*, McKinsey & Company, June 2016.

⁴² *Ibid.*

Exhibit 31

Lower digitization in construction relative to other industries has contributed to the productivity decline

Digitization index¹
%

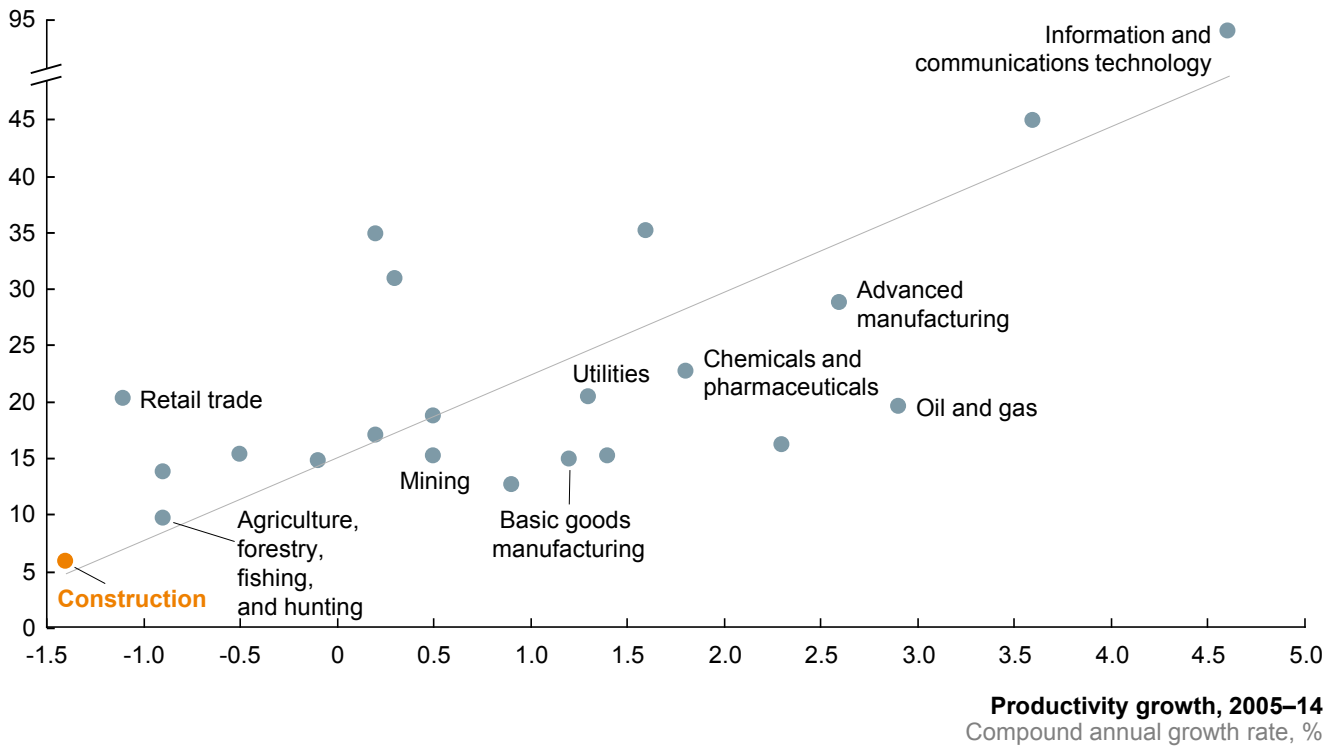

1 Based on a set of metrics to assess digitization of assets (8 metrics), usage (11 metrics), and labor (8 metrics); see technical appendix for full list of metrics and explanation of methodology.

SOURCE: BEA; BLS; US Census; IDC; Gartner; McKinsey social technology survey; McKinsey Payments Map; LiveChat customer satisfaction report; Appbrain; US contact center decision-makers guide; eMarketer; Bluewolf; Computer Economics; industry expert interviews; McKinsey Global Institute analysis



Understanding the root causes of poor productivity in construction is a necessary first step to tackling the sector’s low productivity. The next step is for the industry to consider what to do about it. In the next chapter, we turn to a discussion of levers, focusing in particular on seven broad areas that we believe are most relevant and most likely to have a positive impact on the sector.



CASE STUDY: BRAZIL

Productivity and demand trends. Despite the construction sector’s major contribution to economic growth in Brazil, its productivity has been declining for 20 years. The heavy construction industry, in particular, has experienced huge volatility in demand. It experienced a boom in the 1970s, a scarcity of construction projects in the 1980s and 1990s, and a pickup in demand in the 2000s, driven notably by gas projects. More recently, corruption scandals in the industry have had a negative impact on investment. However, even during construction booms, capital has always been scarcer than labor. Equipment is often rented and laborers hired as they are needed. Given such transient job relationships and an abundance of cheap local labor, in general companies do not invest in capability building. Nor are there effective incentives in place to invest in ways of reducing costs and time on projects, which would lead to higher productivity. Moreover, in order to manage their cash flow, companies will adjust their speed of construction to match the monthly payment installments they receive. Payment delays are not uncommon, increasing companies’ risk of insolvency.

Government interventions and regulatory setup. Brazil’s government has prioritized the reduction of shortages in housing and infrastructure as well as the creation of employment in construction. To address the former,

it launched a growth acceleration program and “my house, my life” initiative in 2007 and 2009, respectively, to build new infrastructure and housing, particularly for low-income families. To address employment creation, it offers tax incentives such as the “payroll exemption” measure to reduce the cost of hiring workers. However, the tax burden for those using more efficient material inputs can be relatively high, especially when they are produced abroad due to import taxes.

Technology investments. Overall, the cost of capital is still high compared with that of labor. There is too much volatility in demand, which means that companies opt for the most flexible input—labor. A large percentage of Brazil’s construction sector is informal, reducing companies’ access to the credit they require to invest in technology. Investment in machinery in a bid to replace labor has not significantly improved efficiency, because the production process was often not modified—machines continue to lay one brick at a time, for example. Companies that do want to invest in new methods and technology need these to be tested and approved by government agencies, which can be time-consuming. A shortage of labs to test materials and equipment further discourages innovation; companies that can afford it pay for private and foreign labs to test materials.¹

Productivity evolution, 1995–2011
Gross value added¹ per hour worked
Index: 100 = 1995

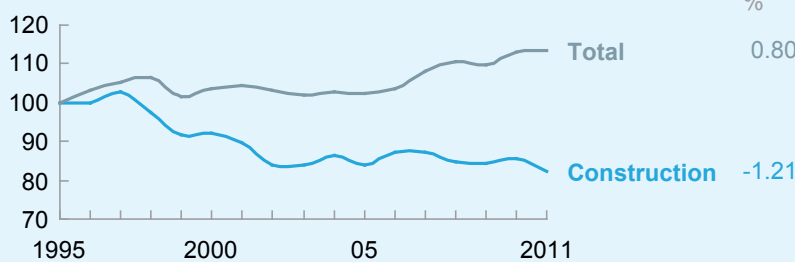

Compound annual growth rate
%

Total: 0.80
Construction: -1.21

Sector size and composition
2015 \$ billion

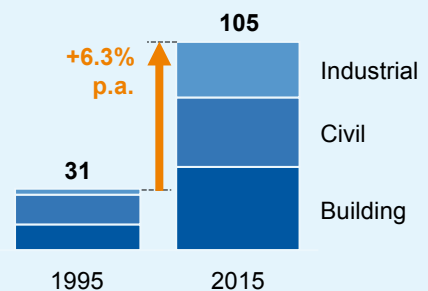

\$4 per hour
2011 construction productivity level

\$5 per hour
2011 average economy productivity level

\$15.7 billion
Annual value lost¹ to low productivity

¹ 2005 USD, non-PPP adjusted

SOURCE: Groningen Growth and Development Centre-10; OECD; World KLEMS; IHS; ITF; GWI; World Energy Outlook; World Bank; Brazil national accounts; McKinsey Global Institute analysis

¹ Construction sector Brazil, EMIS, June 2015.

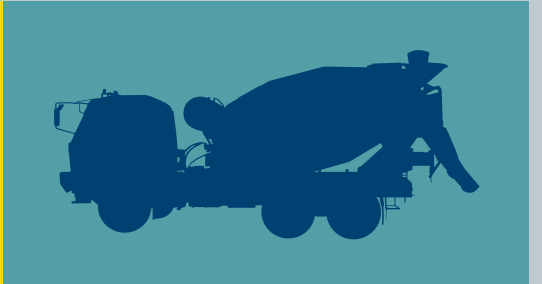
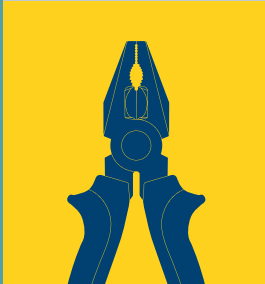
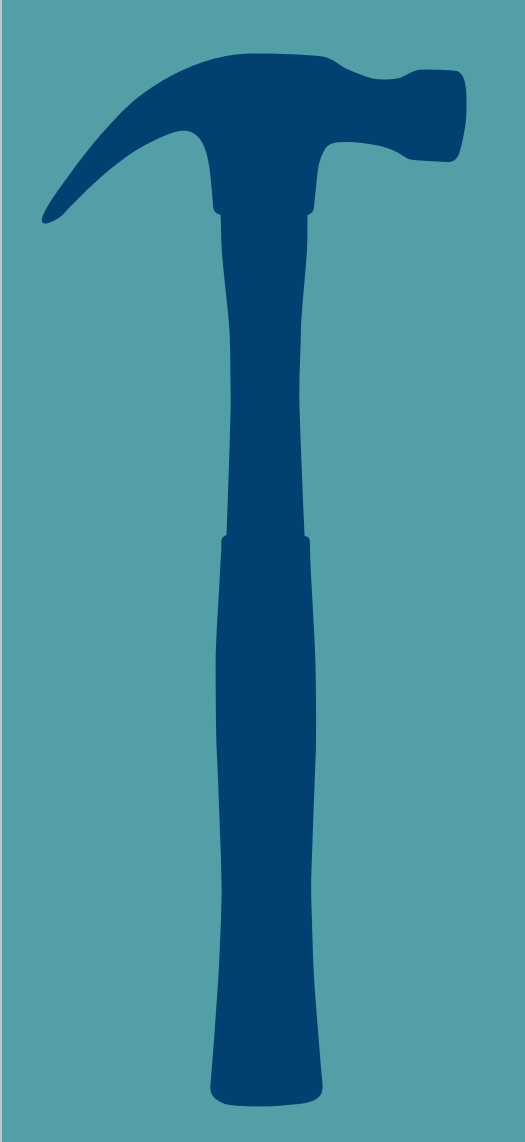
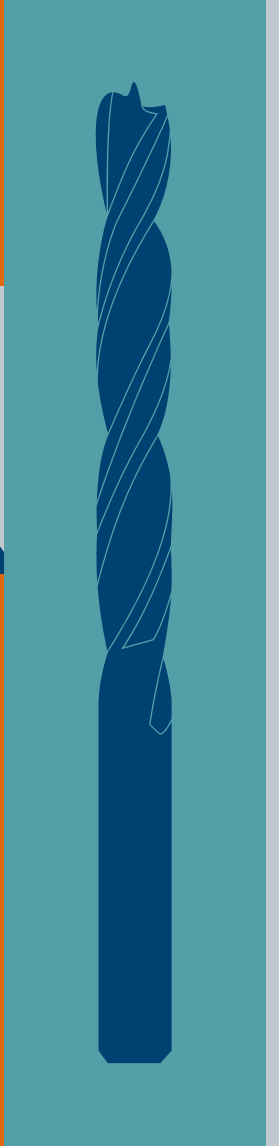
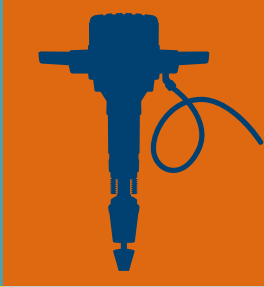



A drone flying and photographing over a road in a mountain valley
© Buena Vista Images/Getty Images

3. SEVEN WAYS TO IMPROVE THE PRODUCTIVITY OF CONSTRUCTION

We have identified seven ways to tackle the ten root causes that underlie the poor productivity growth of both halves of the construction industry. These approaches can reduce cost, improve the reliability of schedules, and raise productivity (Exhibit 32). They are:

- Reshape regulation and raise transparency
- Rewire the contractual framework
- Rethink design and engineering processes
- Improve procurement and supply-chain management
- Improve on-site execution
- Infuse digital technology, new materials, and advanced automation
- Reskill the workforce







These seven ways to improve productivity in the industry will apply differently depending on asset class, geography, level of sophistication of the owner, size of the project, whether it is greenfield or brownfield, and industry player. However, we believe that the industry should pursue these seven priority areas for action simultaneously. The key to improvement is ensuring adoption of a collaborative approach across the industry. Within each of these levers are a series of sublevers to consider, which are summarized in the infographic on pages 64 and 65.

All seven areas for action are significant, but three—reshaping regulation, rewiring the contractual framework to develop a genuinely collaborative approach to construction projects, and rethinking design and engineering processes to leverage the advantages of scale—are key because they enable change in the other four. If the owner, designer, and contractors on a project have a contract that incentivizes their collaboration and allocates risk to the party best placed to manage it, it will be significantly easier to implement improvements in on-site execution and to invest in and roll out technological advances. Similarly, a drive toward simpler and more modular design and engineering will radically streamline procurement and supply-chain management. Finally, regulators set the boundary conditions that can enable scale and innovation.

In Chapter 2 we discussed the two halves of the construction industry. The levers that we discuss here are applicable to both, but to different extents and in different ways.

Exhibit 32

Action in seven areas in combination can address the ten root causes identified

		Primary solution in seven action areas						
		Reshape regulation	Rewire contractual framework	Rethink design and engineering processes	Optimize procurement and supply-chain management	Improve on-site execution	Infuse technology	Reskill the workforce
Root cause								
External forces	Increasing project and site complexities						●	
	Extensive regulation, land fragmentation, and the cyclical nature of public investment	●						
	Informality and potential for corruption distort the market	●						
Industry dynamics	Construction is opaque and highly fragmented				●			
	Contractual structures and incentives are misaligned		●					
	Bespoke or suboptimal owner requirements			●				
Firm-level operational factors	Design processes and investment are inadequate			●				
	Poor project management and execution basics					●		
	Insufficiently skilled labor at frontline and supervisory levels							●
	Industry underinvests in digitization, innovation, and capital						●	

SOURCE: McKinsey Global Institute analysis

We assessed the impact of action in the seven areas by drawing on case studies of the implementation of best practices from around the world, assessing their applicability globally, and considering the current level of adoption to estimate how much of the productivity gap between the construction industry and the total economy in 2015 could be closed by 2030 (see the technical appendix for more detail on our methodology). Our analysis finds that the productivity of the construction industry could improve by between 50 and 60 percent (Exhibit 33). Implementing the various initiatives discussed in this chapter will take time, and we have taken into account current levels of adoption and applicability in our estimates of potential impact. In the rest of this chapter, we look at the seven action areas in turn.

Exhibit 33

Construction can catch up with total economy productivity by taking action in seven areas

Cascading effect

Regulation changes facilitate shifts in industry dynamics that enable firm-level levers and impact

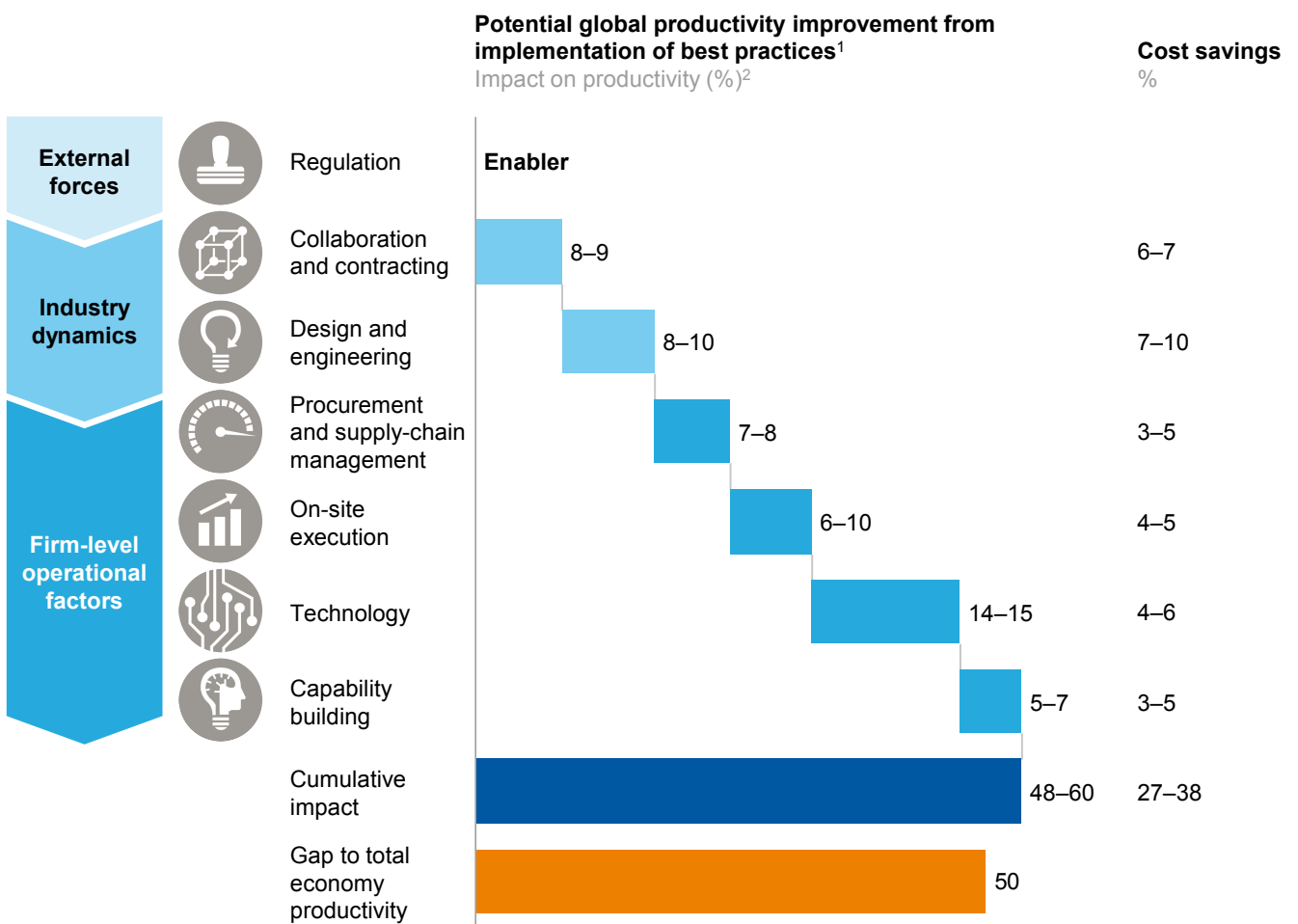

1 The impact numbers have been scaled down from a best case project number to reflect current levels of adoption and applicability across projects, based on respondents to the MGI Construction Productivity Survey who responded “agree” or “strongly agree” to the questions around implementation of the solutions.
 2 Range reflects expected difference in impact between emerging and developed markets.

SOURCE: McKinsey Global Institute analysis

SEVEN LEVERS

TO DRIVE



JUST THE BASICS

RESHAPE REGULATION AND RAISE TRANSPARENCY



- Monitor KPIs across key regulatory areas
- Streamline permitting and approvals processes
- Allocate grants and budgets for innovation and training
- Encourage transparency across the industry and combat informality
- Mandate use of technology (e.g., BIM on all public-sector projects)

REWIRE THE CONTRACTUAL FRAMEWORK



- Negotiate and contract beyond cost for value
- Establish a single source of truth
- Add incentives to traditional contracts
- Prioritize integration and interface management

RETHINK DESIGN AND ENGINEERING PROCESSES AND INCREASE STANDARDIZATION



- Improve design process and outcomes
- Ensure early collaboration from all parties involved in design
- Encourage repeatability of design across projects

IMPROVE PROCUREMENT AND SUPPLY-CHAIN MANAGEMENT



- Use standard procurement tools and levers seen in other sectors
- Invest in a central procurement organization
- Leverage clean sheeting to improve supplier and subcontractor management

IMPROVE ON-SITE EXECUTION IN FOUR KEY WAYS



- Introduce rigorous integrated planning
- Implement collaborative performance management
- Mobilize projects effectively
- Collaborate to reduce waste and variability

INFUSE DIGITAL TECHNOLOGY, NEW MATERIALS, AND ADVANCED AUTOMATION



- Invest in a chief digital/tech/innovation office and team
- Make 3D BIM universal
- Introduce drones and unmanned aerial vehicles for scanning, monitoring, and mapping
- Use digital collaboration and mobility tools on portable devices

RESKILL THE WORKFORCE



- Build an apprenticeship model
- Develop frontline training
- Ensure knowledge retention and management

PRODUCTIVITY IMPROVEMENTS IN THE INDUSTRY

BEYOND THE BASICS

- Shift fully to outcome/productivity-based regulation
- Establish “single-window clearance” approach to optimizing permitting and approvals
- Move from grants to investments in areas such as innovation and skillbuilding
- Combat land fragmentation to drive scale development

- Move to alternative contracting strategies, e.g., IPD
- Invest in up-front planning and scoping, typically with early contractor and expert input from multiple sources
- Formalize contracting and budget only after estimates are robust and triangulated via multiple inputs

- Design for manufacturing and assembly right from the start
- Institutionalize design to value and constructability reviews in design

- Invest in supply-chain and inventory capabilities to tackle the shift to a production system
- Move to digitized procurement-management system, including analytics and simulations, and real-time and predictive supply-chain practices

- Utilize a LPS-based system to ensure effective “milestone-back” workforce planning, in addition to central planning
- Develop a single source of truth with a central control tower, used by all contractors and subcontractors

- Mobilize 5D BIM across the project life cycle, with augmented/mixed reality interfaces
- Leverage the Internet of Things–enabled fully connected sites (e.g., near-field communication, sensors, wearables)
- Implement advanced analytics on project and firmwide data
- Develop alternative and innovative materials
- Implement automation equipment on sites

- Introduce e-enabled microtraining for frontline workers
- Run field and forum—mix of classroom and field-based training to make adult learning more effective
- Create internal academies to institutionalize best practices and roll out across sites

1. RESHAPE REGULATION AND RAISE TRANSPARENCY

Policies governing what—and how—to build provide the framework within which all industry players must operate. The policies have tended to develop over decades or even centuries in a piecemeal, reactive fashion rather than in an organized, forward-thinking way. This has an impact on the effectiveness of the sector and its productivity.

Regulation that ensures that construction is safe and well-planned and delivers on quality is vital, but these aims can be delivered simultaneously in pursuit of higher productivity. Policy can powerfully promote best practices in, for instance, standardization, scale, and investment in innovation. Coordinated measures need to be taken at every level—local, regional, and federal—to achieve effective reform. The International Construction Measurement Standard project, for example, aims to provide global consistency in classifying and presenting construction costs from the individual project to the international level, enabling comparative analysis among countries and providing appropriate benchmarks.

Regulation can also be used to overcome the increasing fragmentation of ownership of buildable areas, which also has substantial negative implications for productivity. Worldwide, the proportion of residential land taken up by “atomistic settlements” (single-family homes) has increased significantly since the last decade of the 20th century, from 22 percent to 31 percent of residential land.

In this section, we propose three ways in which policy makers can improve the regulatory framework for construction. Rather than offering specific policy prescriptions, we focus on what standards should be applied broadly as policy makers consider new legislation.

REPLACE EXISTING REGULATION WITH SMARTER OUTCOME- AND RISK-BASED APPROACHES THAT WILL ENHANCE FLEXIBILITY

Regulation of the construction industry needs to be more flexible. Today, it is highly prescriptive about the choice of equipment, materials, and designs that construction companies use, which makes it difficult to achieve meaningful improvements in productivity by adopting new and innovative practices.

Focus on outcomes instead of requirements

Prescriptive regulation of the construction industry abounds.⁴³ For instance, a prescriptive building code might require specific spacing of wall studs; an outcome-based code would instead require that the wall be able to withstand certain vertical and horizontal forces (see Box 5, “CLT and outcome-based regulation in Singapore”).

⁴³ For a comprehensive introduction to why regulation is important, what outcome-based regulation looks like, and how many countries have already begun their transition toward outcome-based regulation, see Brian J. Meacham, ed., *Performance-based building regulatory systems: Principles and experiences, A report of the Inter-Jurisdictional Regulatory Collaboration Committee, IRCC*, February 2010.

Box 5. CLT and outcome-based regulation in Singapore

CLT is made of perpendicular layers of lumber glued together and has exceptional strength, dimensional stability, and rigidity. It is easy and relatively cheap to install, and therefore greatly increases the productivity of projects in which it is used. Despite these manifold advantages, however, many building codes prohibit the use of CLT on large-scale, high buildings—where it would have the most beneficial impact on productivity—due to the fire risk. In one study of an apartment complex constructed in Australia with CLT, engineers estimated that the build was 30 percent faster than it would have been using traditional poured-concrete construction—and reduced material weight by 80 percent.¹ In light of such benefits, Singapore reviewed its ban on the use of CLT in structures more than 12 meters tall. The Buildings Construction Authority then increased the limit to 24 meters before removing it altogether. Today, Singapore has outcome-based regulation that requires tall residential buildings to be of a certain structural integrity capable of sustaining loads similar to those sustained by metal construction. In part because of this regulatory change, Singapore is home to some of the most productive residential construction projects in the world.²

¹ Daryl Patterson, *Completed 10-storey apartment in Australia: Forte from an owner/development perspective*, Woodworks and Lend Lease, November 6, 2014.

² BCA Awards 2015, Building and Construction Authority, Singapore.

Other countries have moved more generally away from prescriptive building codes in favor of outcome-based regulation. Examples of this new approach include the Eurocode in the European Union (EU).⁴⁴ Outcome-based regulation can be effective in three areas:

- **Building codes and environmental regulations.** Policy makers should change codes to require safe, sound outcomes but give construction firms the flexibility to decide how to achieve them. This would also potentially reduce the impact of geographical differences, allowing contractors to transfer building methods more easily among countries.
- **Local-content regulations.** Regulators should insist on knowledge sharing and capability building for local suppliers rather than constraining a percentage of the labor force to local supply. The aerospace industry has implemented such an approach successfully; for instance, Airbus and Boeing work with the small and medium-sized enterprises in their supply chains to help them develop local capabilities that can deliver global specifications.
- **Health and safety standards.** Productivity losses from on-site accidents are estimated at 4 percent of global gross domestic product every year, and the true figure likely is considerably higher.⁴⁵ “Performance-based” safety regulation in the oil and gas industry is an example of outcome-based safety regulation—requiring a predefined outcome but leaving the means of achievement to the regulated entity. In countries that have implemented such an approach, health and safety has improved on average tenfold.⁴⁶

⁴⁴ A group of ten European standards specifying how structural design should be conducted within the EU. The Eurocodes are written to be performance-based. Starting in March 2010, Eurocodes were mandatory for European public works, but they are not yet required for all private-sector construction.

⁴⁵ *Ibid.*

⁴⁶ Peter Bjerager, *Performance-based safety regulation*, National Academy of Sciences, April 15, 2016.

Reflect risk levels in regulation to accelerate low-risk projects that account for the majority of construction output

There is a significant opportunity for policy makers to align building codes and inspection requirements on the basis of risk—lower-risk structures like single-family homes are subject to less, or more flexible, regulation and inspection requirements, while high-risk structures like a chemical plant would continue to be subject to more stringent regulations and inspection regimes. This would ease the burden for regulators and constructors. Most developed countries already have some form of risk-based regulation in place. One example is European standard EN 1990, which contains three “consequence classes” determined by the risks to users as well as social and economic consequences. Developing countries would benefit from a similar approach.

STREAMLINE REGULATORY PROCESSES AND APPROVALS

Company leaders agree that bureaucracy is a challenge. In the MGI Construction Productivity Survey, respondents identified permitting and approvals as the top regulatory factor inhibiting productivity.

Policy makers should therefore strive to make major improvements to streamline the end-to-end permitting and approvals process. This can be achieved through digitization, for example, with digitized land-use registrations available. Online automation can be used in the case of fee submissions to increase transparency and speed up the process. In addition, the public sector could use more third-party inspectors from the private sector, as the Czech Republic and other entities already do. This can increase the volume of inspections, but it requires that the third parties are highly qualified and subject to oversight. There is also a clear case for subsidiarity, avoiding regulation—and decision making—having to be duplicated at the federal, state, and local levels.⁴⁷

According to the World Bank’s ease of construction permitting index, an entire permitting and approvals process can take more than a year and account for 25 percent and more of the cost of a building in some countries, including India.⁴⁸ This affects productivity through the delays and stoppages caused. The Australian government cut the number of regulatory procedures from 14 to ten and reduced the time it takes to approve building permits by 38 days to 112 days, making it 25 percent lower than the global median, at a cost 72 percent lower, all while maintaining a quality index score 40 percent higher. In the process, it improved its ranking on the World Bank’s ease of doing business index (Exhibit 34).

In Europe, the replacement of most national building standards by standardized and streamlined Eurocodes in 2010 has enabled construction companies to operate confidently across the EU and in some cases even farther afield. Eurocode adoption has been most prevalent in countries that previously used British Standards, such as Kenya and Singapore (Exhibit 35).

⁴⁷ Francis Fukuyama, “Too much law and too little infrastructure,” *The American Interest*, volume 12, number 3, November 8, 2016.

⁴⁸ For detailed explanations of individual regulations in each country and their associated time and cost values, see the World Bank’s Doing Business website.

Exhibit 34

Australia significantly improved its regulation of construction by reducing the number of procedures and increasing the quality of rule-making

Days to complete all permitting and approval procedures by country

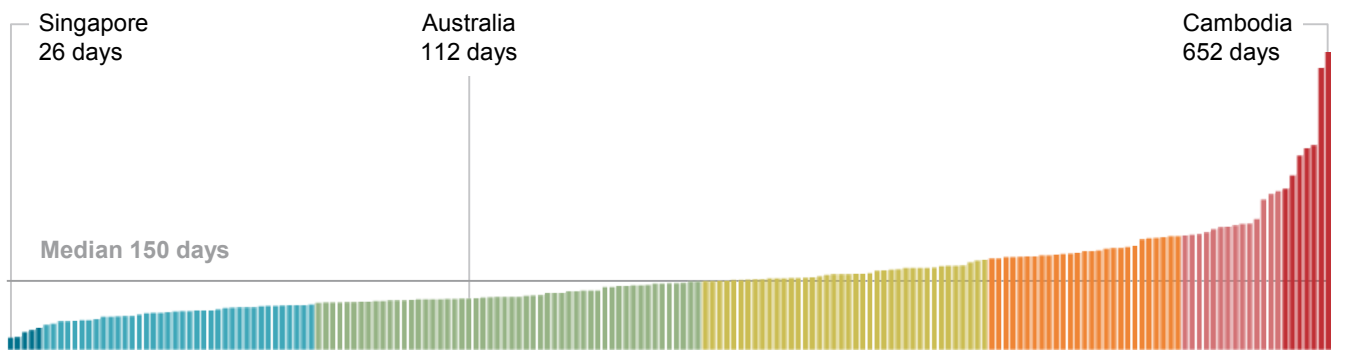
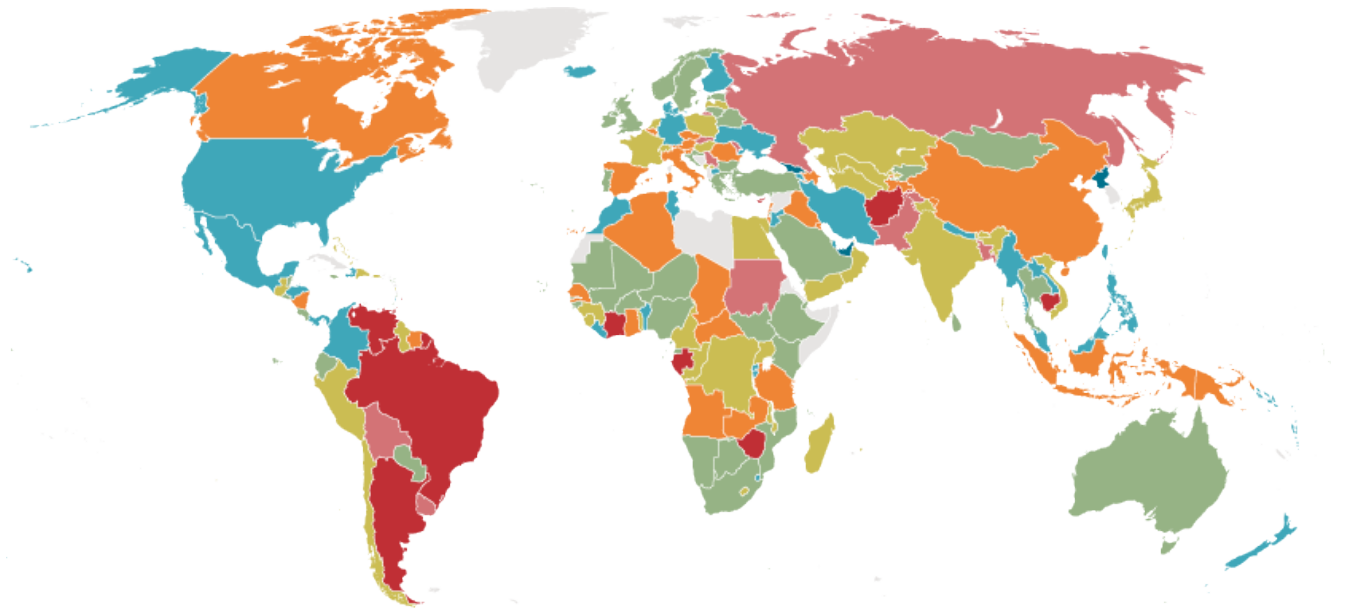

SOURCE: World Bank Ease of Doing Business Report—Dealing With Construction Permits; McKinsey Global Institute analysis

Exhibit 35

Many countries outside the EU use Eurocodes in their construction sectors

- CEN members
- CEN affiliates and countries that adopted or expressed interest in CEN Eurocodes

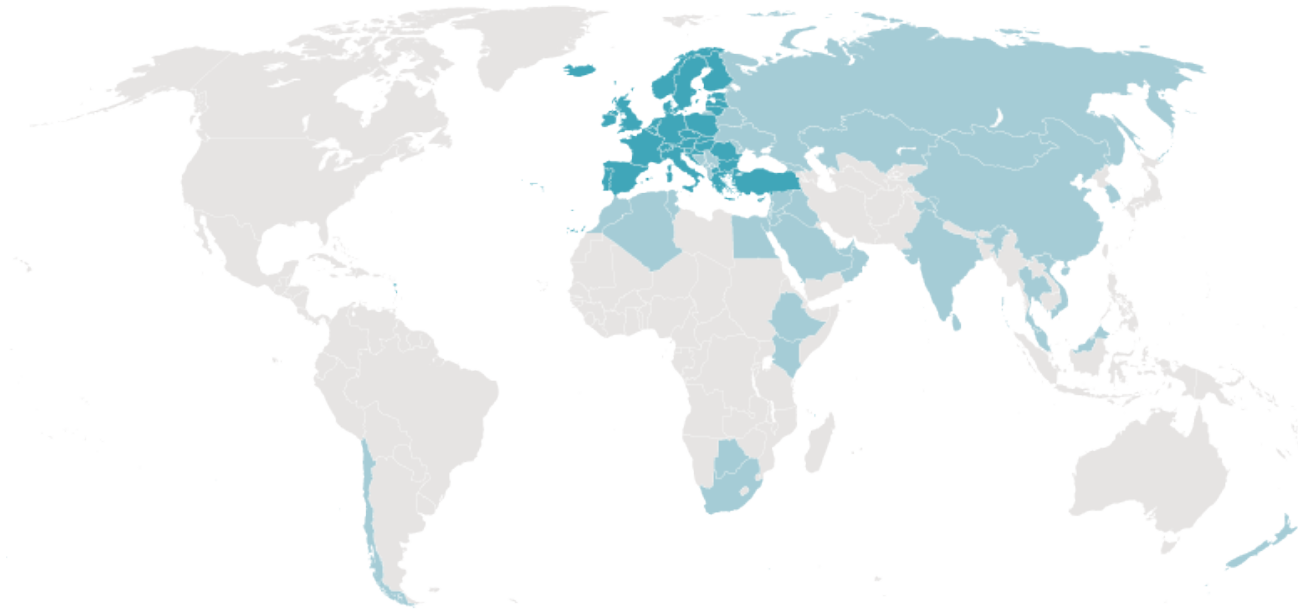

NOTE: European Committee for Standardization (CEN) is a technical organization composed of the National Standards Bodies of 33 European countries.

SOURCE: Eurocodes; McKinsey Global Institute analysis

Another incipient trend that may spread and help to promote productivity is the acceptance of foreign building standards by a country where a construction project is taking place. One example was the \$4 billion Ethiopia-Djibouti railway, constructed in accordance with China's level-two electrified railway standards in their entirety—both technology and equipment. The government of Ethiopia investigated how Chinese and Western standards of construction compared, and concluded that Chinese standards were equal to Western ones in terms of delivering an effective project but were better suited to local conditions.

Appeals processes remain a concern. There are good reasons for environmental or other appeals. But they are sometimes misused by citizens or companies to block or delay projects that conflict with their interests; in California, for instance, appeals citing the California Environmental Quality Act have acted as a significant barrier to affordable housing development.⁴⁹ Special appeals panels that accelerate decisions and increasing transparency on who is filing appeals can help.

⁴⁹ *A tool kit to close California's housing gap: 3.5 million homes by 2025*, McKinsey Global Institute, October 2016.

INCENTIVIZE PRODUCTIVITY BEST PRACTICES USING NEW, FORWARD-THINKING REGULATION

Policy makers should actively consider productivity outcomes when they draft new legislation in three areas in particular: improving the sector's innovation; developing a stable, high-skilled workforce; and facilitating large-scale development.

Improve the rate of innovation and its use

Regulators should consider how best to stimulate innovation. In some countries, encouragement of innovation takes the form of direct government funding for R&D, the externalities of which bring benefit to the economy as a whole. For example, since 1990 Germany's Federal Ministry of Transport, Building and Urban Development (renamed the Federal Ministry of Transport and Digital Infrastructure in 2013) has sponsored research for technical studies to improve building materials, lower building costs, and make projects more environmentally friendly.

Governments can also help to ensure that the results of the R&D are implemented effectively by mandating their use on public-procurement projects. They can also provide tax credits or reduce fees for private-sector players and projects that use these practices. Belgium uses fiscal policy to encourage scale and repeatability for productive practices. From 2017, the Flemish government will award grants from a €10 million fund to citizens to renovate their homes, contingent on homeowners installing energy-efficient fixtures and finding at least ten other local homeowners to do the same. This drives more energy-efficient communities, homeowners being supported to improve their homes, and contractors being able to undertake renovations at scale and in a repeatable fashion, thus driving productivity.

Policy makers should consider developing a dedicated organization to review and approve innovative methods and materials. One example of such an organization is Singapore's Building Innovation Panel, whose task is to facilitate rapid evaluation and approval of innovative construction products and methods. Since its inception in 2011, Singapore's construction productivity has increased by at least 20 percent.⁵⁰

Develop a stable, high-skilled workforce

The productivity growth of an organization is highly dependent on whether it has a stable, well-trained workforce capable of mastering and implementing best practices. Policy makers can support the development of skills.

Cyclical in the industry is a major barrier to stable employment, and governments around the world should consider ways of overcoming this hurdle. Singapore has introduced a SkillsFuture program that enables workers of all ages across sectors to boost their skills consistently throughout their careers, using accumulated credits in a "skill account." In Europe, some governments pay a portion of the salary of workers during downturns to avoid at least some of the layoffs that would otherwise occur. During the economic downturn in 2008, European countries weathered the crisis better than their US counterparts, with unemployment in the Eurozone increasing by 30 percent compared with 100 percent in the United States, and real incomes in some European countries, like Sweden, continuing to rise.

Licensure, training, and certification are also important aspects of developing a competent workforce. Governments can provide rebates to companies for on-the-job training, expand public trade and vocational educational options, and move toward a graduated licensure system in which experience and level of certification increase in parallel rather than a binary licensing system that increases barriers to competition.

⁵⁰ Singapore Building and Construction Authority press release.

Facilitate large-scale construction

Complex ownership structures and land fragmentation, often occurring for historical reasons, are significant barriers to scale. Where possible, land should be “assembled” from individual parcels into a single site (see Box 6, “Alternative methods of land assembly”). This requires strong stakeholder management and business or value evaluation skills from regulators and developers, alongside supporting legal tools like compulsory purchase orders where needed.

ENCOURAGE TRANSPARENCY AND COMBAT INFORMALITY

One of the biggest challenges facing inexperienced owners looking to build complex projects is the gap that exists between what they know about the cost of a project and what their contractors know. There are several drives to make the construction industry more transparent, and these will help clarify the costs of projects and make performance management and holding to account easier. An example of this is the International Construction Measurement Standards coalition.

While a large part of improving the productivity of the construction industry falls to owners, contractors, and suppliers, governments can do a lot to incentivize and support improvement. As countries manage to achieve the required high level of health and safety performance standards that have resulted in a sharp reduction in the number of accidents on-site, regulation should become more streamlined and targeted at developing the productivity of the industry.

Governments can also consider and implement controls on informal labor. Singapore has moved to limit the use of inexpensive migrant labor, introducing a manpower levy on foreign workers that has progressively increased to the current levels of \$600 to \$2,000 per worker. Measures of this type encourage firms to invest in domestic talent and technology rather than relying on cheap migrant labor.

Box 6. Alternative methods of land assembly

In Japan, public or private development authorities readjust existing lots to develop infrastructure according to a plan that requires approval by a majority of landowners. Developers sell a portion of the assembled land to cover costs and return the remainder of the land to landowners, who benefit from appreciating values after development. The use of this approach increased rapidly after the Kanto earthquake in 1923 and the devastation of World War II, and helped Japan rapidly and efficiently to rebuild. Nearly 30 percent of urban land in Japan was developed with this method.¹

In Gujarat, India, the authorities have adopted a two-stage land pooling and readjustment program. First, they create an overall development plan focused on areas of urban growth and infrastructure expansion. They then put the plan into action in increments of one to two square kilometers across pooled land with the installation of roads, public amenities, utilities, and social spaces. The land value of the entire district increases significantly, providing adequate compensation for owners' willingness to participate. In the ten years ending in 2009, this approach enabled the productive development of 700 hectares and primary infrastructure assets including a major city ring road.²

¹ Hirohide Konami, “Japanese efforts to supply low cost housing,” presented at 42nd East Asia Regional Organization for Planning and Housing Regional Conference in Ulaanbaatar, Mongolia, September 24, 2009.

² Shirley Ballaney, *The town planning mechanism in Gujarat, India*, World Bank Institute, 2008.

2. REWIRE THE CONTRACTUAL FRAMEWORK

Construction projects come with built-in tension between owners, who desire the lowest cost and shortest schedule, and contractors, who want to maximize their profit. Such conflict may inhibit communication and cooperation, resulting in claims and variations that bust budgets and deadlines, and compromise productivity.

In MGI's Construction Productivity Survey, respondents identified misaligned contractual structures as one of the top two causes of low productivity. The biggest contractual problems cited were the suspicion and distrust engendered by the competitive bidding process, the failure to adequately incorporate project uncertainties into contracts, and ineffective risk sharing among all stakeholders, including subcontractors. A lack of transparency and trust among the various entities on the job site also inhibits improvements in productivity, but rarely do owners offer incentives for contractors to collaborate.

Moreover, owners tend to choose a contractor based on either its strong market reputation or the lowest bid price, without any due diligence beyond company financials. Little importance is given to contractors' capabilities, performance, and differentiating qualities. A recent McKinsey analysis of large investment projects found 80 percent average cost overruns in the sector due to change orders. The analysis found that all the parties involved in projects had contributed to change orders, the implication being that all actors need to foster improved and deeper collaboration.⁵¹ Project owners, designers, contractors, subcontractors, and suppliers all need to play their part in fostering improved and deeper collaboration that would help to increase the stability and predictability of the process (see Box 7, "Expert panel: Digby Christian and James Pease, Sutter Health").

THE INDUSTRY NEEDS TO RECONSIDER HOW PROJECTS ARE SET UP TO DRIVE COLLABORATION

We highlight three aspects of improving collaboration on projects. Moving forward on all three will require a significant transformation in attitudes, culture, and contractual obligations among participants in capital projects.

Improve how projects are tendered and contractors appointed

The tendering process needs to reflect comprehensive due diligence and a thorough negotiation with prospective contractors based on a detailed project risk assessment:

- **Perform thorough contractor due diligence that goes beyond project cost.** Owners can benefit by thoroughly evaluating prospective contractors on critical non-cost factors such as their past performance, competence, risk exposure, project-management systems and other IT tools, and compliance with health, safety, and environmental regulations. This due diligence should involve building a fact base and set an absolute baseline that all bidders must pass to take on the project.
- **Follow a systematic risk-based contracting approach.** Project risks should be identified and prioritized by their potential impact and probability of occurrence. Owners should promote a risk-based contract structure in which each key project risk is assigned to its "natural owner." For example, project owners are typically the natural risk owners for scope changes and site conditions. Detailed impact assessment of critical risks also enables owners to design compensation structures and negotiate effectively.

⁵¹ *Imagining construction's digital future*, McKinsey & Company, June 2016.

- **Assemble a multidisciplinary negotiation team.** An effective negotiation strategy should aim to maximize project economic value over the overall life cycle of the project. Private companies capture value through aggressive one-on-one negotiations with suppliers. Owners should bring together a competent, multidisciplinary team to develop a structured negotiation plan with clear outcomes.
- **Establish multiround best-value public-sector tendering.** Public-sector and state-owned companies usually apply a one-round bidding process to minimize the risk of perceived and real corruption, but this tends to leave a lot of value on the table. We recommend two-round bidding to increase the number of bidders and the technical and economic competitiveness of the offers. McKinsey's experience suggests that public-sector companies could save 7 to 15 percent of the overall contract cost by allowing bidders to adjust their commercial offers based on economic feedback. This process is transparent and has minimum risk if the economic assessment is handled under strict confidentiality standards. Moreover, public tendering often strictly favors lowest-cost offers. Some entities such as Infrastructure Ontario have moved to a best-value approach that places higher emphasis on the quality and past performance of suppliers.

Box 7. Expert panel: Digby Christian and James Pease, Sutter Health

Sutter Health, a not-for-profit health system with more than 5,000 physicians, 50,000 employees, 24 acute-care hospitals, and dozens of outpatient surgery and specialty centers, serves over 100 communities in Northern California. In 2000 it set out to replace and upgrade its hospitals in response to state-mandated seismic requirements via a \$7 billion capital program.

Early projects with similar goals had been beset by late delivery and significant budget overruns. Furthermore, independent studies by entities such as the Construction Industry Institute confirmed Sutter's experience: 70 percent of capital projects were delivered over budget or late or both.

This significant lack of predictability in capital projects is very hard to deal with as an enterprise. Put starkly in the context of current concerns about labor productivity, in 2000 Sutter Health would gladly have chosen predictable low-productivity projects over unpredictable high-productivity projects.

So Sutter Health focused on improving reliability. From the start, the network engaged with its community of designers, constructors, and consultants to request their input on how to address the risk Sutter Health faced from its capital program.

This engagement came up with five big ideas:

- Optimize the whole project, not the parts
- Manage projects as a network of commitments
- Collaborate—*really* collaborate
- Tightly couple learning with action
- Increase relatedness

These ideas were the foundation of a new delivery model for Sutter Health that launched in 2004. It began with assembling integrated teams of designers, consultants, and builders, and used them from project concept to opening and activation. Sutter Health put the companies in the integrated team collectively, rather than individually, at risk under a new contract form known as the Integrated Form of Agreement. In this new environment, the big five ideas flourished.

Since 2004, under this new delivery model, Sutter Health has completed more than \$1.5 billion of capital work as requested—on schedule and on budget. An additional \$3 billion is under construction using the same principles.

Where is Sutter Health headed next? Lean thinking holds that it is not possible to continually improve an unstable process: stability comes first, continuous improvement second. Sutter Health has stabilized its delivery of capital projects and is only now consciously and deliberately embarking on the continuous improvement phase—to the benefit of millions of patients and the larger Northern California community.

Ensure that a collaborative culture is fostered outside the contractual framework

To enable success in any type of contractual arrangement, it is essential to establish a collaborative and trusting environment for all parties. This can be achieved through early definition and alignment on a project's scope, improved management of the process, and increased transparency through the life of the project:

- **“Overinvest” in up-front planning and scoping.** Teams should align on and fix the specifications of a project as early as possible. One of the largest sources of delays and overruns is changes in specification by the owner even after work has started on-site. One solution is to dedicate time and resources to front-end loading the process—developing the scope of the project, splitting the project into manageable work packages, assessing the market for contractors and suppliers, and preparing a contract strategy before the project is submitted to the chief executive or board of directors for approval. In his book on industrial megaprojects, Edward Merrow demonstrated that megaprojects with the highest level of front-end loading were 62 percent less likely to have cost overruns and schedule slips of less than 25 percent, compared with 9 percent in the case of those with poor levels of front-end loading.⁵²
- **Make project integration and interface management priorities.** The fragmented nature of the construction industry means that every project engages many subcontractors, irrespective of its size or complexity. Coordinating and integrating these parties is a considerable managerial challenge and one that is often not met. Owners should ensure that they have teams with sufficient capacity and the required technical capabilities to manage this integration, even if they have appointed third-party consultants to perform this role.
- **Set up a “single source of truth.”** A key foundation of effective collaboration is ensuring that everyone is working from the same basis—that there is one agreed version of the truth in project drawings, schedules, KPIs, and so on. Achieving this will require investment in modern digital-collaboration platforms and solutions, in addition to well-structured and fact-based project-performance reviews.
- **Learn from experience and each other.** Bringing contractors into the process and making space for a blank-sheet approach creates an opportunity to discuss possible changes in scope, how to standardize designs, and which innovative technologies could be used. Through such dialogue, contractors can air potential upsides and risks of different techniques, enabling owners to make an informed decision that is not solely based on minimizing risk. Each stakeholder can draw on its experience of what works or almost worked, and how things could be done differently; each can broaden its knowledge and expertise while creating a platform for working collaboratively in the future.

⁵² Edward W. Merrow, *Industrial megaprojects: Concepts, strategies, and practices for success*, Wiley, 2011.

Structure the contract to best support collaboration

The construction industry has traditionally been conservative and resistant to new ideas, and this applies to the contracting structures used. A recent McKinsey analysis found that more than 50 percent of megaprojects around the world have used a “lump-sum turnkey engineering, procurement, and construction (E+PC)” contract. Owners should look to add incentive programs to traditional contracts or use more sophisticated contracts to avoid today’s often hostile contracting environment:

- Add incentive programs to traditional contracts.** This is a way to align the interests of the owner and contractors, and it can motivate contractors and their teams on-site. Incentives are most effective if designed in cooperation with contractors and are attractive enough to ensure that the contractor has a stake in improving the project’s outcome. It is important that the arrangement is self-funding and that any additional profits and savings are shared with contractors. However, care needs to be taken to ensure that incentive plans are not abused and do not lead to unintended consequences. For example, an incentive to complete a project on time should not encourage shortcuts that can adversely affect quality. In addition, incentives should focus on building a “system” for delivering pieces of work rather than enhancing the productivity of individual workers, machines, or contractors. A contractor completing its assigned tasks may be rewarded, but this would not be desirable if that contractor has held back the progress of others and therefore the final deliverable. Incentivizing progress toward milestones of a functioning system encourages continuous communication and awareness among all of those involved in a project.
- Institutionalize collaboration through alternative contracting strategies.** The construction sector, especially in developed economies, is increasingly adopting several alternative contracting strategies that promote higher levels of collaboration and risk sharing among involved parties (Exhibit 36 and Box 8, “A brief overview of common alternative contracting models”). In such arrangements, a project is viewed as a collective enterprise, and joint decision making is encouraged.

Exhibit 36

Collaboration and risk in contracting strategies lie along a spectrum

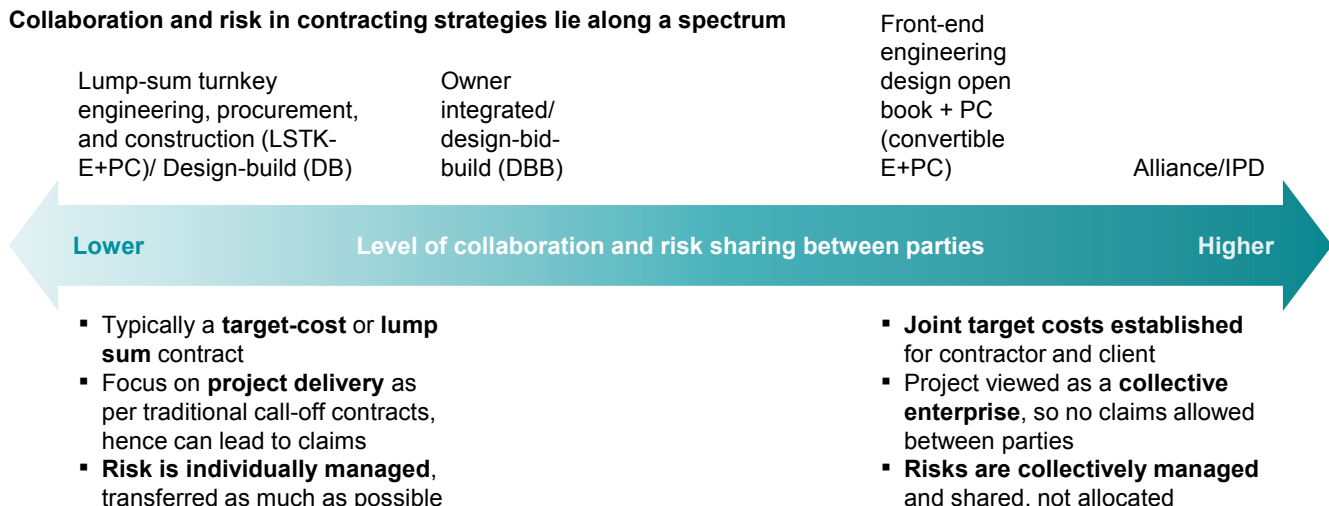

SOURCE: McKinsey Global Institute analysis

The IPD contracting model and integrated forms of agreement are slowly gaining traction in the construction industry, as an antidote to the blame-and-sue culture that inhibits productivity. Interviews with experts suggest that IPD has been successful in large construction projects such as hospitals, hotels, and data centers, and that there is scope to apply this approach to roads, highways, bridges, and small- to midscale power plants. Successful delivery of an IPD model requires an owner to have a portfolio of projects to enable knowledge transfer and development among projects, to be in a strong financial position to make large up-front investments for each project phase, and to be proactive in driving productivity improvements such as lean construction. A contractor needs to be willing to put profit at risk and engage in an open-book approach, focus on long-term multipartnership, and be fully committed to the principles of lean construction.

IPD is not suitable for all projects. In the case of projects that have standardized scope and design where cost and schedules are highly predictable, it is easier for owners and contractors to agree on reasonably accurate bids, and a traditional contract with efficient project management can suffice. Conversely, IPD may not work well in projects where the scope is highly uncertain (for example, a project involving subsurface conditions in a tunnel excavation); the high level of investment required up front may be put at risk by trying to apply an IPD model. Finally, IPD may not be suitable for one-off projects with unique designs, such as a stadium where the owner may be less experienced at managing large capital projects; again, a traditional contractual model that makes it possible to outsource technical capabilities may serve better.

Box 8. A brief overview of common alternative contracting models

During the front-end engineering design (FEED) process, the owner and contractor develop the scope of the project, baseline schedule, and cost together. The contractor discloses its expectations for overhead and margin through design and construction. The second phase is then tendered for a lump sum, and the FEED contractor can throw its hat into the ring. This approach provides a higher degree of certainty on price, schedule, and quality, but it requires the owner to have sufficient technical capabilities to challenge the FEED contractor during the scoping phase.

IPD contractually binds the entire project team to work in collaboration through the life of the project, facilitating joint decision making through consensus in the hope of maximizing the value of the project for all parties. An IPD agreement incorporates jointly defined “conditions of satisfaction” and KPIs to benchmark the speed, cost, and quality of the work. The success of each team member is tied to the success of the entire team.

Alliances and partnerships are other ways to bring together the many contributors to a project, enhancing collaboration and improving communication. Alliances are agreements in which companies pledge to collaborate closely on a project but remain independent businesses. In a partnership, two or more contractors on the same project create a separate, jointly owned company to oversee construction and share the profit (or loss). Either model can radically change the incentive structure to encourage a very high level of collaboration and risk sharing among all parties involved, for example through no-claim, no-blame, or no-dispute clauses in the contract.

3. RETHINK DESIGN AND ENGINEERING PROCESSES

Due to large variations in project specifications, designs often become very specialized, which makes it difficult for contractors and suppliers to work efficiently and results in lower productivity. The process of design needs to be streamlined and made more collaborative, and the repeatability of designs encouraged in order to drive scale in the production of elements used in construction projects. Designing early has the greatest potential to influence the eventual cost of a project. Reducing overdesign, improving coordination, removing ambiguity, and creating a cost-efficient constructible design that maximizes the amount of components that can be produced off-site will have a significant impact on the rest of the construction process (see Box 9, “Expert panel: David Scott, Laing O’Rourke”). Capital expenditure on materials, typically 50 percent of the total construction cost, will be lower; the number of errors will fall; and reducing the number of elements that are installed will speed up construction. Fully implementing best-practice design and engineering processes can deliver large productivity improvements and is key to any move to a mass-production manufacturing-style production system (see Chapter 4 for a full discussion).

THE INDUSTRY NEEDS TO IMPROVE DESIGN PROCESSES AND OUTCOMES THROUGH GREATER COLLABORATION

Design is currently a relatively non-collaborative process. In large construction projects, owners typically contract with a firm to create a concept or front-end design that is then handed to contractors to further detail. The latter have little say on the initial design, and this can result in on-site complexities and constructability issues being solved late in the process rather than at the outset. To resolve this problem, either designers must be knowledgeable about construction techniques or the contractor must have input during the design stage in order to avoid the difficulties caused by a separation between the design and construction stages of the process. Unexpected delays will otherwise be more likely, incurring far greater cost.

Owners need to take responsibility for executing and managing a process that maximizes the opportunity for high-quality design and simultaneously enables higher construction productivity. This should be ensured through creating initial design briefs and tender documents that are clear, putting a structure in place for numbering reports and drawings and scheduling future technical and constructability reviews. In the case of large owners, maintaining a database of prequalified contractors with a track record of experience and effectiveness can be a useful shortcut in the tendering process, which can be combined with an invitation to market leaders in a particular area to submit an expression of interest. When approached by contractors to which an owner has not previously been exposed, that owner needs to undertake meticulous due diligence with clear criteria for prequalification that will generate confidence that the winning contractors can deliver a project on schedule and on budget.

Box 9. Expert panel: David Scott, Laing O'Rourke

Productivity increases with repetition and with certainty. When people know what they are doing and how long it will take, they are able to continually improve. When they are also able to benchmark their work against very similar projects, they have confidence and certainty that they can deliver successfully.

In New York City, for instance—as in most of the United States—it is normal practice to complete 100 percent of the design of residential and office buildings prior to contract. New York buildings tend to be simple, repetitive, and tall, and the industry has developed specialists in design, development, and construction that are pushing efficiency. These specialists have established long-term relationships with one another, and all parties are clear about performance, expectations, and deliverables. They have a single point of ownership in design and construction. Unfortunately, this does not mean that New York is highly productive as construction is also governed by local work practices and their approach to off-site manufacture.

Where buildings are more complex, as they tend to be in London, a different approach is needed. In the UK capital, sites are unusually shaped because of ancient street plans and a subway system that continues to evolve, and this often combines with a desire to do something different in terms of architecture and engineering. Designing a unique or unusual building means that experience cannot be brought to bear, that there is limited knowledge, and that there is often no clear basis for costing and programming, which is only partly compensated for by digital engineering. Developers often want to test costs early and then transfer design and inappropriate design risk to the builder.

Standardization and pre-assembly offer further opportunities to improve productivity and move construction off-site into a manufacturing environment. Like Hong Kong, London, and New York, Singapore suffers from a reliance on low-skilled imported labor to support the construction industry. In response, the government of Singapore has mandated that all new bathroom construction be modular and has provided support to establish an accreditation system for new manufacturers. This has not only improved productivity but also introduced Singaporeans to the opportunities, variability, and massive potential of modular construction. There is an opportunity for other cities like London to follow suit, as there are few variations in bathrooms that are needed to comply with the London Housing Design Guide, and are an ideal component of prefabrication.

Technology will also be a major part of how we solve the chronic underproductivity in the construction sector. Tools are already coming on line that help us build with increasing confidence and certainty. We expect to see the following key changes:

- **Modeling:** BIM will transition from simple digital models to a single integrated digital environment that provides the source of all project information to all parties.
- **Planning:** We will develop the “Google Maps” of the construction process that recognizes that there are an infinite number of ways to build things, but that will help the construction teams and planners select the most efficient way; and will find “alternative routes” to react to day-to-day changes.
- **Prefabrication and standardization:** Buildings will generally include more and more prefabricated components and will embrace the variability and precision of manufactured components. Tools will enable parametric remodeling of buildings to enable the automatic incorporation of factory-made products into construction projects.

There will be massive improvements in the productivity in the construction industry in the next ten years, and cities, countries, and companies that facilitate these improvements proactively are those that will benefit the most.

The scope of the project should be unambiguous and comprehensive, with clearly identified design items for the contractor. Detailed RASCI (responsible, accountable, supporting, consulted, informed) matrixes can be used to ensure that there is no misunderstanding of responsibilities for particular aspects of the project.⁵³ Because the design phase is often rushed, contractors either know that plans will change because the design is not final or that the project will be delayed so that the design can be finalized. A high-quality, coordinated design is likely to be achieved only if there is a realistic schedule in place. By allowing enough time for the design function, the process can avoid overdesign, time lost to requests for information, claims, and owner-instigated charges, thereby reducing the overall cost of the project and the time it takes to complete.

Once the tender is out and the owner has received comments from contractors, and clarifications and alternative proposals have been received, it then needs to review these, update documents accordingly, and reissue them as contract documents. Where possible, submission via BIM should be encouraged so that each contractor bid can be integrated into the full project design. In the United States, the General Services Administration mandated in 2006 that new buildings designed through its Public Buildings Service use BIM and open-standard facility management data for all project milestones. In Singapore, the Building and Construction Authority has put in place the world's first BIM electronic submission system.

At the beginning of the design process, focus on design management incorporates life-cycle cost-benefit tradeoffs and therefore optimizes the overall cost of a project. Sometimes this can result in a design that is imperfect in engineering terms but achieves higher productivity; by imperfect design, we mean one that exceeds specification in some respects, such as load bearing, but that leads to higher constructability (see Box 10, "Simplified design improves productivity"). An alternative minimum technical solution method considers design in a different way. Instead of starting with a pre-existing design and making changes to improve constructability and life-cycle costs, this approach encourages the creation of a design that is as simple as possible while meeting minimum requirements set by the owner. Priority is given to any design additions taking into account their costs and benefits, and then used to develop a final design.

At each stage of the design process, the owner's requirements and conceptual design choices should be challenged, but in a way that doesn't compromise required functionality and compliance with the owner's brief. Value engineering is typically applied to the design of a component such as a bathroom unit in a residential development. Using a hypothesis-driven approach, each part of the design is examined and challenged to see whether it can be achieved in a better way while limiting its costs. The potential cost benefits of the changes are then reviewed and prioritized.

⁵³ RASCI, which is also called RAM or RACI, is a management tool used to clarify roles and responsibilities in cross-functional projects. RASCI is a way of describing the responsibility of a particular stakeholder for a task.

Box 10. Simplified design improves productivity

As an illustration of the dangers of overoptimized design, consider the drawing of the planned foundations of an airport to the left in the illustration below (Exhibit 37). This original design contained one-directional strip footings with intricate waterproofing details at each footing location. Although this solution met the design brief, it was anticipated that the complexity would reduce productivity when it was built. Therefore, a second design (to the right) was suggested that vastly simplified the waterproofing details. A single layer was placed between the footings and the ground, which was not only much easier to construct but also made the footings less susceptible to future damage from changes in the contact between the soil and the concrete. The switch to a simpler design saved \$10 million in capital expenditure on the project and compressed the project schedule by four weeks.

Exhibit 37

Reducing complexity and improving constructability of foundations reduced capital expenditure and accelerated construction schedule

Original foundations design

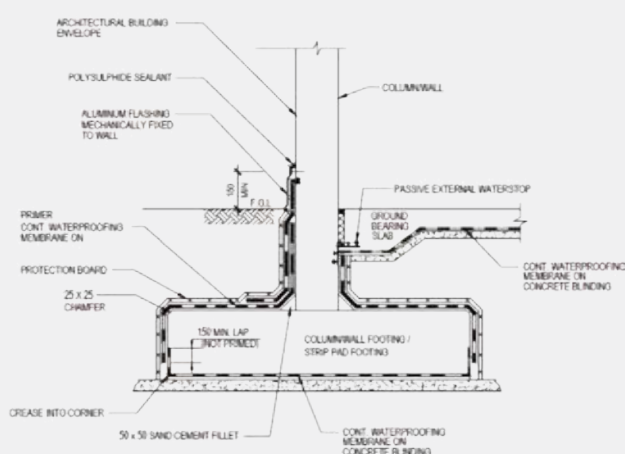

Adopted foundations design (site instruction)

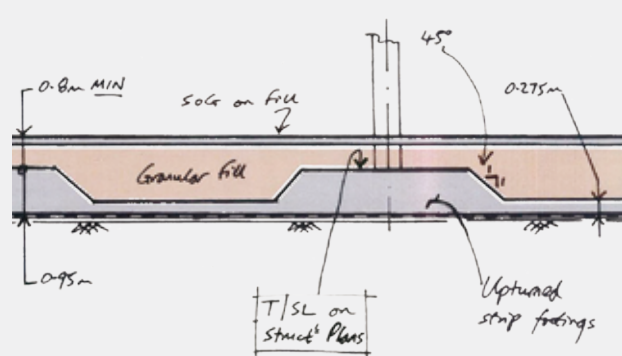

SOURCE: Project director; McKinsey Global Institute analysis

IMPROVED DESIGN CAN CREATE OPPORTUNITIES TO INCREASE SCALE AND PRODUCE EFFICIENCIES THROUGH REPEATABLE ELEMENTS

By looking for opportunities to use common components and prefabricated parts earlier in the process, cost-saving materials can be used more often. Real estate is one area that offers an opportunity to increase scale because of the repeatable nature of the projects. This is particularly true for large-scale affordable housing programs. For example, residential apartment blocks tend to have a high number of common components, from bathroom fittings to entire apartment units. Large civil infrastructure projects also offer an opportunity to standardize because they tend to have lower complexity, particularly in elements such as road barriers and dividers, overpasses in non-urban areas, and utility culverts. There is also an opportunity in industrial projects, although in this case the potential is more dependent on their size and sophistication. Smaller industrial projects can use shared design almost in their entirety (see “Production system case study: Outotec” in Chapter 4). However, large megaprojects, which are customized to some degree, can take advantage of common units and the replication of certain elements with the rest of the design formulated around the modules. This process is called site adaptation. Some players in the oil and gas segments have begun using repeatable designs as a new way of working (see Box 11, “ExxonMobil utilizes design-one, build-multiple strategy”).

Box 11. ExxonMobil utilizes design-one, build-multiple strategy

ExxonMobil delivered a large-scale deepwater project on four sites off the coast of Angola using a strategy called “design one, build multiple” that uses repeatable designs. For Kizomba B, one of the four sites, the repeated design reduced the transition time from design to construction and the construction phase itself, and the project was delivered five months ahead of schedule. The facility built was not optimized for the site, but the cost and schedule savings far outweighed the cost of “overdesign.” Procurement was simplified, with 260 of the 273 vendors the same on Kizomba B as on previous projects. Elements of the project were prefabricated in Angola, Malaysia, the Netherlands, South Korea, and the United States, and then assembled on-site.

The impact of the repeated design was significant. All four sites were benchmark projects that set world-record cycle times with the lowest unit development costs for projects of this size and complexity. Experts estimate that cost was reduced by over 10 percent. The repeated design also increased contractor productivity by 25 percent during hull construction.¹

¹ L. B. Waters, P. P. Smith, and C. A. Prescott, “Leveraging lessons learned across multiple deepwater projects,” presented at the Offshore Technology Conference in Houston, Texas, May 1–4, 2006.

The construction industry can also harness “off-siting” techniques such as the prefabrication of elements and modules off-site, which can proportionally reduce the typical delays experienced on-site. For example, oil and gas projects are located where these resources are extracted, and these locations often offer less than ideal conditions for construction work. Undertaking the majority of the work in a controlled factory environment before assembly on-site reduces complexity and increases quality and productivity. This approach was used by Bechtel in its Curtis Island project and by ExxonMobil in its offshore deepwater Kizomba project.

4. IMPROVE PROCUREMENT AND SUPPLY-CHAIN MANAGEMENT

Effective procurement and supply-chain management are compromised by the fragmentation of the construction industry. Poor performance on both is responsible for a significant share of all time and cost overruns in the industry, compromising productivity. Surveys conducted by McKinsey’s Procurement Practice indicate that construction is one of the least sophisticated sectors in procurement and supply-chain practices. Companies can overpay by up to 15 percent for materials and services, while poor supply-chain management typically accounts for 10 to 30 percent of cost and time overruns. Ensuring that materials and services are delivered on time reduces waste, scheduling difficulties, and change orders, and maximizes resource utilization, all driving higher productivity. We see three imperatives:

USE STANDARD PROCUREMENT TOOLS FROM OTHER INDUSTRIES AND INCREASE TRANSPARENCY

Contractors should seek ways to improve value in procurement. Specifically, they can improve value through purchasing tools such as best-cost country sourcing; technical optimization, such as standardization of specifications; and process optimization, such as payment terms. It should not only identify the impact of these levers, but also assess the challenges and risks of pursuing such approaches. For each category of materials supplied, the contractor needs to develop a clear perspective on the drivers of total cost of ownership—that is, the purchase price, logistics, efficiency, maintenance requirements, and so on. The contractor should also develop clean-sheet cost models for those categories

where there are significant additional costs to the material purchase price, including transportation and storage. Using scorecards that measure cost and status relative to the original plan, combined with tools to challenge and validate change-order requirements, can help with performance management. Katerra is an example of how improved value can be achieved through procurement (see Box 12, “Case study: Katerra”).

Managing subcontractors is one of the most challenging aspects of procurement. Various suppliers offer very different packages, such as transportation and assembly of materials, assembly only, or commissioning, and this makes central procurement more complex. Robust clean sheeting, in which subcontractors detail exactly what their customer is paying for, including price per crew member per hour, price of materials, and so on, is the most effective way to obtain good value; it enables informed negotiations with subcontractors. Contractors can validate costs either through comparison to previous projects or by developing “should cost” models. The next step is to put in place an overall master plan that details the required timing for major components, their interdependencies, important milestones, and risks associated with each of them.

In terms of suppliers, managing supply chains is compromised by a lack of communication—and therefore a lack of investment and trust—between supplier and contractor. All too often, a supplier will not inform the contractor that a delivery is likely to be delayed, arguably because the supplier has little involvement in the planning process and has an exclusively transactional relationship with the contractor. Unlike other sectors such as automotive and aerospace where vendor development is a long-term strategic lever, there is no incentive for the supplier to deliver better service levels than originally specified. One solution is for constructors to issue a six-week look ahead (see the next section for more on this) to suppliers to give them transparency that enables them to plan transportation terms. However, only 44 percent of companies surveyed currently do this. Transparency can be reinforced by contractors embedding agents on the construction site to raise any concerns.

On many projects, there is little management of materials during the delivery phase and once they are on-site. Too often, there is no tracking of inventory and no system that organizes where materials should go, which have been used, and how soon they are likely to be out of stock—all of which could be solved by daily record keeping. Overall, there is a fundamental challenge facing the management of the construction supply chain—the fact that traditional materials are bulky, heavy, and non-standardized, and often require fabrication and finishing on-site. Concrete, for instance, has to be mixed and transported from a supplier nearby in a specially designed vehicle rather than cast off-site and brought on-site through regular delivery routes. Standardizing components and modularizing design also help to build flexibility into the transportation of materials to site. Currently, the logistics for materials and components is decided case by case, with different shapes and sizes of transportation needed for each delivery. With standardization, transportation methods could be common for all deliveries, giving flexibility on routes and rerouting, the driver, and the load being carried, as well as achieving scale benefits from procuring a single specification of vehicle.

Box 12. Case study: Katerra

Katerra, which recently raised \$75 million in a first round of funding, is a Silicon Valley startup that focuses on using innovation and leveraging insights from data in all stages of the construction process. The company manages vertically integrated end-to-end supply chains for product sourcing and building materials with the aim of reducing project timelines and costs. It sources materials globally and has strict standards for suppliers. By serving and sourcing globally, the company is able to aggregate demand to obtain better rates as well as

optimize its logistics network, providing just-in-time inventory management and on-time delivery. Additionally, Katerra has its own manufacturing facilities, where it uses technology to help avoid production disruptions due to weather, market conditions, and labor issues that commonly cause problems elsewhere. Although still early in its life, there is much excitement within the industry around the potential of Katerra to use its insights and global footprint to create a more compelling proposition than its non-digital competitors.

INVEST IN A CENTRAL PROCUREMENT, SUPPLY-CHAIN, AND LOGISTICS ORGANIZATION

Construction firms and their suppliers frequently look at each project separately, often due to bespoke customer requirements, and miss opportunities to secure economies of scale in procurement. A global supplier could batch together materials destined for projects in the same geography, raising efficiency and lowering logistics costs. A large construction firm could procure materials for several projects in its portfolio at the same time and accurately forecast base demand for a year using annual targets and historical numbers, but this is quite rare in the sector. Developing expertise and learning lessons is easier for firms with a central procurement team, which is able to inform the project team of what worked previously in that geography or on that specific type of project. It is common practice in the oil and gas industry to send scouts to a new market in order to get to know local practices, customs, and suppliers. This helps a company to make a realistic assessment of any risks to the schedule and informs planning. Not understanding customs processes, for instance, can cause significant delays that could be avoided by knowing which documents are required and ensuring that customs officials are ready to receive and process materials.

Many engineering firms are setting up central procurement offices. These typically face two challenges. First, there is a significant asymmetry of information between people in central procurement and those working on-site. This can lead to separate packages being ordered and a disconnection between the person who decides on quantity and specification and the person who actually does the purchasing. Moreover, the central procurement team tends to focus on obtaining the lowest purchase price, irrespective of lead time or total cost of material to the point of delivery. The answer to this issue is improved communication channels and more focus on robust clean-sheeting approaches in which costs are validated by comparing the cost of previous projects, for instance. Second, construction projects are on a tight schedule, and therefore there is a tendency to work directly with suppliers on-site to ensure that materials or equipment arrive on time rather than coordinating with the central procurement team. This issue can be resolved through increased focus on planning to ensure that last-minute changes are not required and through procurement designating a person on each site whose job is to sit between both worlds and help to improve communication and coordination.

Managing a supply chain well and thereby reducing costs, reducing inventory rotation days, and performing to schedule requires an integrated approach. Effective planning and close engagement with the client up front and through tendering, with constant monitoring of progress against that plan to ensure that adjustments can be made when issues arise, are crucial building blocks.

LEVERAGE NEW DIGITAL TECHNOLOGY TO BUILD MORE SOPHISTICATED PROCUREMENT SYSTEMS

Teams now have an opportunity to digitize their entire procurement workflow, using relevant data on cost structures, supply availability, lead times, financial and operational risks, and service and quality metrics to position themselves to negotiate the best prices achievable. There are two categories of digital applications that will make a significant difference to a firm's procurement performance: tools that identify and create value, and tools that prevent the leakage of value. Tools in the first category include those that create visibility on spending by using historical data on invoices, material-cost indexes, and other benchmarks to identify opportunities in sourcing. The second category involves improving tools such as “procure-to-pay” by using vast quantities of order and invoice data to create predictive order configurations and to automatically identify potential suppliers for categories not covered by contracts or catalogs. Such approaches enable firms to track receipts and goods automatically, eliminating the need for invoice matching.

Advanced analytics can further be used to identify non-compliance in both transaction-intensive purchases and large, high-value outsourced contracts where contract conditions can be extracted through machine reading and compared with continuous streams of invoices, supplier activity, and performance data. This depth and breadth of data will create formidable performance management capabilities both within firms and with suppliers, driving far greater productivity improvements than those that are achievable from conventional improvements in procurement.

Data-driven analytics should be used to review and update best practices. Using 6D BIM—5D BIM plus a supply-chain dimension—can ensure seamless interfaces and coordination throughout the construction process. Once the model is created, the contractor should be responsible for overall coordination in addition to updating the model as the project progresses. Suppliers can continuously update the delivery schedule, which means that the contractor has visibility on where things are in the network and if any delays are expected. In addition, 6D BIM can integrate data on, for instance, the exact position of trucks in a delivery network to ensure that the information is there for clear decision making. To support this process, the right trade-offs between optimizing the frequency of transport of materials and the cost of inventory to the whole firm must be made at the outset. Agile operations are needed to detect issues and respond to uncertainty, and all performance-management systems need to have both top-level KPIs and detailed process data. For markets in which a player operates regularly, arranging weekly or monthly deliveries of essential materials and equipment can help ensure that projects aren't held up by a lack of the basics; this also costs much less than arranging the first shipment ad hoc, just before the project begins.

Other digital technologies, including the Internet of Things and advanced automation, are playing an ever more important role in managing supply chains. The Internet of Things enables efficient tracking of inventory levels and automatic, predictive replenishment from suppliers. Products can be shipped before a construction firm even places an order, and a shipment already in the network can be rerouted to the required destination. Timing of deliveries can respond to external factors such as weather conditions and market trends in order to optimize both the price and the time of delivery—all while remaining on the critical path schedule. These technologies enable suppliers to be more flexible and more adaptable to real-time changes in demand, as well as being open to developing a network where vehicles can change their destination if required to respond to reordered delivery priorities. Digital clean-sheet models for warehousing, transportation, and inventory should be used to set targets automatically and adjust when necessary. Performance management systems can in future be programmed to “learn” to identify risks or exceptions and adapt to mitigate them in a closed-loop learning approach, slowly minimizing human involvement except in the case of large, unforeseen shocks.

A large breakthrough in the way procurement is carried out has been the increasing use of e-auctions using web-based online platforms. They enable real-time interaction with suppliers and create a transparent and efficient way of conducting negotiations while ensuring confidentiality. The many advantages of e-auctions over traditional procurement can produce savings in the range of 10 to 20 percent. An e-auction is a one-time event in which all suppliers can see the prices their rivals are offering, heightening competition. Traditionally, an opaque bidding process gave no incentive to reduce a bid to undercut a rival, because a contractor would not know the value of a competitor's bid. Intensifying competition further, offers are made simultaneously in a limited time frame, increasing the pressure to respond quickly in order to win. Because the process is quick, it is cheaper in process terms.

5. IMPROVE ON-SITE EXECUTION

Despite the construction industry's desire and commitment to improve the way it executes projects on-site, the productivity-improvement curves contained in this report suggest that the industry has thus far failed to do so. Executing construction projects is a major managerial challenge. Projects may have numerous subcontractors and hundreds of workers on-site who have never worked together before. While engineering and construction firms try to deploy sophisticated management programs, the reality is that despite these systems, the industry struggles to deliver projects on budget and on time. Current efforts to improve on-site execution too often rely on historical rather than modern thinking (see Box 13, "Expert panel: Todd Zabelle, Strategic Project Solutions").

The current approach to managing work on-site results in unnecessary cost, use of cash flow, schedule duration, risk of safety incidents, and often quality and operability issues. Owners routinely cancel projects because they are not economically feasible, while contractors undertake excessive risk for the potential return on investment they seek. Most troubling about this dynamic is that it diminishes the ability to control time-to-market effectively and optimize revenue. These failings are critical for energy, manufacturing, and processing companies that rely on assets to produce their products and solutions.

The result of this is that the industry is losing significant loss of value for shareholders and society in general. It is testament to the seriousness and persistence of current failings in on-site execution that most owners and their contractors regard these failings as "normalized pain"; some have even set up business models predicated upon living off the waste in the system.

Why has this situation been allowed to persist? Managing work on-site is a complex and dynamic challenge often left to superintendents and foremen who may not have the necessary education, training, and tools to do their jobs effectively. Compounding the problem is the belief among many managers that workers do not want to work efficiently, leading to the adoption of approaches that often result in unintended consequences. These approaches include amassing large inbound material stocks, the application of Critical Path Method (CPM) scheduling to manage execution of work, and the desire to move work to offsite fabrication and assembly shops. Contracting models that intend to mitigate and/or shift risk also contribute to conflicting incentives that result in unnecessary cost and schedule overruns, which superintendents and foremen are expected to resolve. While some of these measures have treated symptoms of the problem, they have been ineffective at addressing the true root causes.

Box 13. Expert panel: Todd Zabelle, Strategic Project Solutions

Delivering capital projects effectively remains an elusive aspiration. Unnecessary cost and time is incurred; capital is tied up. Effective management of sources of variability and work-in-progress can reduce the cash locked up in a project by 50 percent.

To understand where we are, we must acknowledge how we got here. For the most part, the present-day approach to delivering projects has not progressed much since the introduction of Frederick Taylor's scientific management at the beginning of the 20th century to the advent of formal project management.¹ Taylor based his work on the premise that workers will aim to ensure they earn more money and gain longer-term employment by working slower. Shortly thereafter, Daniel Hauer applied scientific management to construction.² Taylor's introduction of functional roles, time-and-motion studies, and application of the bar chart (the contribution of Henry Gantt) are all still in wide use today. In the 1950s, faced with the inability effectively to predict cost and completion dates for mission-critical defense projects, the US Department of Defense set out the basis of modern-day project management, introducing methods such as Program Evaluation and Review Technique and later Earned Value Analysis. DuPont and Remington Rand Univac introduced CPM scheduling during the same era.³

Modern-day project management is essentially based on the work of Taylor, Hauer, and the US Defense Department. The construction industry has overemphasized functional processes and underinvested in understanding and managing work, both knowledge and craft. Yet other industries have achieved continuous and simultaneous improvement in productivity, quality, and cost efficiency. What is different? Although many believe the one-off nature of projects is the issue, close examination indicates that something else is occurring.

The best way to understand that "something else" is to look through the lens of operations sciences, a well-established engineering field that has had little—if any—influence on the construction industry. Perhaps the most fundamental principle that relates to capital projects is the relationship between throughput (the amount of work being produced for a given time), work-in-process (inventory), cycle-time, capacity utilization, and variability.

Variability is present in all production systems, including projects. This can result from detrimental causes, such as a late delivery, or from beneficial causes, such as a design change that creates a better asset. Regardless of whether the cause is detrimental or beneficial, variability will always increase the duration of the schedule, the need for capacity (labor, equipment, and space), or some combination thereof. Owners and contractors intuitively recognize the negative impact of variability, but rather than mitigate the sources of variability, most use inventory as a buffer against its impact. However, amassing, handling, holding, and preserving inventory, along with the potential for damage, theft, and obsolescence, also increase the need for capacity. This strategy results in unintended consequences including a further increase variability during the project-delivery process.

This creates a vicious cycle that directly impacts project performance unless detrimental variability is reduced—and this is only achieved through effective project-production management.

¹ Frederick Winslow Taylor, *The principles of scientific management*, Harper & Brothers, 1911.

² Daniel J. Hauer, *Modern management applied to construction*, McGraw-Hill, 1918.

³ Willis H. Thomas, *The basics of project evaluation and lessons learned*, second edition, CRC Press, August 22, 2014.

A new framework is needed—in essence, a project-operating system that takes into account the fact that project systems are both technical and social, and oriented around managing variability and flow efficiency. Critical elements of the next-generation capital-operating system are technical, managerial, and behavioral elements that are interconnected and linked (Exhibit 38):

Exhibit 38

A new project “operating system” is needed to achieve a step change in predictability, productivity, and performance

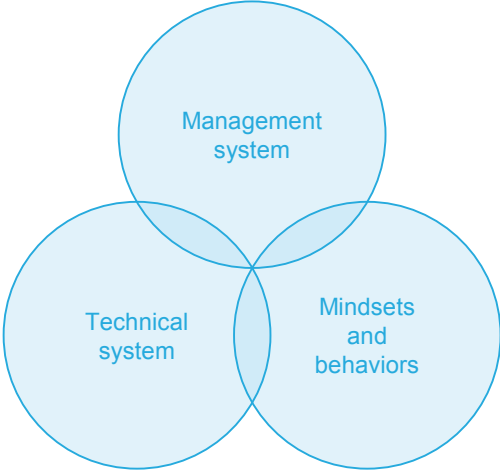
- Comprehensive KPIs in place to track project outcomes and planning efficacy (e.g., Percent Plan Complete [PPC]). Strong focus on variability, plan conformance, and inventory
 - Contracting strategy aligning commercial interests of all stakeholders to overall project success (relational vs. transactional, IPD)
 - Cloud-based data hub (control tower) to manage performance
-
- Treat performance as you treat safety: Everyone should understand the project operating system
 - Cross-contractor control tower war rooms used to ensure rigorous problem solving, visual management, and performance dialogues
 - Project production system in place with “gold-standard” project controls and a project production-management system (e.g., LPS)
 - Employ technological innovation as practicable, but not as a panacea (e.g., automated work packaging, 5D BIM, and big-data analysis to predict productivity, cost, and schedule)
-
- 
- The diagram consists of three overlapping circles arranged in a triangle. The top circle is labeled 'Management system'. The bottom-left circle is labeled 'Technical system'. The bottom-right circle is labeled 'Mindsets and behaviors'. All three circles overlap in a central region.
- Stakeholders embrace roles as part of an integrated project team
 - Capability-building programs for the next generation of project managers, foremen, and craft workers (use train-the-trainer on-site)
 - Root-cause analysis in place that focuses on improving, rather than pointing the finger of blame

SOURCE: McKinsey Global Institute analysis

Such an operating system is analogous to those that have been used in manufacturing for decades to great success. Although we acknowledge that managing a very large capital project on-site can be more challenging than overseeing a fully automated manufacturing plant, adopting and adapting principles and systems from other industries including large-scale manufacturing will prove beneficial.

Specifically, construction will benefit from adopting a production-system perspective in which work processes are more defined and standardized, material inventories are optimized and better controlled, and labor is more effectively allocated. However, doing so requires a shift in thinking about how to approach management of work on the construction site, as well as an effective framework for understanding throughput, variability, inventory, and capacity.

As variability increases, so does the level of inventory on a project or the need for capacity or some combination of both. Owners and contractors intuitively understand this relationship, and seek to put buffers in place against variability. Since formal project management does

not recognize variability and inventory, they tend to use inventory as their preferred buffer—that is until the scheduled completion date becomes at-risk, and then the strategy shifts to increasing capacity by adding labor and equipment. A better option would be to identify sources of variability and mitigate them as far as possible while at the same time buffering those sources that should be reduced (beneficial variability) and those that cannot be reduced using a combination of capacity and inventory.

Project-production control addresses variability by applying an integrated set of business processes, rules, and measurements that enable superintendents and foremen effectively to design, integrate, and coordinate work processes, including ensuring that predecessor tasks are complete and that existing capacity is used efficiently. This not only reduces variability and associated work-in-progress within site assembly and commissioning, but also establishes a robust and reliable basis for synchronizing the flow of supplies with on-site demand. However, variability in the supply flow needs to be addressed before synchronization is possible. Through value-stream optimization, the overall cycle time (including drivers such as process time, move time, batch time, setup time, and queue time) can be optimized and variability within the supply flow minimized. These two components—project-production control and value-stream optimization—enable synchronization between supply flows, and assembly and commissioning flows, reducing work-in-progress throughout the process.

The result is a highly robust and predictably performing project production system, but how can owners and contractors begin the migration to this end state? As a starting point on the journey to a truly integrated operating system, we suggest four ways to improve on-site execution, none of which are new but all of which should be implemented universally on building sites, with owners and contractors prioritizing different aspects (see Box 14, “Owners and contractors should prioritize different aspects of improving on-site execution”):

Box 14. Owners and contractors should prioritize different aspects of improving on-site execution

Owners and contractors share the responsibility of improving on-site execution, and the two need to collaborate.

- **Integrated planning.** Owners should own the overall master plan with the key milestones that need to be hit. The contractor is responsible for producing the integrated plan and associated detailed plans and schedules, and for demonstrating how these key milestones will be achieved. Owners should also engage at the look-ahead planning level to understand upcoming challenges and engage in problem solving. This differs from traditional command-and-control mechanisms often used to plan and manage work on-site. Engaging the workforce in look-ahead planning uncovers untapped productivity potential.
- **Performance management.** Owners and contractors need to work together closely to agree on and monitor KPIs. These KPIs should include both look-back (safety, schedule, cost, and quality) and look-ahead metrics incorporated in the LPS such as PPC, Tasks Made Ready (TMR), Tasks Anticipated (TA), and Pareto analysis of planning failures. Owners and contractors need common KPIs to establish a collaborative environment and maintain it throughout the project to ensure that they can work together effectively to monitor performance and respond to issues as they arise.
- **Mobilization.** Owners should own and drive the mobilization plan supported by the contractor. Both parties need to resist pressure to start on-site before all activities in the mobilization phase are completed.
- **Waste and variability.** Establishing collaboration on this front is the responsibility of owners and contractors; contractors also need to work closely with subcontractors to identify ways to reduce waste on-site. The only way to accomplish this objective is by applying production control as a missing element in current capital-operating systems. Only then can waste and variability be managed systematically.

INTEGRATE PLANNING AND SCHEDULING

Reliable plans are a prerequisite for effective execution on any site. Projects break down because planners do not take into account uncertainties such as bad weather and realities such as holidays, customs clearances, and difficult logistics. Too often, plans do not have sufficient detail to enable owners to steer activities on-site effectively, and supervisors have to rely on past experience and intuition. Best practices indicate that approximately 25 percent of the cost of a project should be spent on planning.

A basic fix is deploying the LPS to create integrated plans that cascade from a master plan down to weekly and daily schedules (see Box 15, “Expert panel: Glenn Ballard, Project Production Systems Laboratory, University of California, Berkeley”).

Box 15. Expert panel: Glenn Ballard, Project Production Systems Laboratory, University of California, Berkeley

It is generally accepted that planning and preparation improve performance. Less known is what encourages planning and preparation. LPS improves workflow reliability and in turn encourages investment in planning and preparation. The measure of workflow reliability is PPC where tasks are fully completed or no credit is given. If foreman B follows foreman A (for example, an electrician follows a pipe fitter), and A has a PPC of 50 percent, B is less likely to invest in preparing to execute a task that may not be available.

How much impact can planning and preparation have on productivity? Plotting the weekly productivity of multiple pipe fitter crews against their weekly PPC reveals a positive and statistically significant correlation (Exhibit 39). Productivity can be forecast by substituting values for PPC in the equation of the line drawn through the graph. A PPC of 50 percent corresponds to productivity 4 percent better than budget, and a PPC of 80 percent corresponds to productivity 29 percent better than budget.¹ Since productivity budgets are set based on historical unit rates, it is evident that the projects of this pipe fitter contractor have operated at a PPC near 50 percent.

Even more important than its power to improve productivity, LPS stabilizes work flow, which makes investment in further improvement economically viable. We looked at the weekly and cumulative performance factor (PF, or actual productivity as a percentage of budgeted) of construction crews on a Venezuelan refinery project (Exhibit 40).² Over a period of approximately eight weeks, the PF deteriorated to 1.5, meaning that 50 percent more labor hours were being expended than budgeted for the work completed. “Began screening assignments” refers to the LPS principle of including on weekly work plans only tasks that are defined, sound, sequenced, and sized to the capabilities of their performers—the attributes that will most likely lead to successful task execution. Biweekly variation in PF was drastically reduced, and the rising trend in cumulative PF was reversed.

¹ Min Liu, Glenn Ballard, and William Ibbs, “Work flow variation and labor productivity: Case study,” *Journal of Management in Engineering*, volume 27, issue 4, October 2011.

² Glenn Ballard et al., *PARC: A case study*, Proceedings of the Fourth Annual Conference of the International Group for Lean Construction (IGLC-4), Birmingham, United Kingdom, 1997.

Exhibit 39

On-site PPC is strongly correlated with the weekly productivity of pipe fitters

Weekly productivity for working areas A-E and G

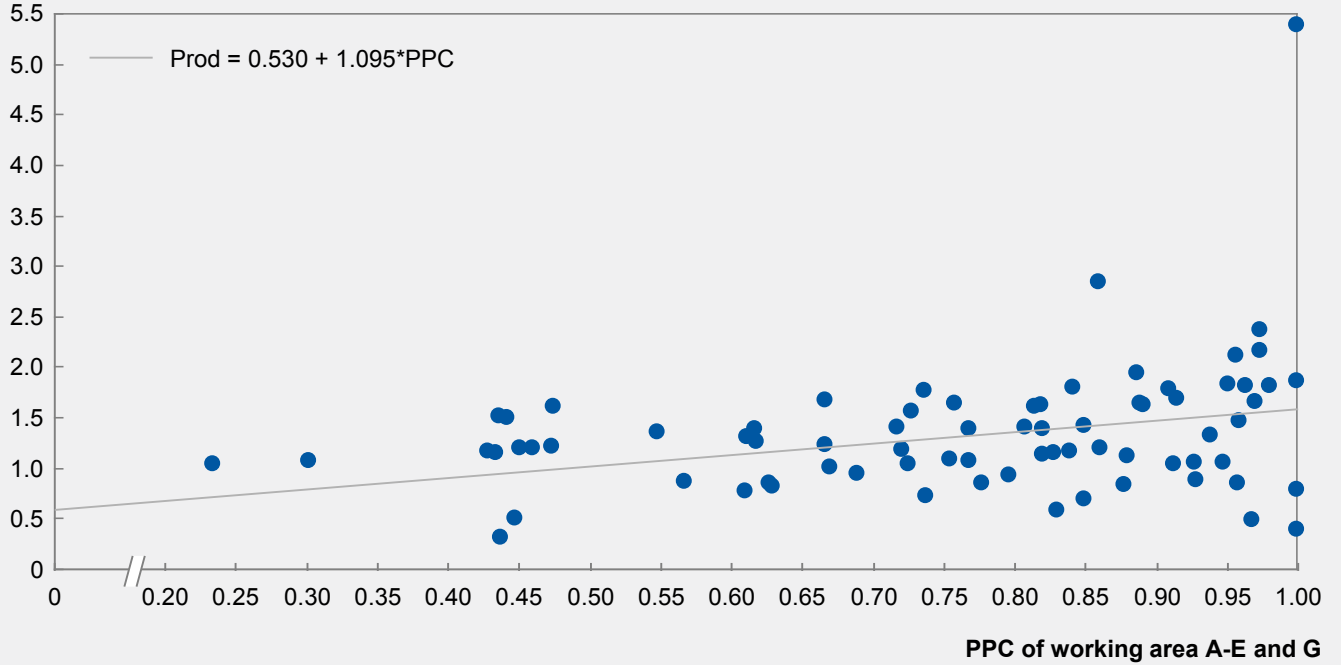

SOURCE: Min Liu, Glenn Ballard, and William Ibbs, "Work flow variation and its relation to labor productivity—A case study," *Journal of Management in Engineering*, 2010; ASCE; McKinsey Global Institute analysis

Exhibit 40

The performance of a refinery project improved once LPS was implemented

Performance factor

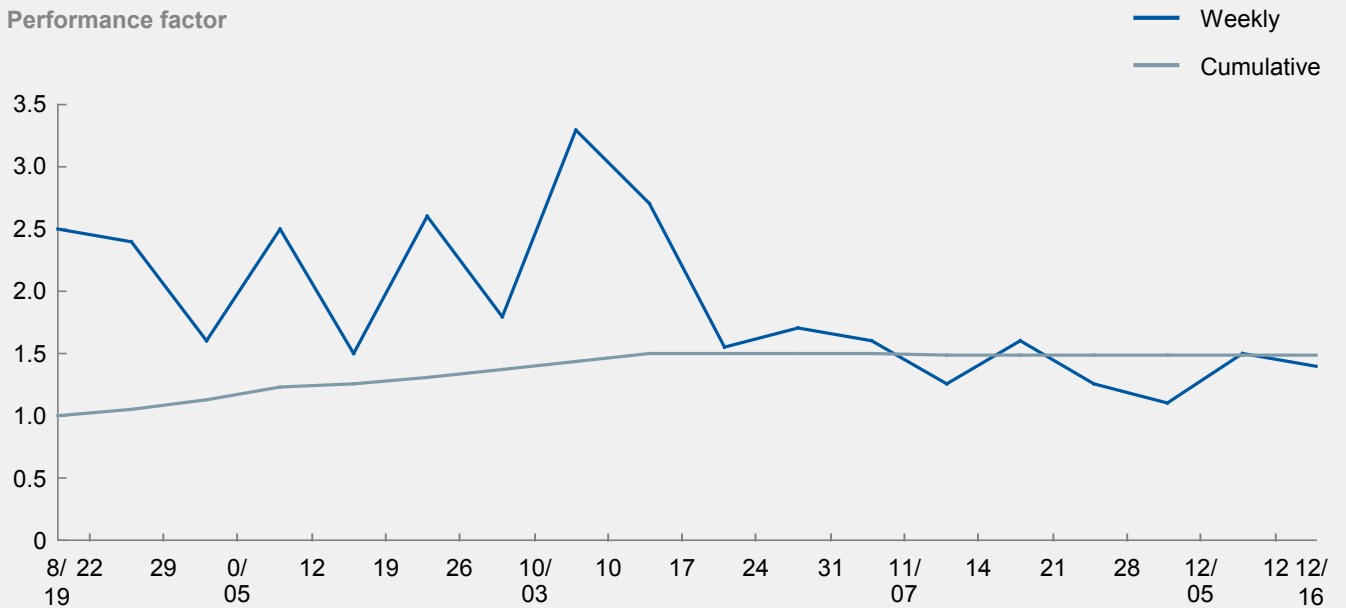

SOURCE: Min Liu, Glenn Ballard, and William Ibbs, "Work flow variation and its relation to labor productivity—A case study," *Journal of Management in Engineering*, 2010; ASCE; McKinsey Global Institute analysis

The LPS is built up of four levels:

- **Master plan.** This should include key managerial and contractual milestones that provide the overall context to the project. This should not be a 2,000- or 3,000-line planning tool, but should focus on the key facts and leave the details to the other levels of the LPS. The owner and contractor need to align on this plan.
- **Pull planning.** This is a visual tool used to plan the activities from the key milestones in the master plan. The tool is populated by working back from the final milestone on the project, detailing the key activities that need to be completed by discipline to show which player is responsible for them, what resources and suppliers are required, and the key interfaces.
- **Six-week look ahead.** This takes the activities for the next six weeks from the pull planning for each person responsible for a part of the project. It enables analysis of progress during the week and whether the schedule was adhered to. It also enables project participants to look ahead six weeks to ensure that their planning for all labor, equipment, materials, and activities is being executed fully and on time. Weekly meetings are set up to review the six-week look ahead and align on outstanding issues.
- **Daily scheduling.** These daily schedules are populated from the six-week look ahead and issued to each crew leader who then runs check-ins and check-outs with the team to identify the key activities to be completed each day, what was not completed the previous day, and how to ensure that the team catches up.

McKinsey's experience suggests that PPC, which is a measure of completion of a specific task planned for each day, is a highly effective tool, when complemented by the full suite of LPS metrics including TMR, TA, and Pareto analysis. PPC not only considers whether a certain amount of dirt was moved on a particular day but measures whether the specific amount of dirt in the plan to be moved that day was actually moved. Although marginally more difficult to measure, this gives a more accurate reflection of progress. In addition, by creating an issues/actions log and tracking whether required action is being taken, the firm can assess whether production constraints are overcome efficiently, and can intervene if required. Sites should strive to ensure that they hit a 90 to 100 percent PPC (see Box 16, "Lean Construction Institute case studies on the boost to productivity from using integrated planning").

Box 16. Lean Construction Institute case studies on the boost to productivity from using integrated planning

Prior to using an integrated planning and scheduling approach on the construction of a medium-sized (around \$800 million) hydroelectric plant in Latin America, the project was significantly behind schedule with a PPC of below 50 percent. This means that less than half of the tasks expected to be completed by that point had been.

The first remedial step was to implement LPS to create exhaustive and achievable work plans. The increased planning transparency boosted the project's PPC from 40 to 90 percent for critical milestones. Then the owner analyzed the productivity of two key repetitive activities: tunnel construction and dam-material consolidation. By applying lean optimization and performance management tools, the owner achieved a sustained 15 to 20 percent reduction in the time spent on the first, and a 45 percent productivity improvement on the second. In addition,

this exercise identified three other critical risks that could potentially have caused 20 days of delay and created an extra \$5 million in cost.

Prior to using an integrated planning and scheduling approach, one oil and gas megaproject was significantly behind schedule where PPC was below 50 percent. In other words, the actual number of tasks completed was only half of what it should have been. Productivity was also low, fluctuating between 60 and 80 percent. In order to boost productivity, LPS was implemented. Two months later, PPC had increased to 85 percent, meaning that the project had bridged the gap between actual and planned tasks and had made up some lost time. This resulted in a 140 percent productivity improvement over the level prior to implementation of integrated planning.

IMPROVE PERFORMANCE MANAGEMENT

There are three key components to performance management on a construction project: identifying KPIs, coordinating and aligning with stakeholders, and tying together physical and economic progress on-site.

KPIs should be defined for each of the disciplines on-site. They need to cover safety, schedule, cost, and quality, and should be in addition to the look-ahead planning metrics that we have described. These indicators are maintained in a control tower, a central location where they can be clearly monitored. Visibility on outcomes in a timely manner and with an appropriate level of detail enables the frontline “plan-do-check-act” process that is inherent to continuous improvement. Each discipline has a weekly meeting at which all engineers and supervisors discuss what the KPIs showed, what is going well, and where change is needed. The KPIs should be comprehensive and clear enough for the company CEO to review them and understand the performance of the project (see Box 17, “Expert panel: Keith Dodson and Richard Westney, Westney Consulting Group”).

Alignment with key stakeholders begins at the outset of the project with the initial agreement on milestones, both final and intermediate. This alignment is necessary not only for physical progress on-site but also for financial progress. The client needs to understand the key constraints on contractors and subcontractors and their role and responsibilities for resolving them, including licenses and permits. Weekly performance meetings should be set up that include the client and contractors to monitor progress and resolve issues as they arise in a collaborative way. In the case of disputes, third parties should be brought in to measure physical progress.

Our survey found that contractors currently use standard productivity norms and measure productivity regularly but that owners do not. This makes it difficult for the latter to have an accurate view of on-site performance and to hold contractors to account.

Box 17. Expert panel: Keith Dodson and Richard Westney, Westney Consulting Group

Those managing construction projects today have to deal with copious amounts of data from Primavera P6 schedules with 30,000 or more lines to a large volume of metrics and KPIs in monthly reports. As project leaders diligently try to investigate this extreme detail, they often lose their focus on production rates—such as linear feet of pipe installed per week—that determine the schedule and productivity.

This loss of focus on production rates tends to kick in as soon as the first detailed project schedule is built. Schedulers, who normally have limited experience with physical construction, use the detail accommodated in the scheduling tool to build thousands of individual activities, each with a duration that reflects a certain degree of optimism. In isolation, all these activities look achievable but once they are rolled-up produce an unachievable outcome. On one project, there was a large disparity between what a contractor's P6 schedule (gray line) produced, and what, when pressed, the contractor said was a reasonable and sustainable rate of piping production (blue line) (Exhibit 41). The difference between the original schedule and what could be achieved delayed the completion of the project by four months.

There can be a similar loss of focus on production rates in engineering. Engineering plans are often optimistic because they are based on engineering production metrics such as the number of isometric drawings produced per week, which cannot be achieved. The unrealistic engineering schedule that results leads to unsustainable construction starts, or crews mobilized with insufficient engineering completed to work efficiently, leading to lower productivity for the project.

Moreover, construction packages are being defined earlier and in greater detail through, for instance, advanced work packages, which limit the flexibility of frontline construction leaders, and causes them to lose sight of the rates required and, ultimately, accountability to deliver those rates. Building these detailed construction packages effectively, especially on megaprojects, requires experienced construction people to sit in the engineering office for weeks, working in front of a computer and providing input into package development. Often, the most knowledgeable people are unavailable or unwilling to spend sufficient time on such tasks.

Our view is not that detail is bad, or that planning isn't worthwhile, but that these cannot be done without consideration of what can physically be achieved, nor in a way that dilutes accountability. We therefore recommend that three aspects should be considered in order to better leverage the potential of today's tools and take into account the reality of what can be achieved:

- Understand the production rates required for engineering and construction, test for achievability, and incorporate them into, and track them as part of, the project plan
- Require contractors to demonstrate how they can achieve the rates required before selection (for example, sufficient, tenured craft/trade leadership)
- Hold engineering and construction frontline leaders accountable to meet the rates, and let them make the final decisions on how to achieve them.

Exhibit 41

Comparison of weekly piping production plans

Pipe installed per week

Million linear feet

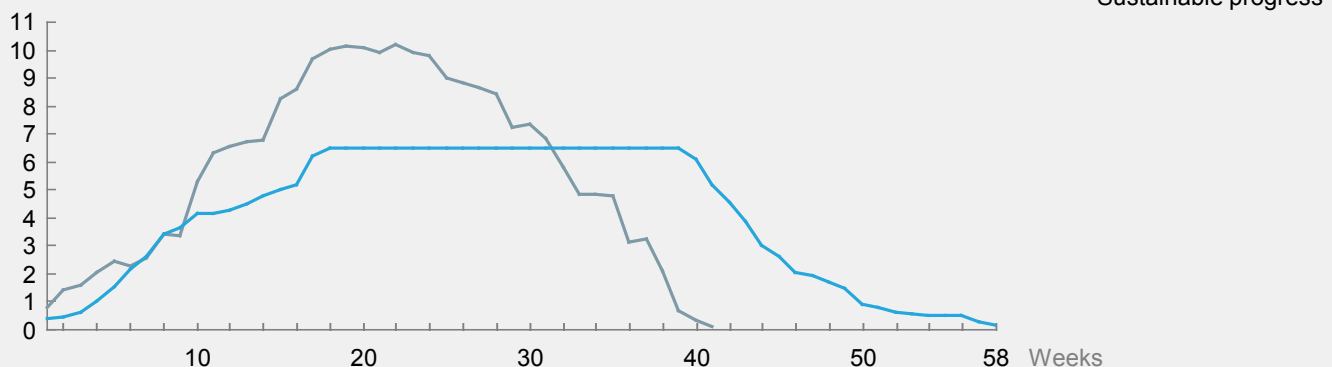

SOURCE: Westney Consulting Group; McKinsey Global Institute analysis

BE MORE EFFECTIVE IN MOBILIZING PROJECTS

All construction projects, and especially megaprojects, can be compared with startups. Both involve a large number of people who have never worked together before, with their own tools, culture, and norms that act as barriers to mobilization and effective working.

Three key aspects need to be mobilized on a project: personnel, materials, and equipment. Standardized processes will reduce cost, increase transparency for all participants, and minimize idle time, thereby boosting productivity across these three aspects. The processes should have clear accountability and be linked to the integrated project plan to identify all activities that need to be completed before mobilization can start. Once a project begins to be mobilized, firms should operate using lean principles in order to track what are often very complex projects with many silos where decisions are hard to reverse once people have been brought on-site. To avoid delays, project participants should ensure that all regulatory processes are completed, including obtaining the right permits, securing authority to build, meeting any local requirements, and satisfying local health and safety regulations.

Project-support tools can facilitate the mobilization process, but often parties use different tools. It is imperative that these are standardized across the project to avoid confusion and multiple versions of the truth.

In addition to the KPIs we have discussed, more formal arrangements such as service-level agreements can be put in place with service providers to ensure that remedial action is taken as soon as problems arise.⁵⁴ All stakeholders should also ensure that the workforce is effectively onboarded and receives the necessary training to use all tools effectively.

As much consideration should be given to demobilization as to mobilization. All construction projects have an end date that needs to be planned for, and a site that was peopled by thousands of people can have only a handful of people working within a matter of two weeks. More broadly, construction firms would benefit from developing a “playbook” of common processes, tools, and metrics for launching and winding down any new project. This would create a common language between owners and contractors that would allow for the most efficient ramp-up possible.

⁵⁴ A service-level agreement is an output-based agreement on the level of service expected from a provider that is defined by the customer.

REDUCE WASTE AND VARIABILITY

The productivity of activities on-site can be improved by minimizing variability and waste. Only by reducing and actively managing drivers of variability can workflow be optimized and cycle times reduced. Standardizing ways of working is one way to reduce variability since each stakeholder understands how a process should be carried out and what the expected outcome is. The focus should be ensuring “first time right” execution to minimize rework.

Project-production control systems, integrated with 5D BIM, are emerging in the market to help address the challenges of waste and variability. This is a welcome innovation and will help teams manage their projects better and move beyond exclusive focus on backward-looking project controls. These systems help teams tackle waste and variability in the three key phases of design, planning, and execution. In the design phase, it is important to fully understand the challenges and working conditions to be clear about how the assembly will work, and particularly how the different trades and disciplines will coordinate. During planning, it is crucial to ensure that, as they are being developed, pull planning and six-week look aheads take into account the possible interference and conflicts between the different disciplines and the domino effects of delays by one team on the full program.

Project-production control provides the necessary integrated set of business processes, including associated rules and measurements, along with the supporting tools to enable frontline supervisors to plan and control the execution of work effectively, and thereby eliminate sources of waste. This approach includes cross-discipline process design (effective integration of work execution), allocation of capacity, and management of variability including its sources.

Collection of data from frontline supervisors indicates that a lack of information and materials is not the problem, but rather the inability of superintendents and foremen to manage execution of work effectively at the point of installation. This is symptomatic of inadequate use of lean management of the construction process. Our survey found that lean processes and tools were the least-used best practices in project management, with only 38 percent of respondents saying that they had used them (Exhibit 42). Like the other parts of effective on-site execution, the elimination of waste requires buy-in from and collaboration between all the stakeholders. Many of the best ideas for eliminating waste come from frontline workers. To capture these insights, periodic workshops should be held to discuss ways to improve efficiency of processes and reduce waste during construction.

While eliminating waste is an important focus for heavy construction, waste is also an issue in the small fragmented trades segment of the market. Reducing waste and variability is one way that small fragmented trade can increase productivity and move toward the more productive parts of the industry.

Exhibit 42

Mandating of lean processes and tools was the least-implemented best practice of project management

Recommended best practices—level of adoption among firms

Strongly disagree Disagree Agree Strongly agree Low High

Best practice	Level of adoption				Average score		
	%				Build- ing	Civil	Indus- trial
We have standardized project startup and closure checklists and are able to staff a dedicated project manager and team from start to finish and ensure all contractual deliverables are met	3	22	47	29	2.83	3.05	2.71
We involve all functional experts (e.g., sourcing, engineering, and estimation team) to come to an accurate estimate of time and cost; we involve external experts in areas we need a second opinion	1	18	56	24	3.22	2.98	2.70
Our project team sequences tasks to minimize waste and maximize project flow	2	16	60	22	3.06	3.02	2.70
We proactively manage permits and approvals to ensure smooth site activities; we invest in liaising with relevant stakeholders to ensure zero interruptions to site work	4	9	67	21	2.56	2.71	2.54
We use analytical tools for contracting and procurement (e.g., clean sheet costing, low-cost country sourcing, productivity benchmarks)	4	37	39	20	2.56	2.62	2.41
Resource and equipment usage is planned to optimize critical path delivery to proactively reduce restrictions and delays	1	18	62	20	2.89	2.87	2.65
We use industry standard planning tools and are effectively able to translate masterplans into the daily activity schedules for foremen and crews	6	23	53	19	2.94	2.73	2.47
We effectively forecast labor needs throughout the project lifecycle	4	24	57	16	2.83	2.87	2.54
Projects synchronize pre-assembly with final assembly to minimize transport, handling and space requirements; pre-assembly items are grouped into kits and delivered to site to optimize flow	4	31	52	13	2.61	2.51	2.26
We devote enough time and attention to a proper site survey at the earliest stages, often deploying two independent teams for very large projects in order to triangulate estimates and conclusions	8	40	41	10	2.72	2.40	2.19
We utilize proactive initiatives for identifying and reducing sources of rework, resulting in rework	10	43	38	8	2.67	2.44	2.16
Supply deliveries for projects are based on real sequence of tasks in coordination with the warehouse to trigger just-in-time delivery of materials and minimize space requirements	6	36	50	8	2.83	2.54	2.27
We apply structured problem solving based on lean techniques, including both root-cause removal and short-term crisis management	6	43	44	8	2.61	2.44	2.25
Lean processes and tools are used and mandated throughout the project lifecycle	11	51	31	7	2.56	2.35	2.06

NOTE: Numbers may not sum due to rounding.

SOURCE: MGI Construction Productivity Survey; McKinsey Global Institute analysis

USE DIGITIZATION AND TECHNOLOGY TO ENABLE IMPROVED ON-SITE EXECUTION

The four approaches discussed are not reliant on technology, but the technological advances that we examine in the next section can help to increase productivity improvements. As mentioned, traditional control towers can be enhanced with project-production control and 5D BIM to seamlessly integrate drawing, scheduling, and budgeting and to provide owners and contractors with a clearer fact base to enhance decision making and performance tracking. Internet of Things sensors can increase the amount of data collected on resource performance. Advanced analytics can be applied to these data to further enhance decision making, identify and eliminate waste, and potentially help to predict where bottlenecks and other issues are likely to occur. Increased automation, including, for instance, use of automated bricklaying machines, can also help on-site execution, but it will need to be deployed effectively by project managers.

6. INFUSE DIGITAL TECHNOLOGY, NEW MATERIALS, AND ADVANCED AUTOMATION

Despite the proven ability of new technologies, including digital technologies, and other innovation to lift productivity in other industries, construction lags significantly behind other sectors in its use of digital tools and is slow to adopt new materials, methods, and technology. Significant advances that are either being deployed or prototyped today can transform the effectiveness and efficiency of construction in three main areas: digital technologies, advanced materials, and construction automation. Digital technologies have spread the most rapidly. Our survey revealed an adoption rate of more than 44 percent among respondents. Planned adoption within the next three years is expected to reach 70 percent, far higher than adoption rates for materials and automation, which respondents said they expected to reach only 28 percent and 33 percent, respectively.

When discussing other ways to drive an improvement in productivity on-site, we have not included the impact of technology, but technological developments can transform productivity. There is evidence of ambition to innovate in pockets, and that the benefits are significant and attainable, but capturing the prize will require a significant change in attitudes across the industry.

ADVANCES IN DIGITAL TECHNOLOGY

There are four main digital trends capable of enabling the construction industry to achieve a step change in productivity, primarily by improving coordination and transparency:

- **Next-generation 5D BIM.** Virtual-design tools such as BIM enable the “virtual twinning” of projects. This involves creating a digital representation of the physical and spatial dimensions of a project, which helps those involved to make more effective and quicker decisions: 5D technology adds scheduling and cost layers to the 3D representation. Previous versions of BIM involved only 3D models, to be handed over to the eventual owners and operators of assets, but the addition of cost and schedule overlays enables 5D BIM to become a powerful visualization and project-management platform through the life cycle of a project. In the future, 5D BIM can be integrated with augmented- and virtual-reality technology to create seamless interaction between offices and the work site. Examples already exist, including the Microsoft Trimble HoloLens platform, which enables teams to interact with a 3D hologram of the project’s design using a wearable holographic computer, creating new ways to visualize, share ideas, and manage change on even the most complex projects.⁵⁵ BIM requires investment in the form of user license fees and the designation of a dedicated and trained BIM team. However, between 70

⁵⁵ Trimble Buildings.

and 80 percent of contractors perceive there to be a positive return on investment.⁵⁶ Among the top five benefits of BIM cited by contractors in the survey were fewer errors and omissions, less rework, and lower costs. The survey also found that firms with the deepest BIM engagement reported the highest return on their BIM investments. The survey found that contractors expect the percentage of their work involving BIM to increase by 50 percent on average, and that contractors in all markets were planning significant investments in expanding their BIM programs over the next two years, with an increased focus on internal and external collaboration, mobile hardware, and BIM software.

- **Digital collaboration and mobility.** Construction companies are inching away from paper-heavy processes, replacing them with digital workflows spanning steps from project concept to commissioning. They take the form of simple, intuitive and user-friendly apps that enable real-time collaboration and communication among crews, often loaded on handheld and mobile devices that help track the productivity of the workforce. The biggest advantages of digital collaboration are improving the transparency of processes, enabling collaboration in real time, and facilitating large-scale data mining. These apps are also easily synced with sensors, wearable devices, and desktop machines, and they can be used in a variety of ways, including productivity tracking, report generation, document management, material logistics, and inventory management. This is the fastest-growing and most penetrated area for digital technology in construction, and it is attracting the majority of venture and growth capital funding. Most large construction companies are deploying, or experimenting with, one or more such construction management apps. One example of this is Bechtel's partnership with Rhumbix, whose cloud-based platform, once complete, will allow real-time tracking of the location of the workforce with mobile devices and allow use of data analytics to monitor on-site safety, production, and performance.⁵⁷ Another example relates to implementing a cloud-based project control tower that seamlessly processes raw data on project-performance and visualizes them in an intuitive, real-time, and customizable dashboard format suitable for management decision making. One US company has successfully implemented this on more than 40 project sites, and uses this approach as its proprietary performance-monitoring platform.
- **Near-perfect surveying and geolocation.** Traditionally, the industry used electronic distance measurement for surveying, which was highly labor-intensive. Now photogrammetry and satellite positioning systems that produce high-resolution images are being introduced, but the post-processing time needed to convert the information into usable data makes it most useful for large sites. Light detection and ranging (LiDAR) laser scanners use optical lasers to detect thousands of points per second and then provide a 3D output. This can be used in conjunction with drones or handheld scanners. These technologies enhance the accuracy and quality of surveys of even inaccessible terrain and reduce the labor and time needed to conduct them. Contractors are also able to update BIM models dynamically based on these surveys, to track progress and monitor resources.

⁵⁶ *Prefabrication and modularization: Increasing productivity in the construction industry*, McGraw Hill Construction SmartMarket Report, 2011.

⁵⁷ Bechtel, 2015.

- **Internet of Things and advanced analytics.** Through the Internet of Things, sensors and communication (NFC) technology can be used to track asset utilization and performance of construction assets and equipment. They capture real-time data from crews, equipment, and stores to enable contractors to streamline their supply chains, reconcile material plans with physical availability, and analyze productivity. Companies also have the opportunity to deploy pattern- and trend-based advanced analytics for insights into the productivity of projects and day-to-day decision making. Recording more and higher-quality data and combining these data with analytics from the design to the building stages of a project will improve contractors' ability to develop better front-end estimates of a project's cost, obtain predictive trends and recommendations useful for decision making, and get a better handle on project risk (see Box 18, "Expert panel: Simon Williams, QuantumBlack"). Applying advanced analytics in the engineering division of a leading contractor using readily available data from email traffic, drawing revisions, team composition, human-resources performance data led to significant productivity improvements of as much as 25 to 30 percent. Contractors as well as owners already possess vast amounts of data; analytics techniques that disaggregate budgets and schedules down to hours, productivity, and wage rates per trade provide practical predictive insights for use in bids, estimates, and plans.

Box 18. Expert panel: Simon Williams, QuantumBlack

QuantumBlack's mission is to use big data and advanced analytics to improve performance across industries. In 2013, we did some work for the Crossrail project, a major new rail infrastructure project running through the center of London. Using a network of 250,000 sensors across the city, we sought to understand the spatial and temporal relationships among them to estimate missing readings and identify patterns of ground movements. Identifying signatures in the data that warranted investigation and improving the coverage and speed of data monitoring enabled the forecasting of near-term and end-state soil displacement and helped provide an early warning of large displacement events.

Our data analytics predicted the vertical movement of soil highly accurately in both the pilot and the enlargement tunnel on the project. Automating anomaly detection meant that information reached field engineers more quickly, and risk management was significantly improved. This system was deployed live for two years and allowed real-time access via an app with seven-day forecasting. This project delivered an estimated 20 percent savings on instrumentation and monitoring costs. The entire Crossrail project was retrofitted with the system developed by QuantumBlack. If the system been implemented initially, with flexible installation and maintenance contracts, we think that the saving could have been as much as 50 percent. The data signatures developed during this project can be reused across the network and in different forms of construction, such as sprayed concrete lining, tunnel bore machine, retained cut excavation, and compensation grouting.¹

¹ QuantumBlack was acquired by McKinsey & Company in December 2015.

ADVANCES IN MATERIALS TECHNOLOGY

The materials used in construction have a big impact on the productivity of the industry. A drive toward lighter-weight, more flexible materials facilitates both logistics and execution on-site. The increasing pressure of green construction is also encouraging development of new construction materials. Two areas of innovation are worth noting:

- **Concrete and steel construction.** Given that concrete has become the leading material used in large construction projects, even marginal advances will have a major impact on the industry.⁵⁸ Most notable are lighter, more flexible, and more versatile forms of concrete such as self-consolidating and self-compacting concrete. Its higher viscosity eliminates vibration and finishing while enabling single-point pouring and more intricate formwork, all of which save significantly on time and deliver large productivity gains. Steel is another material undergoing change. Companies such as Con-X-Tech are creating modular structural steel systems that eliminate the need for riveting or welding by relying on gravity connectors to create a rigid frame, again saving substantial time on-site.⁵⁹ In the longer term, more radical adaptations, particularly to concrete, are in development. The industry is experimenting with carbon nanotubes as a strong, very lightweight alternative to reinforcement. This would revolutionize productivity on-site through the elimination of reinforcement fixing times.
- **Alternative materials.** A selection of alternative materials is being developed, both structural and non-structural, and for high-end and affordable projects. Ethylene tetrafluoroethylene (ETFE), which is 99 percent lighter, stronger, more eco-friendly, better at light transmission, and more flexible than glass, is increasingly being used.⁶⁰ This material was first employed on a large scale at the “Water Cube” swimming venue at the 2008 Beijing Olympics, which cut energy costs by 30 percent. Since then the use of ETFE has increased about fivefold.⁶¹ New polymers and plastics are also having an impact on more mundane applications. In Rotterdam, city officials have approved a pilot project that uses recycled plastics to form modular road sections that would replace traditional asphalt construction and potentially last more than 50 years.⁶² Finally, a number of brick substitutes made of natural materials are being developed, including fly-ash bricks made from volcanic ash, sand, lime, and gypsum; compressed earth blocks made of soil with a small amount of cement; and ferrocement wall panels made of cement, sand, aggregates, fiber, and welded mesh. Similarly, roofs can be made of microconcrete tiles formed from cement, aggregates, and sand; ferrocement roofing channels can cut costs by 30 percent compared with traditional concrete roofing and have 60 to 75 percent lower deadweight.⁶³

ADVANCES IN CONSTRUCTION AUTOMATION TECHNOLOGY

Construction methods and equipment continue to progress, both increasing productivity and addressing limits such as constrained worksites in cities. The development and benefits of off-site fabrication are discussed in detail in the “Rethink design and engineering processes” section above. This section focuses on the development of technology that will accelerate execution on-site. Estimates suggest that the sector could automate 68 percent of the tasks carried out—one of the highest shares of any sector—and that, therefore, there

⁵⁸ Of the world’s 100 tallest buildings in 2013, 46 used concrete as the primary material, and an additional 36 employed concrete in combination with steel construction

⁵⁹ ConXTech.

⁶⁰ MakMax.

⁶¹ Number of notable building projects (projects mentioned in publications) as best available basis; year of completion was used.

⁶² “VolkerWessels introduces the PlasticRoad”, VolkerWessels press release, July 15, 2015.

⁶³ See Society for Excellence in Habitat Development—Environmental Protection & Employment Generation (SHEE); and *Going green: A handbook of sustainable housing practices in developing countries*, UN-Habitat, 2012.

is significant scope to improve productivity through these means.⁶⁴ The industry is starting to move toward automation in three key areas.

- **Additive construction, or 3D printing.** Although use of this technology is still in the early stages, it is now possible to print submodules or even complete concrete structures. In early 2015, Shanghai-based WinSun Construction, a pioneer of 3D-printed structures, unveiled a six-story apartment building built entirely with a 3D printer. In Dubai, a 2,700-square-foot office building was printed in 17 days at a cost of about \$140,000. Amsterdam-based MX3D is developing a technique to print a bridge made of steel.⁶⁵
- **Autonomous navigation technology for construction machinery enabled by LiDAR.** Autonomous heavy machinery has many benefits, including higher utilization ratios and reduction in operator costs. Komatsu, for instance, has a vast fleet of autonomous excavators, dump trucks, and bulldozers. Coupled with the company's intelligent machine control technology and advances in drone surveying, machines are now capable of conducting pre-foundation work autonomously. The full potential will be realized when a project's entire fleet of equipment is equipped with this technology. Combined with lean principles and the Internet of Things, the entire network of equipment could be optimized to provide near-perfect flow and asset utilization throughout the life cycle of a project.
- **Robotics and drone technology.** Robotics has had a dramatic impact on manufacturing productivity, and it could do the same in construction. Highly repeatable elements of construction such as bricklaying and concrete paving have already started to incorporate it.⁶⁶ Companies in Australia and the United States have achieved a masonry productivity gain of more than 100 percent through the use of bricklaying robots. A proof-of-concept paving robot called RoadPrinter is 20 percent more productive than comparable human paving teams.⁶⁷ Companies in India have used drones to string transmission lines spanning towers. Bridge building also has the potential for a powerful boost. Beijing's Wowjoint Machinery Company has developed a Segmental Bridge Launching Machine, which can extend farther than traditional cranes and rapidly drop modular bridge sections into place.⁶⁸ The Swiss Federal Institute of Technology is exploring drones to rapidly string cable bridges remotely and autonomously.⁶⁹

THREE MAJOR INTERVENTIONS ARE NEEDED TO MOVE PAST LONG-STANDING INNOVATION CHALLENGES AND SEIZE THE INNOVATION OPPORTUNITY

Despite the proven advantages of innovation, respondents to the MGI Construction Productivity Survey ranked underinvestment in innovation only seventh out of ten root causes of low productivity. Digital tools to improve processes outstripped innovation in both adoption rates and perceived impact. Research supports the notion that innovation is important for success. One study of the profits of firms that were generally innovative and

⁶⁴ Analysis draws on the US Bureau of Labor Statistics; O*Net; and Global Automation Impact Model.

⁶⁵ MX3D.

⁶⁶ See, for example, Markus Waibel, *Architects using robots to build beautiful structures*, IEEE Spectrum, September 20, 2011; Daniel Castro-Lacouture et al., *Concrete paving productivity improvement using a multi-task autonomous robot*, Proceedings of the 24th International Symposium on Automation & Robotics in Construction, Kochi, India, 2007; Sara Rao, "Brick-laying robot coming to a construction site near you," *Vocativ*, October 22, 2015; and David Nield, "Brick-laying robot can build a full-sized house in two days," *New Atlas*, June 30, 2015.

⁶⁷ Rob Ludacer, "This amazing road-building machine rolls out brick lanes like a carpet," *Tech Insider*, November 6, 2015.

⁶⁸ Rob Ludacer, "This 580-ton monster machine is building bridges across China," *Tech Insider*, October 23, 2015.

⁶⁹ Hal Hodson, "Spider drones weave high-rise structures out of cables," *New Scientist*, November 6, 2013.

those that were not found that the former had 15 to 20 percent higher margins than the latter across several industries.⁷⁰

Innovation in the construction industry continues to be constrained by deep-seated barriers, including a lack of emphasis on R&D, a high degree of fragmentation, and widespread risk aversion. We see three areas that should be prioritized:

Embedding innovation throughout the organization and across the value chain

Construction organizations have not fully developed the fundamental capabilities they need to innovate. The MGI Construction Productivity Survey found that a lack of internal processes to quantify and communicate the business case for innovation was most often cited by respondents as the primary reason a given technology has not been implemented. In light of this, contractors should ensure that they have a dedicated function for seeking and piloting new construction technology—a chief technology officer or chief innovation officer. At Bechtel, the chief innovation officer manages the company’s “future fund,” a pool of resources dedicated to supporting the creation and adoption of innovation.

One other notable aspect of embedding innovation into the organization is buying know-how through acquisition. In 2014, US commercial building firm Kiewit Corporation formed a wholly owned subsidiary, Kiewit Technology, which then acquired project-management software provider Et Alia. Kiewit Technology (now rebranded as InEight) also owns Hard Dollar, specializing in cost estimating and scheduling software, and Aeka Consulting, which focuses on mobile applications for the construction sector.⁷¹

Strengthening the link between technology suppliers and owners

The link between suppliers and owners is important for innovation but is often weak. In the MGI Construction Productivity Survey, the factor cited second most often was a lack of adoption of agreed standards by suppliers and their customers, an indication that the two need to work more closely (Exhibit 43).

To improve this situation, owners can significantly revamp their procurement requirements to require the use of proven technologies, especially on large projects, for example by mandating the use of 5D BIM on publicly procured projects. Nordic countries were particular pioneers in this regard with several state-owned bodies requiring BIM use from 2007. Other countries such as the United Kingdom announced the mandate deadline in 2011, several years before implementation in 2016 to allow time for the transition.

Owners should also adopt a reliability and life cycle-cost attitude, and work with contractors to understand the benefits of new materials and a greater array of sensors throughout the life of an asset. By taking a longer-term return on investment perspective, owners can begin to use fact-based and financially sound rationales to understand the full implications of innovations in the sector. Suppliers have an equally important role in strengthening their relationships with owners. They are often the players who are executing the most innovation, but this often goes unnoticed by the sector. Together, owners and suppliers can work jointly on industry standards for new materials and methods, clearing the way for contractors to seamlessly take up the baton during the project.

⁷⁰ Paul Gerovski, Stephen Machin, and John van Reenan, “The profitability of innovating firms,” *The Rand Journal of Economics*, volume 24, number 2, 1993.

⁷¹ See “Construction firm acquires technology provider,” *Constructech*, June 5, 2014; and InEight website.

Exhibit 43

The biggest barrier to digital technology is a lack of internal processes; for the adoption of new materials and methods, it is a lack of standards

Most important barriers to adoption by technology type

Frequency of ranking in top three most important barriers (n = 141)

		No internal process to quantify or communicate business case and benefits	No clear industry standard yet, subs and customers need to adopt	Management not interested, no budget at project level	Frontline workers insufficiently trained or unwilling to use	Lower-cost options available
Digital	Real-time collaboration	●	●			
	Collaborative mobility solutions	●	●			
	Digitized project workflows	●		●		
	Real-time workforce production tools	●	●			
	Sensor and NFC technology	●		●		
	Pattern-/trend-based advanced analytics	●	●			
	Surveying and inspection tools	●		●		
Materials	Modular construction	●	●			
	Durable and lightweight materials		●	●	●	
Automation	Advanced automation		●			●

SOURCE: MGI Construction Productivity Survey; McKinsey Global Institute analysis

Improving risk sharing of new approaches

Industry associations and regulators can facilitate an innovation transformation by working with owners, contractors, and suppliers to define new standards for emerging innovations, assist in providing financial resources for pilots, and showcase success stories. Grants and subsidies would be an effective way to support innovation.

To further reduce risk aversion, owners should co-invest in technology pilots with contractors and share costs and rewards proportionally. Ideally, this could start with smaller-scale projects to build confidence and experience before being deployed on larger projects.

Contracting structures can also be used to ensure that the risk and reward from innovation are correctly allocated across the actors. For a more comprehensive discussion of the benefits of different contracting structures to spread risk, see the “Rewire the contractual framework” section above.

7. RESKILL THE WORKFORCE

Construction productivity is heavily dependent on labor-force skills. Contractors, industry bodies, and governments should reconsider how to attract and train workers and how to share knowledge to build capabilities at scale across the industry. In the United States during the 2008–09 global financial crisis, hundreds of thousands of skilled construction workers were laid off. Since then, construction spending has rebounded, and companies now cannot find enough new skilled workers such as carpenters, plumbers, and electricians to take their places. The Associated General Contractors of America found that 69 percent of nearly 1,500 firms were having trouble filling hourly craft positions, the bulk of the construction workforce.⁷² In the United Kingdom, for instance, a 2015 survey by the Federation of Master Builders found that two-thirds of 8,500 small and midsize firms had turned down work because they didn't have enough employees.⁷³ Meanwhile, many workers are approaching retirement; losing them will further deplete the ranks, costing the industry expertise and experience.⁷⁴ Some areas of the world have turned to informal or migrant labor to fill the labor gap, but this is not a long-term solution. By their nature, migrant workers are transient, and employers have no incentive to invest in training beyond what is required for their project. We discuss three ways in which the construction industry should invest in its talent:

DEVELOP STRONG APPRENTICESHIP MODELS

Apprenticeships are an established and successful way of ensuring a pipeline of skilled workers into the industry. However, in several countries there are insufficient opportunities available. In the United Kingdom, an estimated 42,000 apprentices a year are needed to meet demand, but only 18,000 were enrolled in 2014–15.⁷⁵ In the United States, there has been no material increase in apprenticeships even while the industry has recovered from recession.

In addition to reviewing the number of apprenticeships available, the industry should also consider how to make them more attractive to young people in order to compete for the best talent. In a 2012 survey of both developed and developing countries, only 27 percent of respondents had a positive perception of construction jobs.⁷⁶ In many countries including South Korea, for example, the majority of young people feel academic paths are more valued than vocational paths such as apprenticeships.⁷⁷ Programs should become a stepping-stone to a career in construction, with opportunities to progress. Currently, there are insufficient institutional support and policy structures to increase the reach and acceptance of apprenticeship programs. Historically, relatively few apprentices stay with the employers who train them, and therefore employers are reluctant to invest in them.

Apprenticeship programs need to change. First, pathways from education to jobs must be clearer. In Germany, schools publicize apprenticeships and provide students with information to generate enthusiasm. Two-thirds of all school leavers in Germany elect to move on to vocational programs due to better information and effective program design.⁷⁸

Second, programs need to go beyond teaching a particular skill and seek to educate potential workers in broad terms about how to enter the industry and become successful professionals. German apprentices can develop into respected master craftspeople but are

⁷² *Two thirds of UK building companies turn down work*, Federation of Master Builders, August 19, 2015.

⁷³ "AGC workforce survey shows contractors have a hard time finding qualified craft workers," Associated General Contractors of America press release, September 1, 2016.

⁷⁴ Frances Marley, *Exploring the impact of the ageing population on the workforce and built environment*, Chartered Institute of Building, 2015.

⁷⁵ Apprenticeship statistics for England: 1996–2015, UK House of Commons Library.

⁷⁶ *Education to employment: Designing a system that works*, McKinsey Center for Government, January 2013.

⁷⁷ *Beyond Korean style: Shaping a new growth formula*, McKinsey Global Institute, April 2013.

⁷⁸ *Vocational training in Germany: How does it work?* Make It in Germany.

also able to switch into non-vocational roles through programs that follow a dual vocational training model combining on-the-job training with theoretical learning at a vocational school. In India, IL&FS Skills trains poor, less educated young people from rural areas for jobs in textiles, welding, fitting, and construction, among other fields. The public-private partnership trained around 9,000 people and achieved an 85 percent placement rate in 2012. The company uses a standardized curriculum delivered through a portable multimedia platform, combined with hands-on experience in simulated work environments. Partnerships with around 1,000 employers ensure that the curriculum is relevant and secures placements for those enrolled.⁷⁹ In the United States, the Automotive Manufacturing Training and Education Collective (AMTEC) developed its curriculum with the help of high-performing technicians from several auto companies who outlined every task they performed and the competencies required for each, and then ranked them on the basis of their importance. AMTEC then worked with employers to distill all this information into 60 study modules, each of which focused on specific skill sets.⁸⁰

Third, the construction industry could revamp its image to attract more young people. One way of doing this would be to adopt some of the characteristics of the technology industry, such as cross-functional teams, individual empowerment, flexible assignments, and an emphasis on learning and deploying the latest technologies. For example, researchers have carried out pilot programs applying “scrum” techniques from software project management to residential construction projects with success.⁸¹ Apprenticeship programs should use younger workers and successful former apprentices as role models to demonstrate the career possibilities ahead. Governments and industry groups can help to enhance the attractiveness of apprenticeship programs through partial funding. In the United States, the Labor Department is investing \$50.5 million in ApprenticeshipUSA.⁸² In Morocco, the government provided the initial capital investment for an Institute for Training Automotive Professionals in 2011 and went into partnership with Renault, which provided the curriculum and carried out the training.⁸³

Fourth, the construction industry historically has a poor record of achieving gender parity in its workforce.⁸⁴ In the United States, only 9.3 percent of the construction workforce is female.⁸⁵ The shift from manual labor, which is typically male-dominated, to new technology-enabled ways of working could mean increased interest from women. Construction needs to diversify its sources of talent to attract the best people, and higher female participation is a large opportunity. This opportunity is even greater in emerging markets where male domination is even more pronounced.

⁷⁹ *India's path from poverty to empowerment*, McKinsey Global Institute, February 2014.

⁸⁰ AMTEC curriculum, certification, and assessments, Automotive Manufacturing Training and Education Collective, 2011; and *Education to employment: Designing a system that works*, McKinsey Center for Government, January 2013.

⁸¹ Thomas Streule et al., “Implementation of scrum in the construction industry,” Creative Construction Conference, 2016.

⁸² *Factsheet: Investing more than \$50 million through ApprenticeshipUSA to expand proven pathways into the middle class*, White House Office of the Press Secretary, October 2016.

⁸³ *Education to employment: Designing a system that works*, McKinsey Center for Government, January 2013.

⁸⁴ McKinsey and MGI have written extensively on gender issues in the workplace and beyond. See, for example, *Making the breakthrough*, Women Matter 2012, McKinsey & Company, March 2012; *The power of parity: How advancing women's equality can add \$12 trillion to global growth*, McKinsey Global Institute, September 2015; and *Women in the workplace*, LeanIn.org and McKinsey & Company, September 2015.

⁸⁵ Current Population Survey 2015, US Bureau of Labor Statistics.

Finally, apprenticeships also need to ensure that programs provide skills that will be immediately useful for starter jobs in the industry. A 2012 survey found that only 45 percent of youths and 42 percent of employers felt that graduates and new hires were adequately prepared for an entry-level position in their chosen field of study.⁸⁶ Technologies such as digital design, collaboration, and mobility tools have changed and will continue to change, and the nature of construction work and apprenticeships must continue to evolve beyond basic trades in order to be successful. The best way to make future apprentices work-ready is for the industry to get actively involved in the design of programs up front, teaching and investing in the best students through scholarships and internships. Apprentices need to be viewed as a vital source of talent and the future of the industry. Examples of successful apprenticeship programs include those run by Siemens and Crossrail (see Box 19, “Examples of apprenticeship programs”).

⁸⁶ *Education to employment: Designing a system that works*, McKinsey Center for Government, January 2013.

Box 19. Examples of apprenticeship programs

Siemens UK apprenticeship scheme. Siemens employs around 14,000 people in the United Kingdom, where it runs a successful apprenticeship scheme to source and train talent. Today, the company has more than 500 apprentices working on topics including energy management, wind power and renewables, and electrical engineering. Siemens works with a number of local further education colleges to identify apprentices, and its program has been rated outstanding by Ofsted, the UK education regulator and inspector. The apprenticeship scheme views participants not as a source of labor but as a way of sourcing talent. This is demonstrated by the fact that a high percentage of apprentices get jobs at Siemens, with the rest going to university. Role modeling is also key: more than 50 percent of general managers hiring apprentices are former apprentices. Finally, rather than focusing on providing only expertise to succeed in their current role, Siemens provides apprentices with a broad range of engineering skills, putting strong emphasis on analytical and problem-solving skills. These tools are ones apprentices require in order to progress onto managerial and leadership roles in the future.

Crossrail apprenticeships. At a cost of £14.8 billion and with an expected cumulative 55,000 people employed by its planned completion in 2018, Crossrail is Europe’s largest infrastructure project. It also suffered from a shortage of specialist experience, according to one analysis. To address this issue, Crossrail set a target of training 400 apprentices over the lifetime of the project and established the Tunnelling and Underground Construction Academy (TUCA), in partnership with industry bodies. The company insisted on apprenticeship targets and standards as a precondition for all contractors. Contractors were given the freedom to tailor their apprenticeship schemes to meet their specific needs, but Crossrail put in place a robust system for monitoring and assessing performance against its targets and standards. Contractors that demonstrated high performance were asked to share best practices and distinctive features with other contractors. All of this resulted in 600 apprentices being recruited and trained as of July 2016. TUCA apprenticeships specifically addressed the shortage in skills in tunneling and underground construction and provided training for existing workers in these specialties in order to help meet future demand. Crossrail estimates that TUCA will have a return on investment of 2.3 to 1 by the end of the project.¹

¹ Georgina Bigam and Nathan Pascutto, *Addressing skills gaps through direct intervention (TUCA)*, Tunnelling and Underground Construction Academy case study, September 27, 2016.

INVEST IN TRAINING FRONTLINE WORKERS

The industry should consider how to enhance the skills of the existing workforce to boost productivity. The MGI Construction Productivity Survey indicated that 48 percent of respondents disagreed or strongly disagreed that they currently offer “a continuous training program to induct and train young engineers and managers and solicit ideas from them for optimizing project delivery.” From the survey, industrial contractors lag behind their counterparts in civil and building segments on training their workers. Further resources are required to train frontline workers in the skills required in site manager and other supervisory roles to enable growth beyond the frontline.

A focus on broadening the range of skills being developed in the industry is needed. In recent years, construction companies have increased their focus on developing project-management skills, which is a positive step, but there has been less emphasis on developing the skill sets of frontline workers, which could also have significant impact for the industry. For project management, it is important to ensure that people with the correct skills are being asked to undertake these roles. To be a successful project manager requires an analytical, forward-looking approach to ensure robust planning and not a fire-fighting attitude.

For frontline skills, research by McKinsey’s Organization Practice on adult learning and capability building suggests that adults tend to learn best when classroom “forum” lessons are heavily supplemented by practical field work, which enables the learning loop to be completed and internalized into effective habits. Applied to construction, which has recently turned its focus to acquiring project-management certifications, textbook lessons typically tend to have less impact than intended unless they are paired with ready application in the field so that workers can incorporate practical lessons learned. In addition, where frontline training exists, it has tended to focus on a single skill such as installing insulation, which does not prepare the worker for a supervisory-level job in the future. This overspecialization of training is increasingly out of step in an industry in which new technology is blurring the boundaries between traditional trades, with disciplines becoming more interwoven rather than sequential. Construction technology, such as automated robotic welding, will reduce the number of craft workers required. Therefore, teaching frontline workers a blend of skills will be a useful step in creating a future-proof workforce. The Construction Industry Institute found that using multiskilled labor can reduce total project costs by 5 percent and reduce the workforce needed on a project by 35 percent.⁸⁷ In addition, multiskilled workers are better equipped to withstand demand shocks in construction by being able to cover multiple roles, helping firms to manage cyclicalities in the industry.

Another factor is the aging of the construction workforce, which puts pressure on the industry’s skill pool. In Hong Kong, it has been estimated that, in 2013, 12 percent of the construction workforce was aged over 60 and therefore at retirement age, and a further 44 percent was aged over 50.⁸⁸ The industry is set to lose a significant amount of expertise in a short period. To address this, it should take steps to retain experienced workers and their skills, retraining them to take supervisory or training roles that would help them hand down their knowledge to younger workers. Aging workers should also help train temporary or migrant workers who are required due to cyclicalities and local labor shortages. Better training is essential, but it may be difficult for small and medium-sized firms to offer aging workers retraining and flexible working options; in these cases, trade unions could potentially lend support.

⁸⁷ Rebecca C. Burlison, *An analysis of multiskilled labor strategies in construction*, Construction Industry Institute, June 1998.

⁸⁸ Jacky Y. K. Ng and Alan H. S. Chan, “The ageing construction workforce in Hong Kong: A review,” *Proceedings of the International MultiConference of Engineers and Computer Scientists 2015*, volume II, IMECS 2015, Hong Kong, March 18–20, 2015.

Another way to enhance productivity is to make training more efficient. It is typical for less experienced workers to learn by observing a more experienced colleague. However, this is inefficient—the less experienced worker can spend up to 80 percent of the working day observing and adding no tangible value. Instead, less experienced workers could be assigned the basic elements of a task, leaving the more complex finishing elements to the experienced worker and reducing idle time. Experts suggest that this could result in a 30 to 40 percent productivity improvement in each crew. While this cannot be replicated in all crews, the aggregate productivity increase for the whole project could be on the order of 5 percent.

INVEST IN KNOWLEDGE MANAGEMENT

Transfer of knowledge within the industry is limited. Projects exist independently of each other, and it is too unusual for best practices to be communicated and deployed elsewhere. This undermines productivity.

Workers from engineers to frontline tradespeople need to be empowered to solve problems and increase productivity day to day. Technology better equips workers to communicate with one another and take advantage of informal channels to share best practices. Firms need to create a culture in which on-site knowledge sharing is encouraged and rewarded. Small individual efficiency improvements communicated to other workers can add up to large improvements across a project. Investment in knowledge-management systems, including software tools, company intranets, and libraries, enables best practices to be codified and shared among projects. In addition, a few companies have “gamified” knowledge sharing and created a culture of healthy internal competition, making it productive for workers to readily share capsules of knowledge through newsletters, video clips, and posters widely circulated within the organization. The results of such sharing can be significant for productivity and organizational energy (see Box 20, “Fluor’s knowledge-transfer system”).

Box 20. Fluor’s knowledge-transfer system

Fluor specializes in engineering, procurement, construction, maintenance, and project management. The company invested in knowledge management because it had experienced difficulties in maintaining consistency and standards across projects.

The company built a knowledge-management system across four key areas: connecting people, codifying and sharing knowledge, anticipating knowledge gaps and requirements, and accelerating expertise development for employees. Initially, Fluor focused on promoting knowledge sharing across the organization. The focus has since shifted to promoting collaboration within and across projects as well.

The company uses two systems: Knowledge OnLine for knowledge transfer between projects, and Project OnLine for knowledge transfer within projects. Knowledge

OnLine enables experts to share expertise globally; Fluor has set up knowledge communities that develop expertise and then use it consistently across projects. Project OnLine promotes collaboration and knowledge sharing of best practices among stakeholders; it can be made accessible to clients, subcontractors, and suppliers to drive collaboration on-site. Close to 100 percent of the company’s staff participates in knowledge communities. The Knowledge OnLine system has won a Lotus Beacon Award. Fluor was named one of the Global Most Admired Knowledge Enterprises (MAKE) for the tenth consecutive year in 2015.¹

Acquiring and retaining the best possible talent in the industry is a longtime challenge. The construction industry needs to ensure that it has the apprenticeship programs and training to attract the best and to maximize their potential.

¹ The KNOW Network.

The industry goes through cycles of high and low activity that lead to significant reliance on temporary and migrant workers whose work is typically lower in productivity. In an ideal scenario, firms would support a permanent workforce that is adequately trained, but this is challenging in periods of low demand and in certain subsectors such as industrial construction where projects are spread across geographies. To address cyclical, firms need, at a minimum, to maintain a smaller core group of high-skilled workers who can disseminate their knowledge and train the additional workforce in a short period to maximize productivity. Some best-practice companies create internal “academies” in which seasoned veterans employed as full-time coaches circulate through organizational units, coaching younger managers and workers, updating the organizational playbook, cross-pollinating effective practices, and spending time on practical training and feedback. Such academies have generated high-impact results. In the future, a shift toward a construction production system as we will describe in Chapter 4 would reduce the number of workers required on-site, and through greater scale create sufficient demand to maintain a highly skilled and productive workforce.



Action in all seven areas could radically improve the productivity of projects by an estimated 50 to 60 percent. But is that all that can be done? Replacing today’s project-based system, with all its complexities and cost, with a system of mass production has the potential to boost productivity by orders of magnitude more than incremental change. We discuss such a production system and what might be in the future in the next chapter.

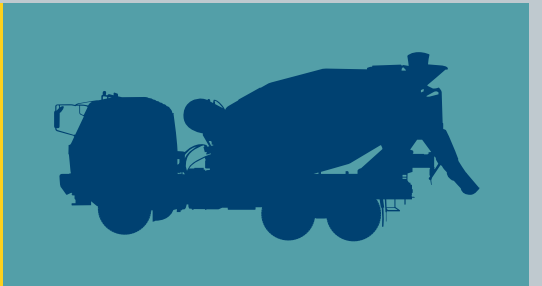
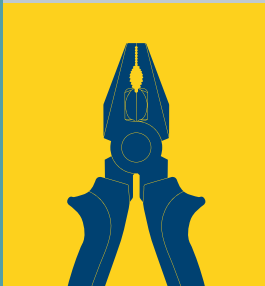
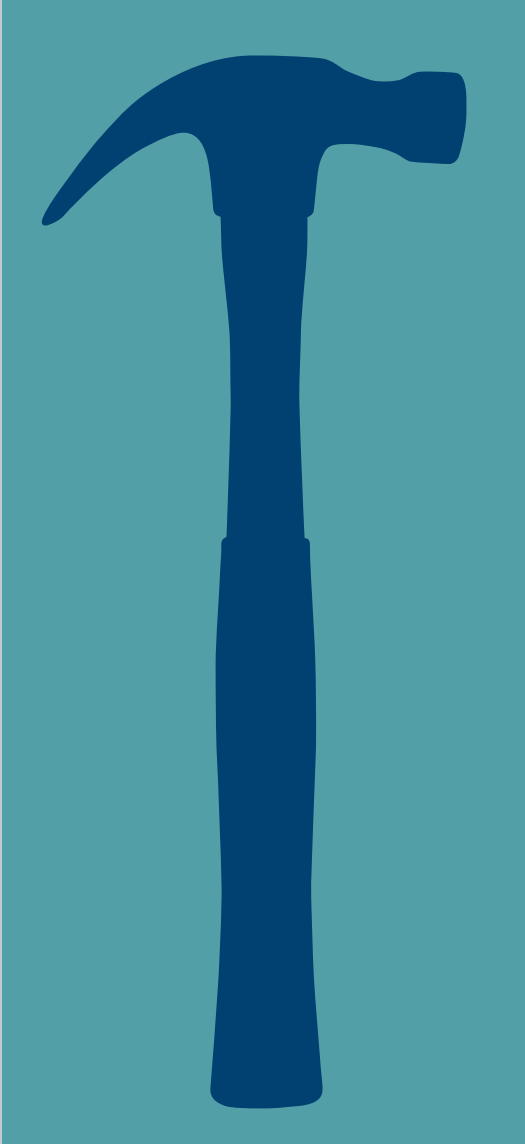
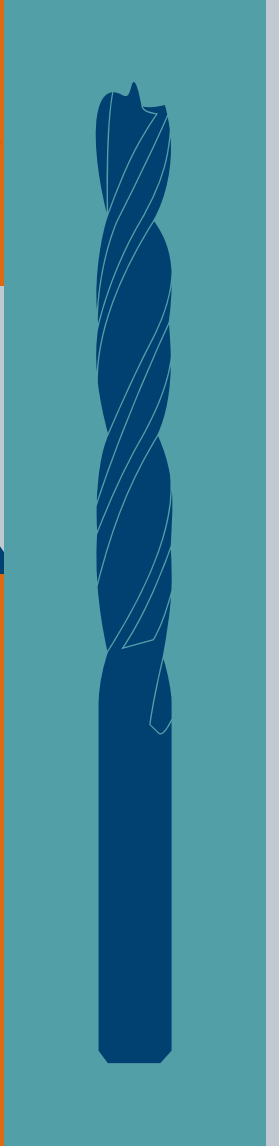
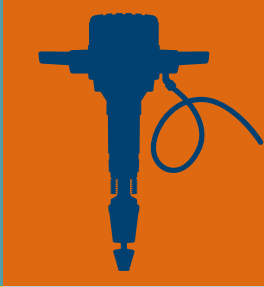



CASE STUDY: UNITED KINGDOM

Productivity and demand trends. Although UK construction productivity has trailed that of the total economy and been relatively flat since 1995, it is high by international comparison in nominal terms. Facing a need to renovate the infrastructure built after the end of World War II, in 1989 the government lifted its restriction on private funding of public-sector projects and started actively promoting public-private partnerships. Their number steadily increased during the 1990s, likely contributing to higher productivity, because these projects were more likely to be on time and on budget. However, barriers remain to higher productivity growth, including a lack of incentives to invest in technology due to high fragmentation of the industry—40 percent of construction contracting jobs are self-employed, compared with 15 percent across the economy. In addition, the government’s role as a client is fragmented, with different commissioning agents at the national and local levels.

Government interventions and regulatory setup.

The UK government has been an activist on construction productivity for 20 years, but analysis of the impact of its policies is inconclusive. In 1999, it launched the Achieving Excellence in Construction initiative, which established demonstration projects focused on instituting best practices, using computer modeling, standardized components, and pre-assembly as much as possible,

and aiming to improve productivity by 10 percent; the initiative also emphasized improving education and skills, and some universities developed building-design degrees. Most recently, the government earmarked £1.7 billion in its 2016–20 construction strategy to further boost productivity in public-sector construction and support 20,000 apprenticeships. To drive innovation, the government holds competitions to provide R&D funding.

Technology investments. UK construction is facing a 20 to 25 percent decline in its labor force within a decade, according to Mark Farmer’s review of the UK construction labor market. The sector relies heavily on migrant labor—in London and the South East, migrants make up more than half the workforce—but this may not be sustainable if departure from the European Union ends free movement of people from Europe. Greater use of prefabrication may be the answer to such shortages. However, in general, investment in labor-efficient technologies has been relatively low compared with other countries. The government mandated the use of BIM for all public-sector projects by 2016, but that covers only about one-quarter of UK construction projects, and the private sector has thus far been risk-averse and unconvinced about the investment case for new technologies. Significant tax incentives through the government’s R&D Tax Relief are being claimed, but only on a small scale.¹

Productivity evolution, 1995–2015

Gross value added¹ per hour worked
Index: 100 = 1995

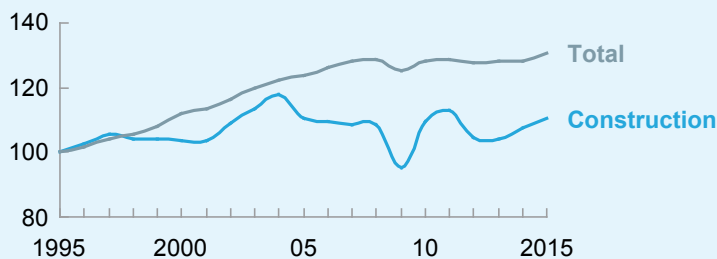

Compound annual growth rate %

Total 1.34
Construction 0.49

Sector size and composition

2015 \$ billion

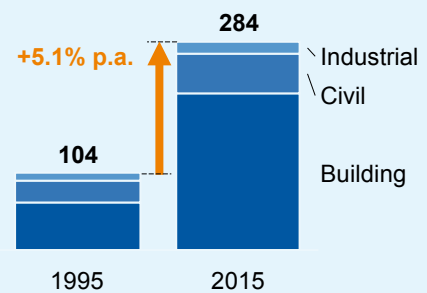

\$41 per hour

2015 construction productivity level

\$46 per hour

2015 average economy productivity level

\$22.0 billion

Annual value lost¹ to low productivity

¹ 2005 USD, non-PPP adjusted

SOURCE: OECD; World KLEMS; IHS; ITF; GWI; World Energy Outlook; Infrastructure UK; UK national accounts; McKinsey Global Institute analysis

¹ *United Kingdom—England, PPP units and institutional framework*, European PPP Expertise Centre, June 2012; *Government construction strategy: 2016–2020*, Cabinet Office and Infrastructure and Projects Authority policy paper, March 23, 2016; *Construction labour market in the UK: Farmer review*, Department for Business, Energy and Industrial Strategy and Department for Communities and Local Government, October 17, 2016; *A new approach to public private partnerships*, HM Treasury, December 2012.



CASE STUDY: AUSTRALIA

Productivity and demand trends. With a fivefold population increase since the end of World War II and a mining boom, Australian construction has been in high demand. Numerous high-productivity, large-scale mining and liquefied natural gas projects accounted for a high share of total construction from 2003 to 2012. In 2015, almost half of industry revenue came from civil and engineering construction, and 65 percent from megaprojects. Unionized frontline workers are paid well and receive skills training, attracting better talent than in other countries. Highly productive fly-in, fly-out workers are often used on large projects, which tend to be unionized. Because unions insist on high safety standards, Australian construction projects are meticulously planned to avoid labor issues. The industry also has strong middle management. Potentially bearing down on high productivity is the fact that companies sometimes employ lower-skilled subcontractors at lower wages, only to hire higher-skilled, higher-paid subcontractors for rework.

Government interventions and regulatory setup.

Australia has one of the highest shares of public-private-partnership (PPP) construction projects in the world. The government introduced a new PPP procurement model in the 1990s, increasing investment by the private sector and contributing to an estimated 10 to 30 percent life-cycle cost saving. More recently, Australia cut the number

of procedures for obtaining a construction permit from 25 to 14 and the average permit processing time from 150 to 112 days. It also introduced a national building code and instituted special courts to expedite land-acquisition disputes. However, building regulations and occupational licensing continue to vary among states, which creates competition but also inefficiencies. High-impact government initiatives specifically targeting productivity have not been launched.

Technology investments. Strong union activity and high wages have contributed to the adoption of labor-saving technologies, including BIM, big data, drones, and virtual reality. However, investment in technology and innovation has been comparatively low, possibly due to limited competition. Use of prefabrication and off-site manufacturing is low, partly reflecting logistical challenges in such a large country and the fact that Australia does not historically have pronounced manufacturing capabilities. Australia's first CLT building was built in 2012 with imported CLT; it is opening its first CLT plant in 2017. The competitive procurement system also does not encourage innovation, as subcontractors are not incentivized to share innovative ideas until too late in the process, when the impact is limited. It remains to be seen how competition from the technology-based foreign companies that have started to win government tenders in recent years may disrupt the industry.¹

Productivity evolution, 1995–2015

Gross value added¹ per hour worked
Index: 100 = 1995

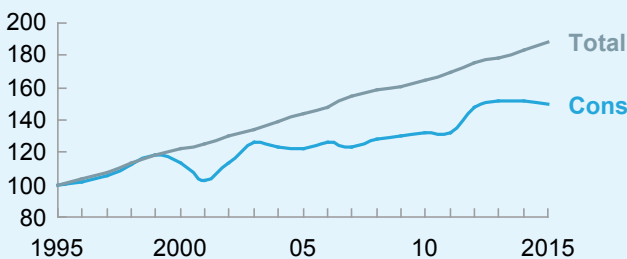

Compound annual growth rate %

Total 3.2
Construction 2.1

Sector size and composition

2015 \$ billion

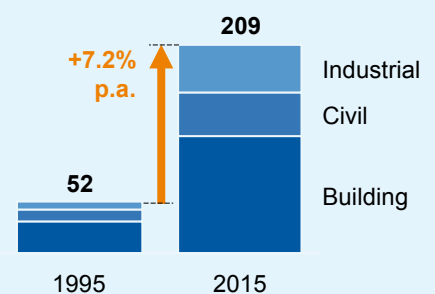

\$28 per hour

2011 construction productivity level

\$36 per hour

2011 average economy productivity level

\$24.2 billion

Annual value lost¹ to low productivity

¹ 2005 USD, non-PPP adjusted

SOURCE: Australian Bureau of Statistics; The Conference Board 2016; OECD; World KLEMS; IHS; ITF; GWI; World Energy Outlook; Asian Development Bank; Australia national accounts; McKinsey Global Institute analysis

¹ *Public infrastructure: Inquiry report*, Australian Government Productivity Commission, July 14, 2014; *Performance of PPPs and traditional procurement in Australia: Final report for Infrastructure Partnerships Australia*, Allen Consulting Group, November 30, 2007; Brett Bates, "The construction productivity crisis in Australia," *Construction News*, January 11, 2017; Martin Loosemore, "Improving construction productivity: A subcontractor's perspective," *Engineering, Construction and Architectural Management*, volume 21, issue 3, 2014; John Slater and Nick Cater, *Constructing a better future: Restoring order and competition in the building industry*, Menzies Research Centre, 2016.



Prefabrication

© Maria Luisa Corapi/Getty Images

4. A PRODUCTION SYSTEM COULD BOOST PRODUCTIVITY TENFOLD

The seven areas that need to be addressed can boost productivity by some 50 to 60 percent. But a transformative five- to tenfold increase in productivity would be possible if construction were to move to manufacturing-like system of mass production with a much greater degree of standardization and modularization and the bulk of construction work taking place in factories off-site (Exhibit 44).

Exhibit 44

A production system in construction would look radically different from the current project-based approach

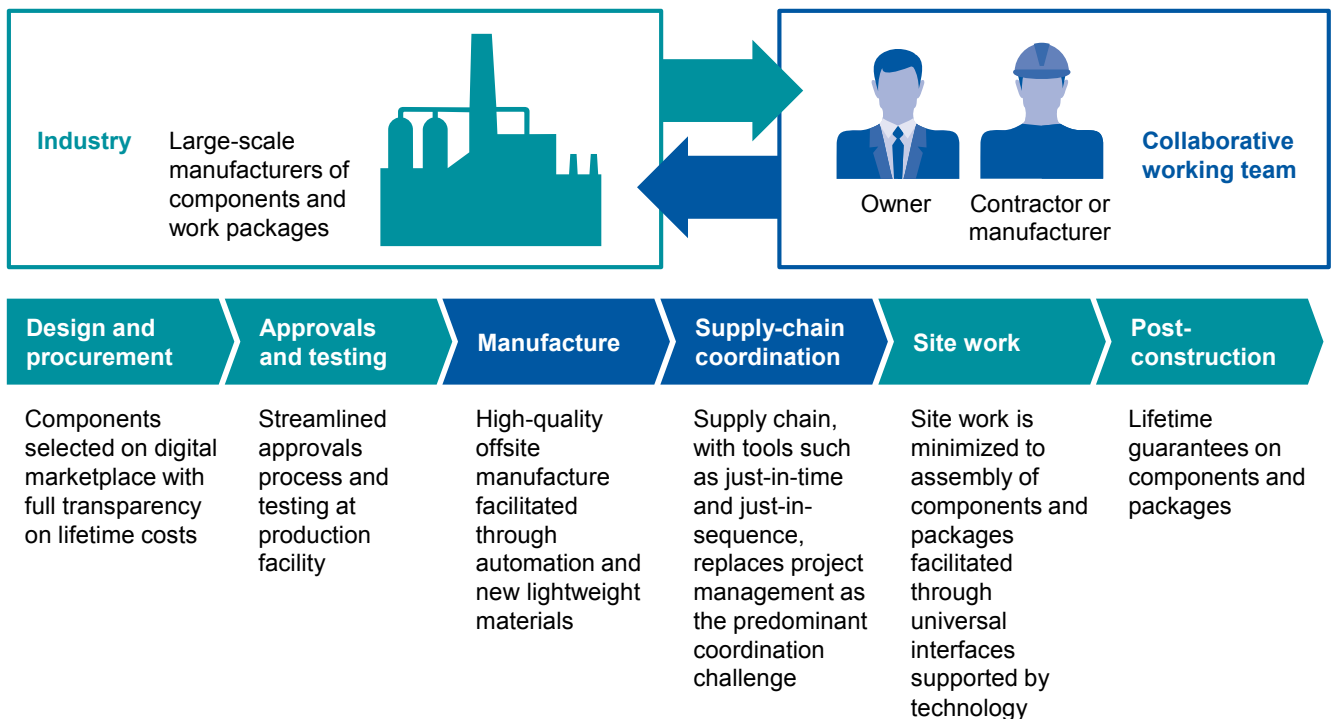

SOURCE: McKinsey Global Institute analysis

There would be far greater use of repeatable design, off-site prefabrication of many components, and only assembly and minimal finishing work on-site. Owners would choose entire designs or specific components from a suite of options offered on digital and offline marketplaces by producers, developers, and other intermediaries. Owners and developers would potentially contract with one turnkey solutions provider that would connect contracting and manufacturing work, prefabricating repeatable modules in a manufacturing facility before assembling on-site.⁸⁹ Alternatively, a new construction ecosystem would emerge in which parts manufacturers work closely with the contractors responsible for assembly on-site. Either system would drastically reduce the amount of labor needed on-site and would boost productivity.

⁸⁹ Turnkey is a type of project that is sold complete to the buyer at a price inclusive of materials, labor, and other costs.

McKinsey has estimated that repeatable components and prefabrication in the industrial segment can generate an increase of 20 to 30 percent in value. In a McGraw-Hill survey, 6 percent of firms that used prefabrication and modularization reported a reduction in schedules, and 42 percent reported a reduction in cost of 6 percent or more.⁹⁰ Any move toward shared design and scale in construction would be similar to the shift already seen in much of manufacturing.

The large-scale, lower-risk, higher-innovation dynamic achievable on large projects has been amply demonstrated in the case of the Chinese high-speed rail network. The cost per kilometer of this network is about 65 percent lower than it would be in the United States and around 80 percent lower than in the United Kingdom (Exhibit 45).⁹¹ Scale has been an important factor in delivering these benefits. The rail network extends 10,000 kilometers. All viaducts were standardized, with spans limited to either 24 meters or 32 meters, and were fabricated at temporary factories erected nearby. Each beam was then transported up to eight kilometers on a specialized vehicle with up to 18 axles, and launched over the viaduct columns using specialized equipment.⁹²

Exhibit 45

Increased scale, standardization, and new technologies are enabling China to deliver projects at a much lower unit cost

Cost of high-speed rail in China vs. rest of world
\$ million per kilometer¹

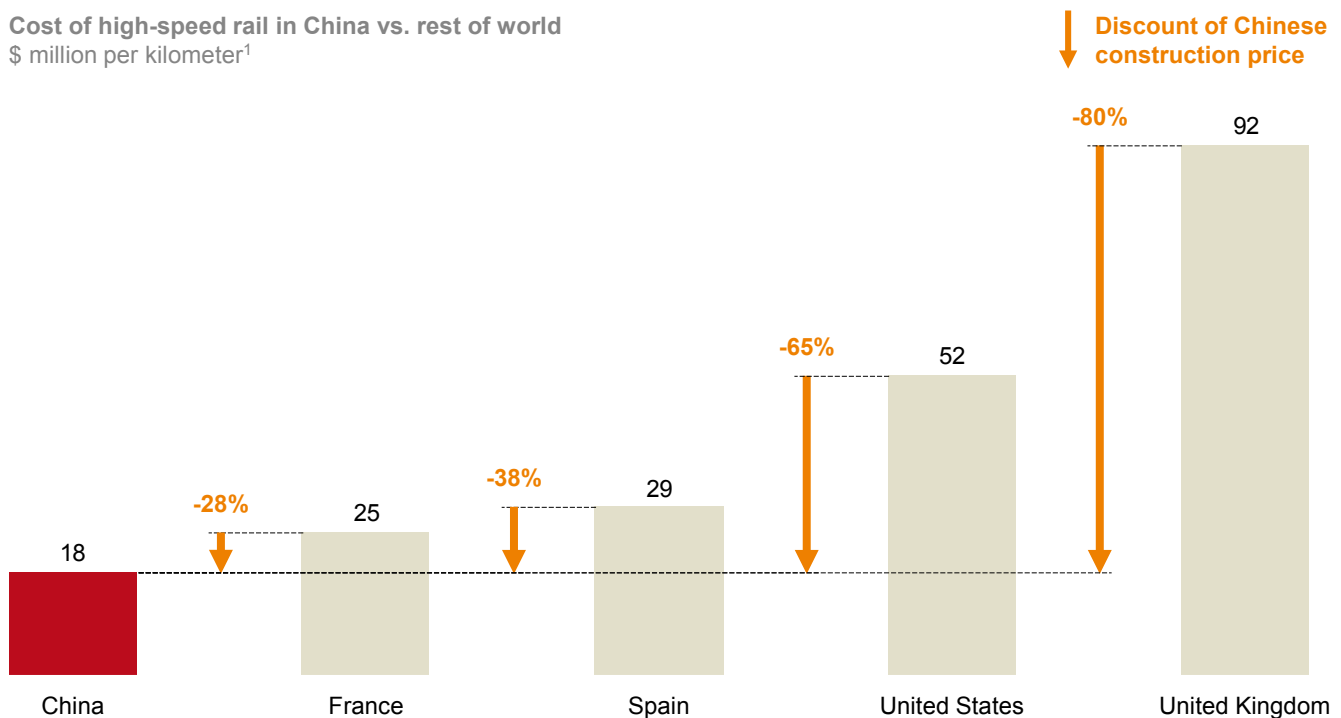

1 Calculated as average of those listed in World Bank reports: United States (1 project), Spain (3 projects), France (1 project plus 4 under construction), China (6 projects), and of high-speed 1 (constructed) and high-speed 2 (under construction) in the United Kingdom.

SOURCE: World Bank; *The Telegraph*; McKinsey Global Institute analysis

⁹⁰ *Prefabrication and modularization: Increasing productivity in the construction industry*, McGraw Hill Construction SmartMarket Report, 2011.

⁹¹ Gerald Ollivier, Jitendra Sondhi, and Nanyan Zhou, *High-speed railways in China: A look at construction costs*, China Transport topics number 9, World Bank, July 2014.

⁹² *Ibid.*

THE USE OF OFF-SITE PREFABRICATION AND MODULARIZATION IS A POWERFUL DRIVER OF ON-SITE PRODUCTIVITY

Prefabrication and modularization are increasingly moving off-site. Drawing on expert interviews and industry observations, McKinsey has estimated that this can reduce build time significantly because productivity is higher in a controlled environment such as a factory than it is on-site. Very broadly, the cumulative 760 percent increase in manufacturing productivity since the 1940s illustrates the opportunity to achieve higher productivity in a factory setting.

Manufacturing larger modules remotely reduces on-site complexity since fewer activities occur on-site. This is particularly relevant for projects in harsh environments, such as Arctic oil production and mining in remote locations. Another benefit of off-site prefabrication is a reduction in the labor force required. This can be particularly beneficial in unattractive locations since off-site manufacturing can shift work to areas where there are more skilled workers or lower labor costs, to maximize productivity and reduce capital expenditure. This may raise concerns among labor unions, but these can be addressed by unionizing both on-site and off-site work.

Prefabricated parts can also offer higher safety, better quality, and lower rework rates since the manufacturing process enables more efficient and faster inspections and quality checks. The increased use of manufacturing technology and automation can also reduce human error and increase consistency. This ensures that prefabricated parts and units arrive on-site in a condition that requires little additional remedial work before or during assembly, thus reducing build time.

Off-site prefabrication is becoming more common in industrial construction projects because of the challenges contractors face on those jobs. The gains industrial contractors have experienced mirror advances on residential projects for which companies are using modularization as a way of increasing productivity and simplifying the build process.

One of the major hurdles to successfully making the transition is that, unlike manufacturing that has steady demand for a repeatable design, construction is characterized by bespoke designs and unpredictable demand. Predictability of demand is vital if companies are going to invest in productivity-enhancing capacity and innovations. MGI has found that an automated facility producing sufficient cement slabs and walls for 12,500 housing units could cost about £30 million. Only an assured level of demand can justify such an investment. Prefabricated elements tend to be more capital-intensive and therefore require certainty about the scale of demand in order to justify the capital investment (Exhibit 46). We have seen many instances of a demand boost in construction not translating into higher productivity but, on the contrary, rather into hiring into more and more unskilled workers to raise output at all cost.

Exhibit 46

A plant to produce pre-cast building components can break even at 5,000 to 8,000 housing units annually

Break-even scale for 3,000- to 30,000-unit pre-cast plants¹

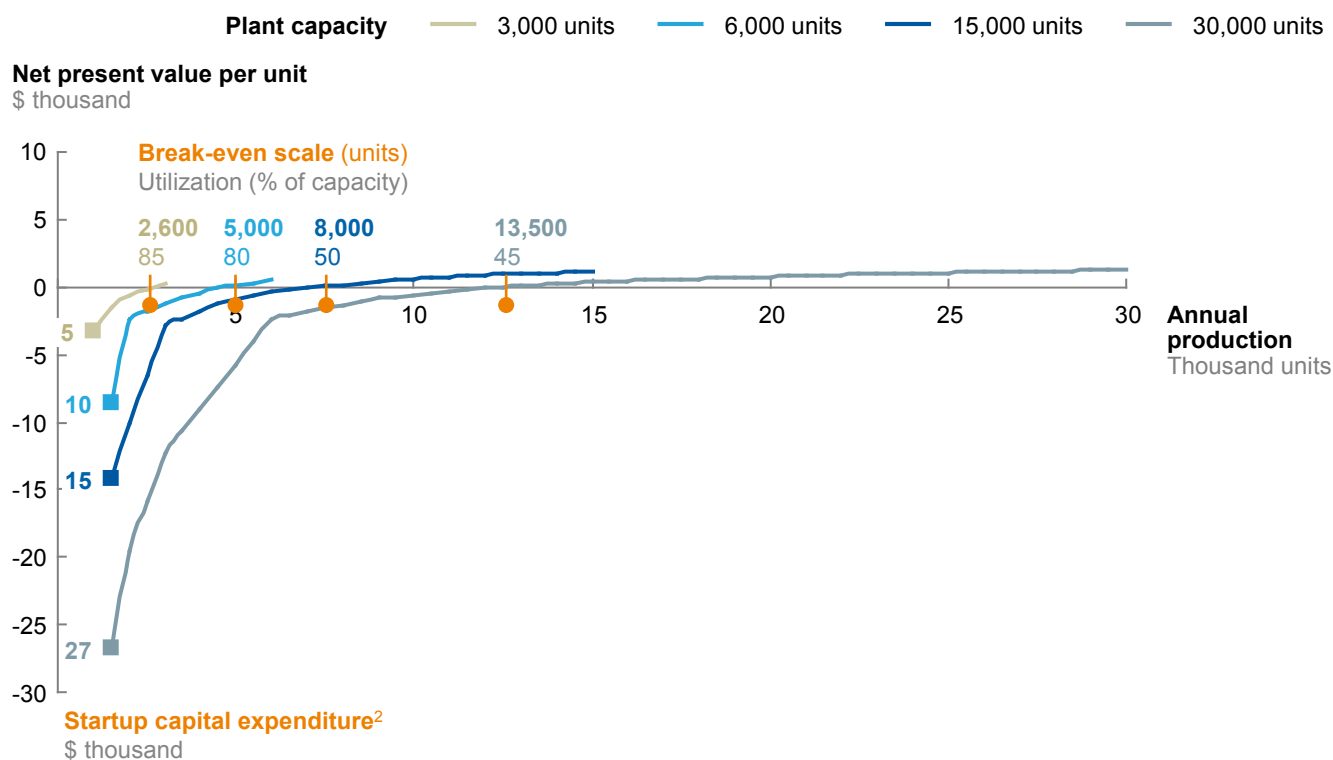

1 Assumptions: Average cost of capital, 10%; unit price, \$19,500; EBITDA margin, 10%; structure share of revenue, ~30%; depreciation/lifetime of plant, 10 years; maintenance, 0.5% of revenue; corporate tax rate, 25%; debt share of capital expense, 70%; interest rate, 5%; standard unit size, 50 square meters.
2 Based on manufacturer business plans. Capital expenditure figures based on assumption of low labor cost.

SOURCE: *Scaling-up affordable housing supply in Brazil: The My House My Life programme*, UN-Habitat, 2013; KPMG; Turner and Townsend; expert interviews; publicly available information of manufacturers; McKinsey Global Institute analysis

EXAMPLES INDICATE POTENTIAL TO INCREASE PRODUCTIVITY FIVE- TO TENFOLD

Examples of companies that have adopted a production system indicate that the productivity gains could range between fivefold and tenfold. Barcelona Housing Systems (see Box 21), which builds replicable four-story multifamily buildings, aims to have a full production system in place in 2018 and to use five to ten times less labor per unit than traditional construction while still boosting employment in the local area due to the sheer scale of units produced. Seattle-based Sustainable Living Innovations (see Box 22) builds residential blocks using a production system, reducing craft work on-site by 85 percent and the cost of units to 35 percent below the market rate once the full system is in place. It hopes to produce buildings as cheaply as those that are wood framed. Maison Laprise, a residential home builder based in Quebec, Canada, prefabricates up to 90 percent of panels and modules in a factory (see Box 23). Broad Sustainable Buildings of China, which operates in a very different part of the construction industry, constructs large buildings such as hotels (see Box 24). Again, the company prefabricates 90 percent of what is needed on-site in the factory, speeding up the build enormously. It can build a 30-story hotel in just 15 days and estimates that its buildings cost 10 to 30 percent less than those built in the traditional way. Finnish industrial company Outotec (see Box 25) estimates that its mobile flotation plant for small mines calls for 20 percent less capital investment, requires 30 percent less labor, and is 30 percent faster to install than alternatives. Dramatic time and cost savings reported—or aspired to—by these firms add up to much higher productivity.

Box 21. Production system case study: Barcelona Housing Systems

Barcelona Housing Systems is in the early stages of its planned move toward a full production system of housing. The company already has prototype projects in four countries—Chile, Croatia, Ecuador, and the United Kingdom—and aims to have a full production system in place by 2018. Eventually, the aim is to achieve cost per square meter of floor space of well below \$400 and to raise productivity five- to tenfold compared with traditional cement-based on-site construction (Exhibit 47). The production system has a number of important attributes:

Scale and repeatability: The company specializes in city-scale construction. It aims to develop more than 10,000 housing units per project, helping to amortize the cost of manufacturing facilities. It uses a replicable design of four-story multifamily buildings that mix housing, retail, and service-oriented office space. The company reconfigures the number of units per building as well as facade and design elements without changes to the structural design.

Prefabrication and assembly: Everything is designed for speed and efficiency. The company prefabricates modules using lightweight steel frames in a factory on-site or nearby. This choice of materials makes logistics more manageable because they can be transported in standard 25-foot containers and allows lower-cost foundations. A limited menu of designs allows for slightly different configurations, but all are built from combinations of only four different panels. They can be built by non-skilled workers with only five weeks of training per panel. Staircases are built first to avoid having to use scaffolding. The goal is to complete construction on-site in six days.

Sustainability: The company embeds sustainable elements in its buildings, integrating solar cells on the roof and including rainwater harvesting as standard. The design has achieved an EU AA energy rating.

Financing: Through partners, the company provides the financing for end-customers and during the pre-assembly phase. This helps address the perception of risk that many owners have about new methods of construction.

Organization and mindset: The organization is built with an attitude that favors continuous improvement and innovation, and makes ongoing significant R&D investments.

Exhibit 47

Barcelona Housing Systems example



SOURCE: Barcelona Housing Systems; McKinsey Global Institute analysis

Box 22. Production system case study: Sustainable Living Innovations

Established in Seattle in 2008, Sustainable Living Innovations is applying a production system to create residential buildings. The company has designed a system of parts that are manufactured off-site using lessons learned from the Boeing production process. They can then be assembled rapidly on-site. The company's production system has a number of key characteristics:

- **Repeatable design and elements:** The company uses lightweight structural steel, which is standardized, widely available, inexpensive, and fast to assemble, resulting in buildings that weigh one-third as much as traditional concrete ones. It fits repeatable wall and floor panels onto the steel frame.
- **Prefabrication:** The panels are prefabricated off-site with plumbing and electrical included. Craft work on-site, confined purely to making the connections between panels, is reduced by 85 percent. The company also carries out quality control at the manufacturing facility and aspires to move to UL certification.¹
- **Supply chain:** The company sources components directly from the manufacturer rather than through a contractor. This ensures that the components and subassemblies meet its exact specification and can be fitted into the panels with no preparatory work such as trimming pipes to the right size.
- **Sustainability:** Sustainable energy and gray-water systems are incorporated within the panels. The buildings require an estimated 80 percent less energy and 50 percent less water than traditional buildings. Use of concrete has been minimized throughout the structure, which cuts down on CO₂ emissions.
- **Financing and risk:** The company has adopted a turnkey presale approach to address owner reservations and financing issues. It obtains the financing to build on a piece of land and sells the completed building to the owner once it is operational. It also addresses perceived risk by providing owners with “performance wraps”—ten-year warranties backed by insurance.
- **Cost:** The company estimates that its cost per square foot is 10 percent below the market rate, and it aims to reduce that by a further 25 percent through its latest design. Ultimately, the company believes that it can rival the low cost of wood-framed buildings.
- **Productivity:** The current design takes approximately half the time to build compared with traditional construction. Combined with the reduction in finishing work required on-site, a tenfold increase in productivity can be achieved, with the possibility of even more productivity gains through repetition.

¹ UL is an American safety consulting and certification company that provides safety-related certification, validation, testing, inspection, and auditing.

Box 23. Production system case study: Maison Laprise

This residential home builder based in Quebec, Canada, specializes in building modular prefabricated single-family homes. In 2013, Maison Laprise opened a manufacturing facility that prefabricates panels and modules with up to 90 percent of the work carried out in the facility. The company offers a fixed number of repeatable designs with several customization options. One of the big differences between Maison Laprise and other home builders is its clarity on price. The cost of each design is available online, and the website clearly specifies what each design includes. This is a big departure from the typical approach in the residential housing sector. Owners can choose to contract with Maison Laprise in a number of ways, from purchasing a modular home that the owner then assembles to a full turnkey service in which Maison Laprise constructs and assembles the solution.

Box 24. Production system case study: Broad Sustainable Buildings

This Chinese construction company specializes in developing prefabricated buildings. It has developed a construction process in which 90 percent of work is carried out in its factories, with the balance being on-site assembly. Repeatable designs and elements (such as a 3.9-by-15.6-meter panel with flooring, ceiling, and embedded shafts for ventilation, plumbing, electricity, and lighting) are used to simplify the structure and increase scale. Using these techniques, the company has built a 30-story hotel in 15 days. It estimates that costs were 10 to 30 percent lower than for a similar building constructed with traditional methods.

Box 25. Production system case study: Outotec

Outotec is a Finnish industrials company that provides modular solutions for small mines, metal-processing plants, renewable-energy production, and industrial water treatment. One of the solutions the company offers is the Outotec cPlant Flotation, a mobile flotation plant for small mines that is entirely modular and repeatable, with an element of customization through a range of bolt-on modules. Ninety-five percent of installation work and pre-commissioning can be done prior to delivery to site. The modules, which are pre-installed in steel frames the size of a shipping container and can be transported on regular trucks, are assembled on-site and require little civil engineering work. Outotec also has the ability to provide all engineering and installation services, which means that owners only have to contract with a single party. According to the company, the cPlant Flotation requires 20 percent less capital investment by the owner and requires 30 percent less labor compared with a conventional solution. And with the majority of the work carried out off-site, this solution is 30 percent faster to install than alternatives. In October 2016, Outotec signed a €10 million contract with Ma'aden, a Saudi Arabian mining company, for the delivery of a cPlant Flotation at Al Amar, demonstrating that there is demand for modular solutions in the industrial sector of the market.

A PRODUCTION SYSTEM APPROACH WOULD NEGATE MOST MARKET FAILURES AND ROOT CAUSES OF LOW PRODUCTIVITY

Any shift to a production system would negate the majority of market failures that we identified in Chapter 2, simplifying and streamlining the construction ecosystem and making it more efficient. A production system could address each of the ten root causes:

- **Increasing project and site complexities.** The level of work on-site would be significantly reduced in all cases through an increase in off-site prefabrication.
- **The construction industry is extensively regulated, land is fragmented, and the industry is highly dependent on cyclical public-sector demand.** Only the design and production processes, instead of entire projects, would be controlled and subject to approval. Quality control would be enhanced by taking place in the manageable environment of a factory.
- **Informality and the potential for corruption distort the market.** Transparency around products and pricing, and streamlined approvals processes, would squeeze informality and corruption.
- **Construction is opaque and highly fragmented horizontally and vertically.** In the production system, large players would consolidate or coordinate the fragmented supplier base to deliver the full range of components and work packages required for a project.
- **Contractual structures and incentives are misaligned.** In a production system, owners would buy from a palette of products that largely already exist and carry clear prices, reducing the need for complex contractual relationships.
- **Bespoke or suboptimal owner requirements.** Mass customization would replace bespoke solutions, radically simplifying the design process.
- **Design processes and investment are inadequate.** A limited selection of product options would hugely simplify and streamline the design process.
- **Poor project management and execution basics.** The fact that more components and packages are manufactured off-site would make on-site project management less complex, leaving players free to focus on managing their supply chains more effectively.
- **Insufficiently skilled labor at the frontline and supervisory levels.** Workers with low skill levels could be retrained and deployed in manufacturing facilities, where the complexity of the work would be lower.
- **Industry underinvests in digitization, innovation, and capital.** Large-scale players with large unit volumes could invest in technology and R&D. Disruption will play out differently across geographies and asset classes.

WHERE IS THE PRODUCTION SYSTEM LIKELY TO HAVE THE BIGGEST IMPACT?

Construction projects cover a broad spectrum in terms of their size and complexity, and change of different forms is possible along that spectrum (Exhibit 48). At one end are heavy construction projects that tend to be large, bespoke, and non-repeatable (notwithstanding repeatability of certain elements and modules). For these projects, acting in the seven areas discussed in Chapter 3 will help firms improve the effectiveness and productivity of the projects in which they engage. At the other end of the spectrum are fragmented trades and small residential projects. For them, technological disruption and changes in the competitive landscape may eventually lead to projects being part of a digital marketplace that bridges today's information gap between buyers, owners, sellers, construction firms, and tradespeople. Some of these players may be displaced by integrated production systems. In the middle of the spectrum are simple projects such as building single-family homes and more complex projects such as the construction of an airport. Here, there is potential to move toward a production system.

Exhibit 48

Construction in the middle of the project-scale spectrum can be dramatically different in a production system

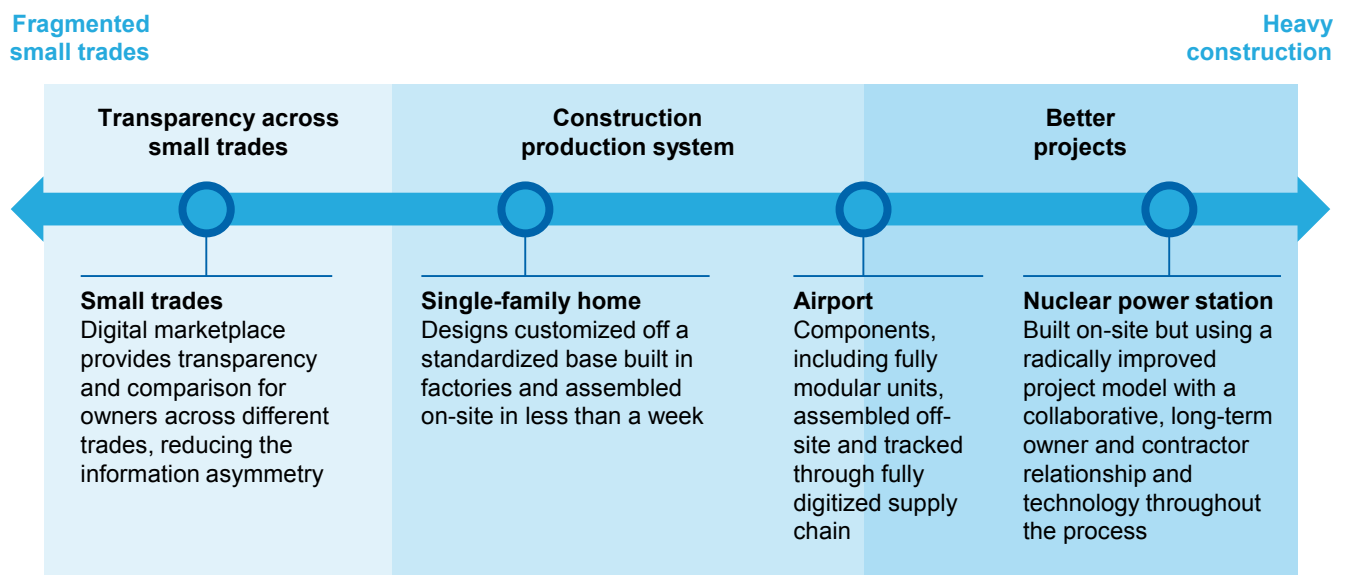

SOURCE: McKinsey Global Institute analysis

To demonstrate the different potential for productivity improvements, we can consider where on the spectrum the production system would be most suitable for immediate deployment. Both Barcelona Housing Systems and Sustainable Living Innovations have produced offerings that target the affordable housing segment of the construction market. There is a significant and growing gap in the requirement for, and provision of, affordable housing around the world that creates a strong demand pull to provide cost- and time-effective solutions that can be deployed in many locations. The buildings are of a large scale and are able to have a higher degree of standardization than would be acceptable in high-end residential projects. This supports the use of repeat designs and prefabrication off-site. Today, these projects are still just ahead of a tipping point; there are examples of small players who are moving close to having a full production system, but thus far no large player has brought scale to the equation.

Which segments could be next to feel the impact of a production system? As construction with mass-production characteristics becomes more established and sophisticated, there will be an increase in both demand and supply options that will widen the appeal of this type of approach. In a risk-averse industry, the impact of having an increasing number of projects using production-system methods actually built should not be underestimated. As these projects become more common, owners will be more willing to experiment and even begin to customize their offerings, in turn supporting growing and differentiated demand.

•••

The benefits of applying the levers discussed in Chapter 3 and a production system in this chapter are clear and may seem obvious. Nevertheless, the industry has been slow to change. In the next and final chapter, we discuss where the potential for disruption is greatest and describe some of the strategic dilemmas facing stakeholders.

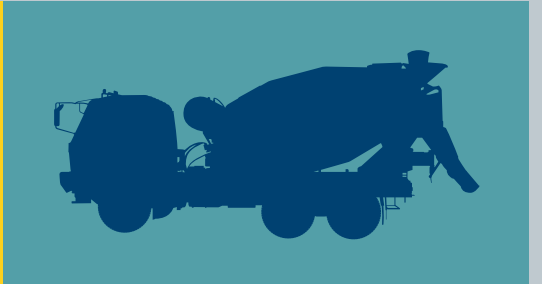
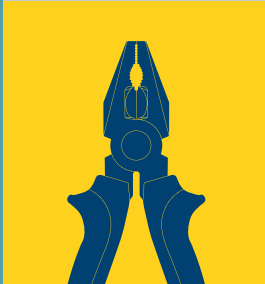
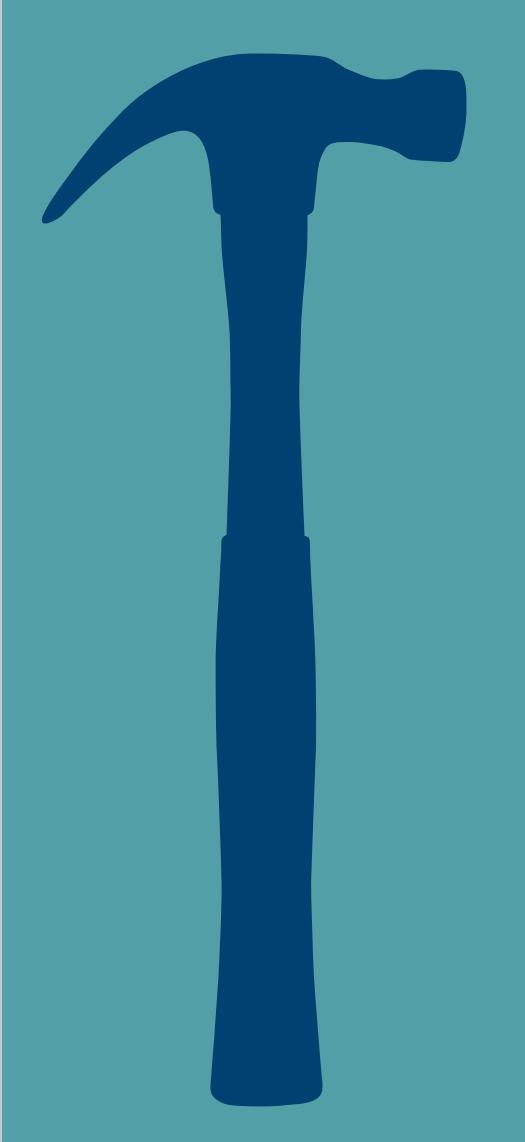
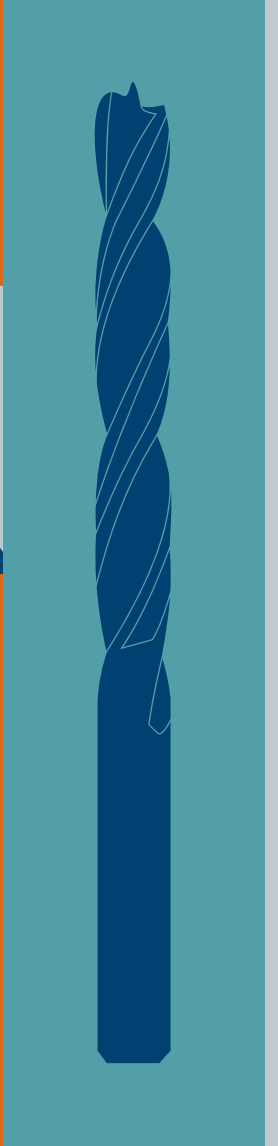
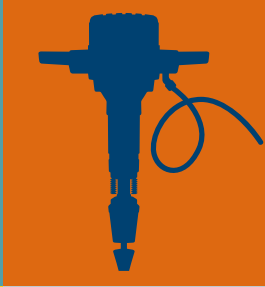



Beijing CBD construction site
© DuKai Photographer/Getty Images

5. WHERE AND HOW DISRUPTION MAY PLAY OUT

Acting in seven areas would significantly increase the productivity of construction; moving toward a mass-production system would be transformative to an entirely different degree for parts of the industry. But after decades of slow change, will the industry now take action to forge a higher-productivity future?

In this chapter, we look at the strategic choices that companies would have to make to increase their productivity, and why—currently—the status quo remains intact. We discuss four external trends that are increasing the pressure on all members of the industry to move away from the status quo, and discuss some of the key points that those in the industry should consider in a situation that may now be evolving after many years of stasis. It is difficult to say with confidence that change is definitely coming; nonetheless, industry participants should think strategically about the challenges ahead.

THE INDUSTRY IS CURRENTLY IN DEADLOCK

Today the industry is in deadlock. Many contractors stand to lose revenue and margin from moving to productivity-based competition unless owners and the broader industry environment move, too. Owners, in turn, need productive contractors they can trust and that provide them with choice, high quality, and low prices—at scale—before they can change procurement practices and build capabilities for a new paradigm.

Individual players face a critical strategic question—whether to continue with established business practices or push for change. Even if they opt for the latter, making change happen will require commitment from both owners and contractors (Exhibit 49).

Exhibit 49

Dramatic industry improvement will require owners and contractors to move together to new ways of working

Strategic game board

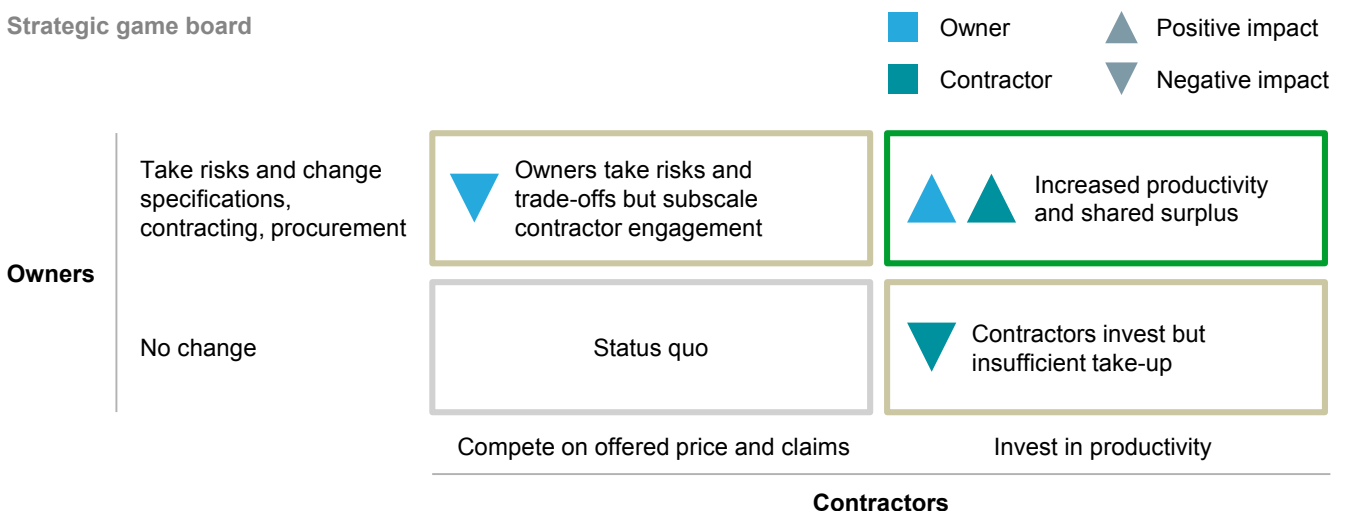

SOURCE: McKinsey Global Institute analysis

The biggest potential for disruption is likely to come from combinations of first-mover developers and contractors capturing the productivity surplus. Recent MGI and McKinsey findings on digitization demonstrated that companies that create a digital disturbance in their industry (or enter a new industry) will capture the largest surplus.⁹³ In order to enact a change in construction, however, current incentives, and disincentives, need to change.

Owners

Owners should be the main beneficiaries of a move to a more productive model that will eventually reward them with higher schedule reliability and lower costs. However, they are generally risk-averse and not sufficiently experienced to navigate an opaque market. Owners tend to have a bias for developing unique specifications and awarding contracts against those at lowest offered cost. Only when they have access to a range of contractors and production-system based players who can offer them more standardized products at lower price points—but still provide sufficient choice to meet their requirements—might they change their procurement practices. Most owners lack the scale to drive change in the market or to spur the development of standardized products and the transformation of the contractor landscape by themselves.

Owners in the public sector would have that scale in aggregate, but they typically act in a fragmented way in many subnational units and different agencies. Centralizing budgets and responsibility for construction would help, but there may well be resistance from government departments that currently have the responsibility for these functions.

Contractors and specialized trades

Many contractors and specialized trades profit from the current system and could lose from a move to a more efficient system. Some contractors have been successful in the current regime, which allows them to win orders by optimizing up-front pricing and then making up for lost surplus via change orders and claims, and where non-standard or costly specifications can mean higher revenue for them rather than lower margins. Currently, contractors are often more focused on maintaining those margins than on measuring and improving productivity.

A shift to productivity-based competition is only likely to be attractive if contractors can build the scale (and repeatability) needed to drive cost efficiencies from productivity gains that outweigh revenue losses from lower price points and fewer customer claims, and provide payback on up-front and ongoing investments in technology or skill building. For example, many contractors are reluctant to take the risk of investing in large off-site manufacturing facilities—which can easily cost \$20 million to \$30 million—without the assurance of a solid pipeline of sufficient volume of repeatable future work (Exhibit 50).

⁹³ Jacques Bughin, Laura LaBerge, and Anette Mellbye, “The case for digital reinvention,” *McKinsey Quarterly*, February 2017.

Exhibit 50

There is a trade-off between capital expense and improved labor productivity in industrial construction methods

ILLUSTRATIVE

○ Size of bubble indicates typical scale observed ● Benchmark: Traditional *in situ* ● Prefabricated ● *In situ*

Capital intensity

Capital expenditure per unit, \$

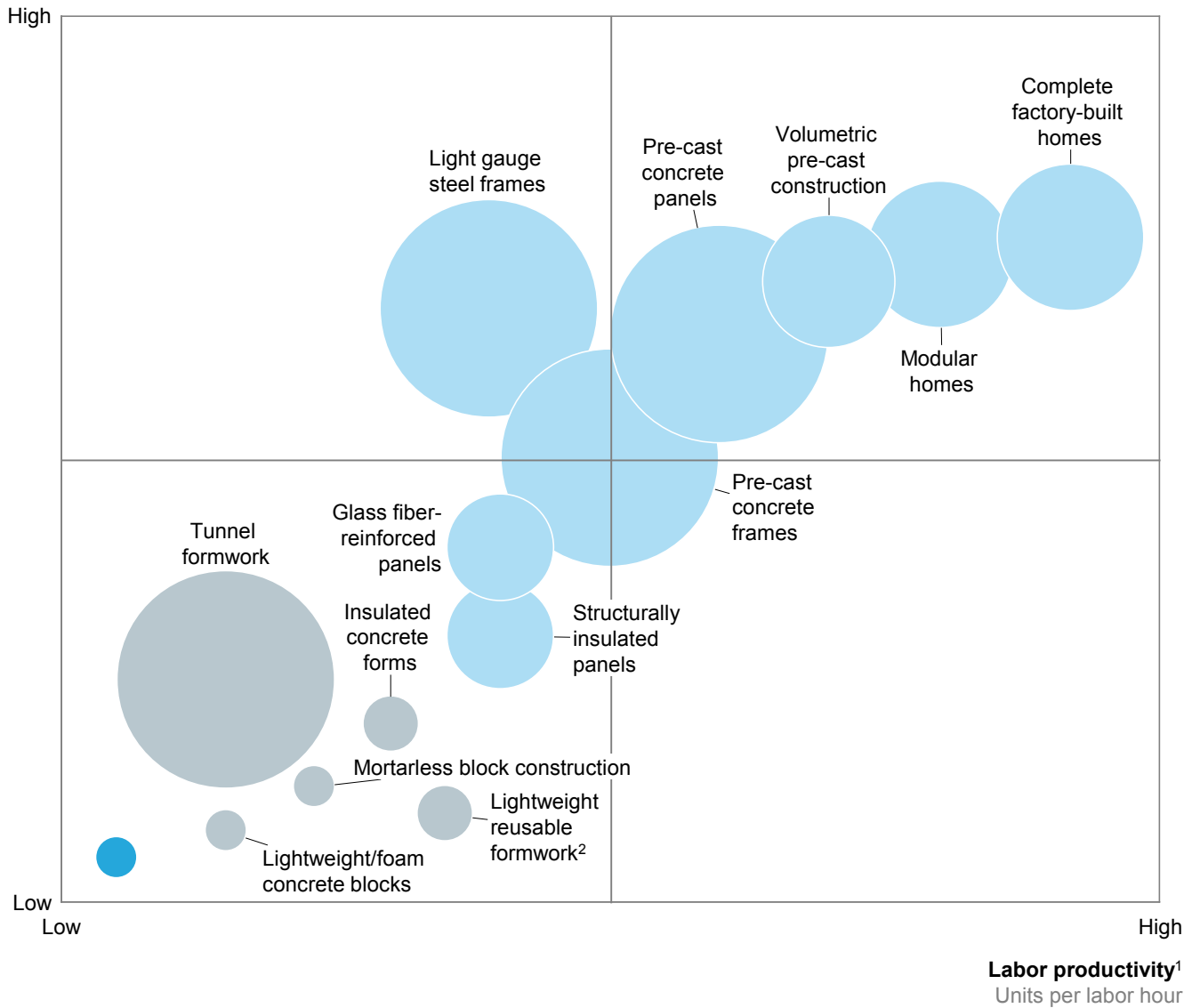

1 High labor productivity implies lower labor input needed for equal output; proxy for labor availability.
 2 For example, aluminum and plastic forms.

SOURCE: Expert interviews; McKinsey Global Institute analysis

Regulators

Regulators are also in a challenging position. They have to balance the need for increased productivity with sustainability, safety, and aesthetic requirements. They are liable to criticism when high standards are not met, but they receive little recognition for effective processes to enhance productivity. The benefits of improved productivity accrue to other parts of the government, namely those that own and run major projects. Alignment across government departments will be required to ensure that regulators are suitably incentivized to improve processes. An additional difficulty for regulators is that governments are typically accountable for the provision of low-skilled jobs and maintaining small businesses, and therefore efforts to improve productivity could be perceived as a downside for the regulatory bodies. However, this perceived trade-off is misleading. In fact, an increase in productivity allows low-skilled labor to deliver more much-needed infrastructure and housing at a lower cost.

However, we are beginning to see a move toward the simplification of permitting and other procedures, the standardization of building codes, the mandatory adoption of technologies such as BIM, and the consolidation of land markets (see Chapter 3 for more detail).

FOUR EXTERNAL TRENDS COULD DRIVE A PRODUCTIVITY TRANSFORMATION IN CONSTRUCTION

After decades of inertia in the sector, what kind of disruption could occur that would lead to higher productivity? Judging from the experience of other sectors, we observe four trends that increase the likelihood of a disruption and that have the potential to transform productivity where there is a positive response to that disruption. These trends could mean that the potential downside from not moving to a more productive model is more severe, and increase the potential upside for those who move quickly. We have already observed these trends play out in the retail sector (see Box 26, “How have these four trends affected the retail industry?”).

Construction players should watch out for:

- Rising requirements and demand in terms of volume, time, cost, quality, and sustainability
- Larger-scale players, more transparent markets, and disruptive new entrants
- More readily available new technologies, materials, and processes
- Rising wage rates and limits on migrant labor

Box 26. How have these four trends affected the retail industry?

There are many examples of other industries being affected by the trends which we detail in this section. To illustrate their impact we have selected examples of how they have affected the retail industry historically.

Rising demand: In Central and Eastern Europe, the opening up of economies after the fall of the Berlin Wall unleashed consumer demand. It attracted retail companies from Western Europe, such as Tesco, Carrefour, and Metro Group, which invested in expanding retail space at a rapid pace. They brought with them modern formats, which are estimated to be three times as productive as traditional retail outlets. In the Czech Republic, foreign-owned modern formats held 80 percent of the market in 2010. A similar story played out in Russia, where productivity increased from 15 percent of US retail sector productivity in 1999 to 31 percent of the US level in 2009.¹

Impact of larger-scale players: The impact of scale combined with aggressive new entrants and increasing transparency in an industry has been a major cause of disruption in other sectors, including retail, that has led to higher productivity. Walmart has been a major force for change in the industry using its status as the world's largest retailer to deal in high volumes, reduce suppliers' costs, price super-competitively, and invest in technology to transform its processes, distribution, and supply chains, creating more cost savings. The company pioneered the large-scale, big-box retail format and the strategy of expanding around central distribution centers, cutting costs and allowing it to pass on savings to consumers. Productivity in US retail jumped from 2 percent between 1987 and 1995 to 6.3 percent between 1995 and 1999—and more than half of that acceleration was due to Walmart.²

New technology: In 2013, MGI identified 12 disruptive technologies that will change the world. In retail, just think of how online retail is transforming the industry. The mobile Internet alone, MGI found, could save the retail industry \$7.2 trillion in costs, boosting productivity by between 6 and 15 percent in mobile and online retail compared with traditional retail. But technology-induced transformation is also on the horizon in more traditional parts of the sector. By enabling companies to manage stocks better, the research found, the Internet of Things could potentially deliver economic impact of as much as \$100 billion a year by 2025.³ Recent MGI research found that 53 percent of all retail-trade tasks could be automated, delivering very large cost savings and efficiency gains.

Rising wages: In response to the UK government's announcement of a new national living wage in 2015, the Centre for Retail Research predicted job losses in the industry but also a wave of new technology, including more self-service and self-scanning technology and more automation in warehouses—all of which have proved to boost productivity.⁴ The chairman of the John Lewis Partnership and head of the government's Productivity Leadership Group said in December 2016 that the introduction of a national living wage set at £7.20 an hour for those aged 25 or over could encourage more investment in automation and spur productivity.⁵

¹ For more, see *Urban world: Meeting the demographic challenge*, McKinsey Global Institute, October 2016, and *Lean Russia: The productivity of retail*, McKinsey Global Institute, April 2009.

² See Bradford C. Johnson, "Retail: The Wal-Mart effect," *McKinsey Quarterly*, 2002, and *US productivity growth, 1995–2000*, McKinsey Global Institute, October 2001. For another view, see Emek Basker, "The causes and consequences of Wal-Mart's growth," *Journal of Economic Perspectives*, volume 21, number 3, 2007.

³ *Disruptive technologies: Advances that will transform life, business, and the global economy*, McKinsey Global Institute, May 2013. Also see Stefan Niemeier, Andrea Zocchi, and Marco Catena, *Reshaping retail: Why technology is transforming the industry and how to win in the new consumer driven world*, John Wiley, 2013.

⁴ J.A.N. Bamfield, *What does the government's living wage mean for UK retail?* Centre for Retail Research, 2015.

⁵ Graham Ruddick, "John Lewis boss: Higher minimum wage should boost productivity," *The Guardian*, December 25, 2016.

Rising requirements and demand in terms of volume, time, cost, quality, and sustainability

Demand for construction is growing in quantitative and qualitative terms for a number of reasons, and it is vital that what is built delivers greater productivity if only to meet demand. There are a number of factors changing demand and requirements:

- **Continuing urbanization in developing economies with large-scale greenfield needs.** In developed countries including the United States and economies in Western Europe, urbanization is plateauing at around 80 to 85 percent of the population. However, in China, the population living in cities could expand from around 560 million in 2005 to about 950 million in 2025—an increase larger than the entire US population today. Only around one-third of India’s population currently lives in cities. Africa is at a relatively early stage of urbanization, and an additional 187 million Africans are expected to live in cities over the next decade.⁹⁴ As city populations continue to expand, demand for housing, transportation, and utilities will be strong. For cities that are still growing, making those investments ahead of demand is crucial if they are not to run into stresses that create diseconomies of scale. The construction industry needs to improve its productivity, speed, and cost to deliver against this housing and infrastructure need.⁹⁵ Greenfield expansion on a large scale is particularly amenable to modern, productive methods of construction. Large-scale housing programs, for instance, support the use of standardized pre-cast production. Vast infrastructure programs, for example rail in China, support the emergence of mass-produced high-speed rail infrastructure.
- **A widening infrastructure-finance gap.** McKinsey estimates that \$3.3 trillion of investment in economic infrastructure will be needed globally to 2030 to support economic growth. But on the current trajectory, investment will fall short by about 0.4 percent of global GDP.⁹⁶ There is a \$1 trillion-a-year opportunity to deliver infrastructure more productively—more than enough to close the gap.
- **Pressing need for affordable urban housing.** An estimated 36 million new housing units will be required in the 20 largest cities alone by 2025; 75 percent of them will be in Asia. In addition to simply keeping pace with future demand for housing in general, in 2014 there were an estimated 330 million urban households living in substandard housing or stretched financially by housing costs; by 2025, this number is projected to rise to 440 million.⁹⁷ This scale of demand and the required price points can best be delivered in production system approaches. Large-scale housing programs, for instance, support the use of standardized pre-cast product.
- **Higher sustainability requirements.** Increasing sustainability requirements further support a shift to pre-production. Global growth in green and sustainable building construction has been forecast to average 22.8 percent per year between 2012 and 2017.⁹⁸ This increased demand means that the construction industry will have to rethink how it designs and builds projects to increase focus on waste reduction, abatement of carbon emissions, and sustainability. These sustainability requirements can be more easily met with lighter-weight construction materials that have good thermal properties in

⁹⁴ For more, see *Urban world: Meeting the demographic challenge*, McKinsey Global Institute, October 2016.

⁹⁵ For extensive discussion on this point, see *Infrastructure productivity: How to save \$1 trillion a year*, McKinsey Global Institute, January 2013.

⁹⁶ From 2016 through 2030, the world needs to invest about 3.8 percent of GDP, or an average of \$3.3 trillion a year, in economic infrastructure simply to support expected rates of growth. Emerging economies account for some 60 percent of that need. But if the current trajectory of underinvestment continues, the world will fall short by roughly 11 percent, or \$350 billion a year. The size of the gap triples if we consider the additional investment required to meet the new UN Sustainable Development Goals. See *Bridging global infrastructure gaps*, McKinsey Global Institute and McKinsey’s Capital Projects & Infrastructure Practice, June 2016.

⁹⁷ *A blueprint for addressing the global affordable housing challenge*, McKinsey Global Institute, October 2014.

⁹⁸ *Industrial strategy: Government and industry in partnership*, Construction 2025, HM Government, July 2013.

a production system in which the complexity of, say, additional brown-water piping and solar energy cells can be handled during the mass production of panels.

Larger-scale players, more transparent markets, and disruptive new entrants

There have been construction players of global scale—which we define as having revenue of more than \$1 billion outside of their home market—in the sector for some time, mostly in developed markets. But the number of such players is rapidly expanding, mostly in emerging economies (Exhibit 51). Of these emerging market players, one-fifth come from China. Large Chinese firms have been rapidly internationalizing, in the process acquiring construction companies in local markets, executing megaprojects often as part of government-to-government packages, and aggressively participating in large-scale bids. Similarly, players from India are prominent in the Middle East, executing projects across asset classes with a delivery model supported by low-cost labor imported from South Asia.

In addition to larger scale, new entrants and increased market transparency through online platforms, for instance, have the power to trigger disruption. Platforms that provide more information about relative costs and track records of different suppliers will enable owners to better understand the trade-offs that they are making when they procure projects.

Exhibit 51

Large emerging market competitors, especially Chinese firms, are capturing an increasing share of construction revenue

Global contractors with \$1 billion+ international revenue
 % of companies by type of economy¹ in award year

■ Developed ■ Emerging ■ China

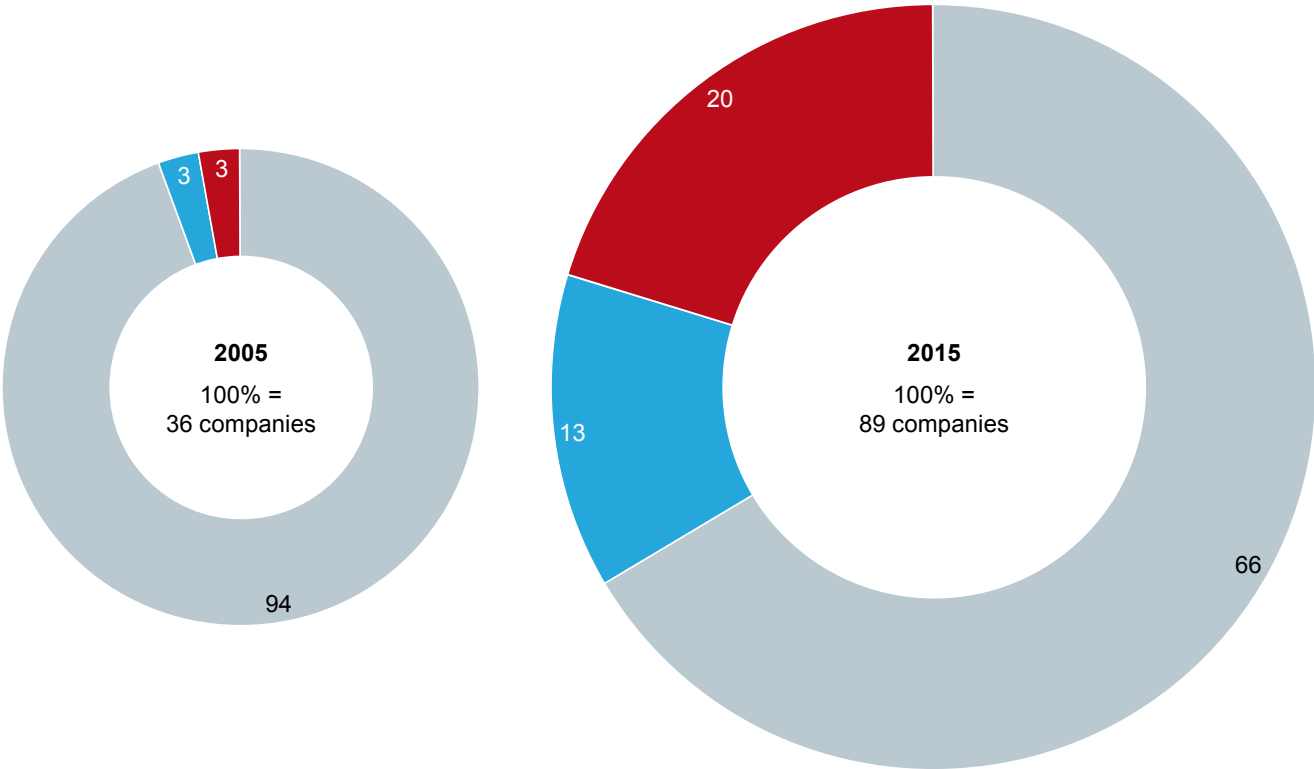

¹ Developed or emerging, as classified by IMF.

SOURCE: ENR Sourcebooks; McKinsey Global Institute analysis

More readily available new technologies, materials, and processes

Globally, innovation is coming to construction. Venture-capital investment has recently been pouring into modern construction methods and digital technologies for use in the sector (Exhibit 52). Beyond tools that can immediately help make the industry more productive, such as better project management software, a particularly interesting development is investment in, and the rise of, digital marketplaces—online platforms that match owners and contractors buying materials and services with contractors and suppliers that can provide them. Such marketplaces can help raise transparency and thus address one of the root causes of low productivity growth in the sector head-on. An example of this is the rise of e-auctions—negotiations conducted via a web-based online platform that enables real-time interaction with suppliers, and creates a transparent and efficient way of negotiating while ensuring confidentiality. It would be unwise to believe that only small players generate disruption—attackers are bearing down on both sides. In April 2016, Oracle, the multinational computer technology firm, bought Textura, a leading provider of construction contract and payment-management cloud services. IronPlanet, an online marketplace for used heavy construction equipment, sold for \$760 million in August 2016.⁹⁹

Exhibit 52

Venture-capital funding is helping to boost penetration of modern construction methods and the use of digital technologies at scale

Year-over-year funding in construction tech, 2008–15

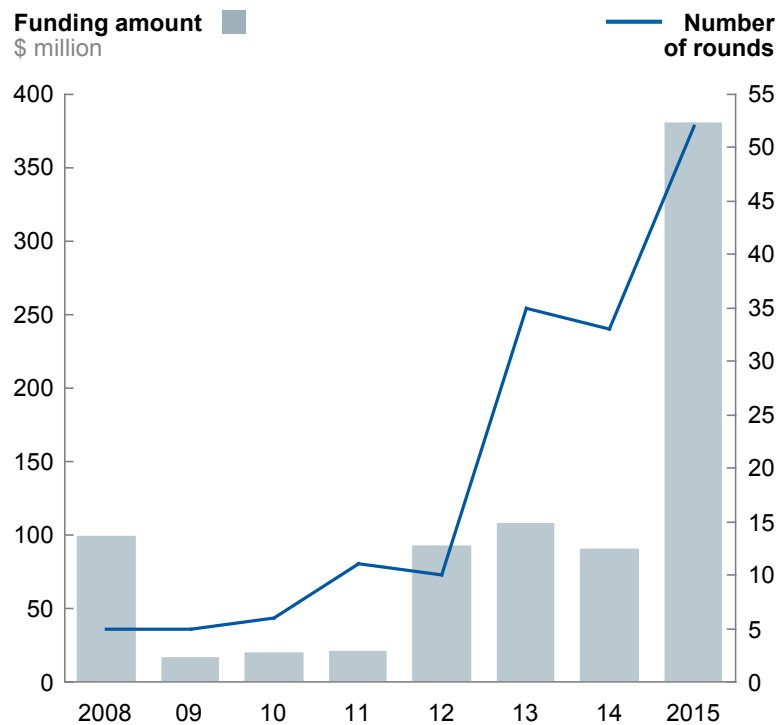

Funding amount \$ million

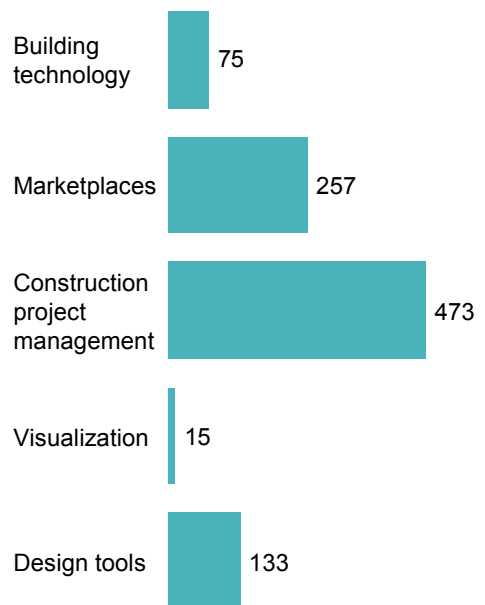

SOURCE: *Tracxn Report: Construction Tech*, February 2016; McKinsey Global Institute analysis

⁹⁹ Ritchie Bros. Auctioneers.

Rising wage rates and limits on migrant labor

Rising wages and increasing numbers of firms moving from informal to formal construction are also potentially powerful catalysts for higher productivity in the sector. In other industries, higher labor costs have led to a wave of innovation—a pattern that played out after the oil-price shock in the 1970s—because they force companies not only to look for efficiencies so that they do more with fewer people but also to innovate through reorganization and improved materials and equipment. Wage rates in construction are under upward pressure in many parts of the world (Exhibit 53).

Exhibit 53

Construction wage rates (skilled and unskilled) have seen upward pressures in many geographies

Top 10 countries (and United States) with largest percentage point difference

% change in consumer price index (CPI) and construction hourly labor rates (local currency), 2008–16

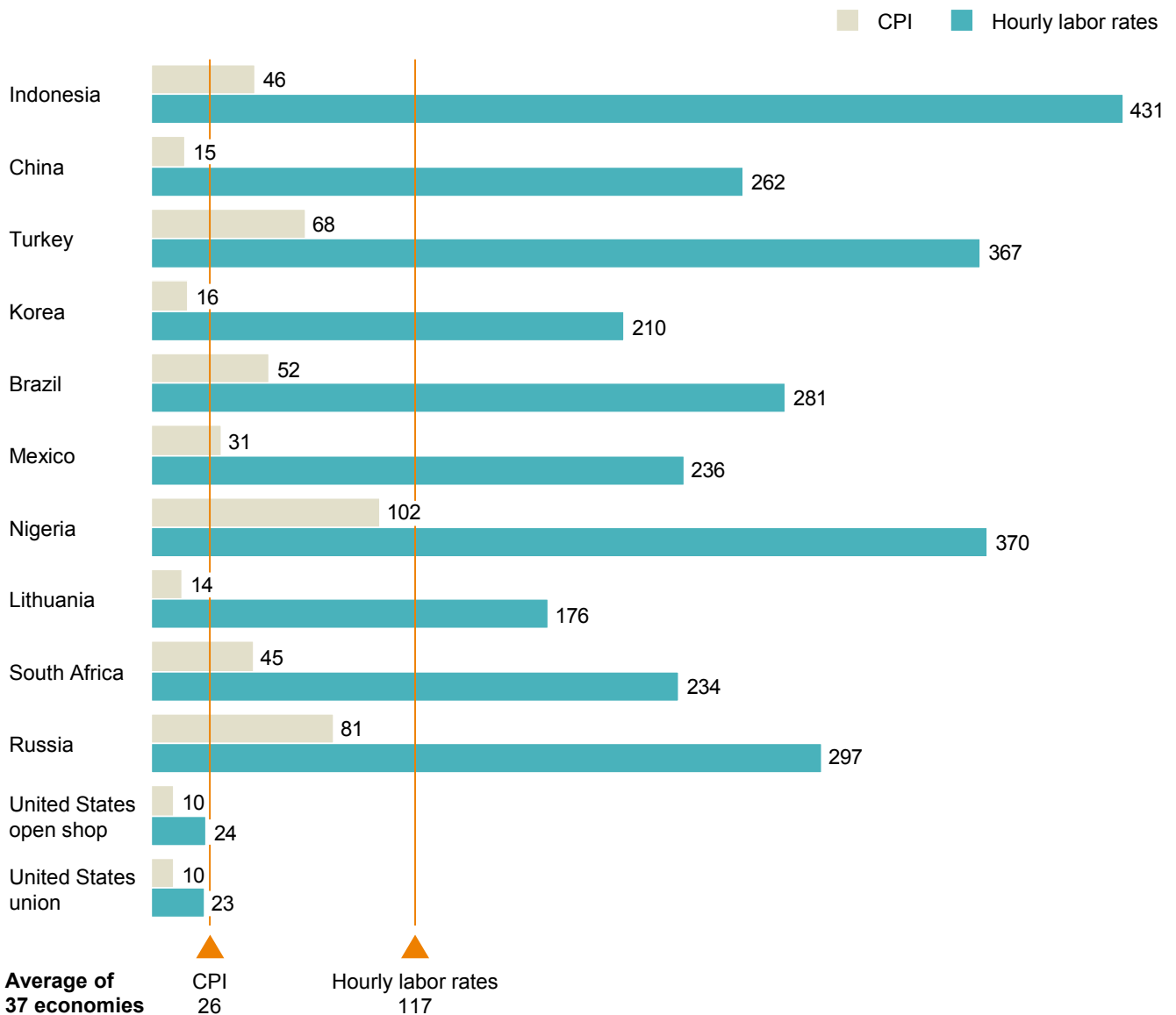

SOURCE: Compass International; McKinsey Global Institute analysis

A number of factors are pushing wages higher, including rapid GDP growth in some economies, restrictions on the amount of migrant labor, and scarcity of construction workers:

- Rapid economic growth of over 7 percent a year in China over the past decade has resulted in a 262 percent increase between 2008 and 2016 in the wages of unskilled construction workers in local currency. An effort to change labor conditions also seems evident in the high number of strikes in recent years across the country. The number of strikes more than doubled from 1,379 in 2014 to 2,774 in 2015, and 36 percent of the strikes in 2015 were in the construction industry—the biggest concentration of strikes of any sector.
- In Singapore, the government has introduced a manpower levy on foreign workers and set a quota on the number of foreign work permits. These measures were primarily taken to incentivize the use of technology and increase the regional competitiveness of Singaporean companies rather than to encourage the use of local labor.
- Following the 2008 financial crisis, an estimated 19.8 percent of jobs in the construction industry in the United States were lost.¹⁰⁰ These semiskilled workers moved into other jobs as other parts of the economy recovered more quickly, which left the construction sector with a shortage of workers when activity picked up again. This pattern led to wage increases in construction of 24 percent, or 2.5 times the consumer price index, after 2008.

THE MATURITY OF TRENDS HAS VARIED FROM COUNTRY TO COUNTRY, WITH DIFFERENTIAL IMPACT ON PRODUCTIVITY

The impact of the maturity of the trends that we have discussed varies in the construction sector. We have analyzed the trends in a selection of countries based on a series of quantitative and qualitative indicators of how mature each trend is in each country (see the technical appendix for more detail). The group of countries we chose to analyze include the largest country from the declining leaders and laggards categories defined in Chapter 1, and at least two from the categories that are showing promising increases in productivity, accelerators, and overperformers (Exhibit 54). Each of the countries is analyzed in more detail in the case studies throughout this report.

Of the four trends that we have discussed, demand historically has driven the largest boosts in productivity. This was the case in Australia, which experienced a mining boom between 2003 and 2012, when the United States expanded its highway network after World War II, and in Belgium today where demand for offshore wind farms and dredging is booming. This suggests that the biggest boosts in construction productivity are more likely to be in developing markets where demand will be stronger. Our analysis has shown that over the long term, countries' productivity has followed an S-curve with respect to GDP. This demonstrates why developing countries have an increase in productivity as demand grows.

Countries in which we see a number of trends occurring are also the countries where productivity levels, productivity growth, or both have been comparatively high. This country comparison shows that just one trend may be enough to explain high productivity growth if the trend is strong enough and other conditions aren't impeding it, but, in many cases, it may not be sufficient. For example, in Brazil, where productivity levels and growth have been low, pressure from high demand for construction due to rapid urbanization, a large affordable housing gap, and other deficiencies in strategic infrastructure have been insufficient to drive change. None of the other conditions have been met, and some of the root causes identified in Chapter 2 are particularly significant. In Belgium, technology

¹⁰⁰ US Bureau of Labor Statistics, Current Employment Statistics survey.

adoption (especially off-site prefabrication) seems to have been the main productivity driver, likely influenced by other factors such as high wages. In Singapore, the government has affected the overall industry dynamics and therefore each of the trends with a set of policies directed at improving productivity.

Exhibit 54

The maturity of four trends varies among countries

		Impact of driver						
		China	Australia	Belgium	Singapore	United Kingdom	United States	Brazil
Trends leading to a potential disruption	Rising requirements and demand in terms of volume/time, cost, and quality/sustainability	High	High	Medium	High	Medium	Medium	High
	Larger-scale players in more transparent markets and disruptive new entrants	High	Medium	Medium	High	Medium	Low	Low
	New technologies, materials, and processes	Medium	Medium	High	High	Medium	Medium	Low
	Rising wage rates, labor shortages, and limitations to migrant labor	Medium	High	Medium	Medium	Medium	Medium	Medium
Government response	Shifts in the regulatory landscape in terms of harmonization and performance orientation	Medium	High	Medium	High	High	Medium	Low
Annual construction productivity growth, 1995–2015		6.71	2.05	1.96	1.37	0.49	-1.04	-1.21
		%						

SOURCE: McKinsey Global Institute analysis

HOW CAN DIFFERENT PLAYERS BREAK THE DEADLOCK AND PUSH TOWARD HIGHER PRODUCTIVITY?

The four trends that we have discussed are likely to increase pressure on the industry to change. The potential for change will also be defined by the regulatory environment that supports it. To support productivity growth, regulators can:

- Create transparency on cost across the construction industry and publish performance data on contractors.** In the United Kingdom, the government published cost data on the construction industry between 2012 and 2015. This exercise in cost transparency has delivered more than £3 billion in efficiency savings and, as the Cabinet Office put it, “started a process of change in the relationship between government and the construction industry by making government a more informed and better coordinated client.”¹⁰¹
- Mandate the use of BIM to build transparency and collaboration across the industry.** In the United States, the General Services Administration mandated in 2006 that new buildings designed through its Public Buildings Service use BIM. If BIM were mandated for all public-sector projects, use of this technology would spread to all other types of projects.
- Reshape regulations to support productivity.** We have discussed at length the scope for regulation to make a difference in construction productivity, whether through action

¹⁰¹ *Government construction: Construction cost reductions, cost benchmarks and cost reduction trajectories to March 2015*, Cabinet Office, UK Government, July 20, 2015.

to reduce land fragmentation, as Japan and India have done, or through harmonizing codes, as we are seeing in the EU.

- **Consider labor interventions to ensure development of skills instead of a low-cost transient migrant workforce.** The government of India has set up a new Ministry of Skill Development and Entrepreneurship and has a flagship outcome-based skills training program called PMKVY (Pradhan Mantri Kaushal Vikas Yojana). PMKVY has a skills certification and reward program that aims to mobilize a large number of young Indians to undertake training and become employable. In support of this initiative, the government then introduced a skills training program for construction workers and undertaken many initiatives to develop a skilled labor force for the construction industry.¹⁰²

If industry players perceive their sector to be amenable to disruption, they need to take account not only of the trends creating that potential disruption but also the regulatory environment. Contractors can:

- **Introduce a new operating system.** Construction companies can strive for a step change in predictability, productivity, and performance by introducing new management systems, technical systems, and shifting mindsets and behaviors. Doing so should lead to performance being treated as a core essential—as safety is today—and achieve clear and collaborative transparency across the project and among stakeholders.
- **Invest in technology.** While technology is an important part of the operating system, it is worth highlighting as a separate issue. As noted in Chapter 2, the construction industry is one of the least digitized sectors in the world, and there is the potential for the same productivity impact from heavier use of technology as we have observed in other industries. 5D BIM is a powerful tool to ensure transparency among stakeholders and to track progress on-site, and contractors should consider deploying it where it can be used effectively in collaboration with other parties on a project. Similarly, the development of automation equipment has the potential to revolutionize certain repeatable tasks on construction sites.
- **Develop a strategic approach.** Construction companies can re-evaluate their business models, which have often been based on a project-to-project approach without the development of long-term strategies. Companies should consider longer-term investments that would enable them to be at the forefront of any disruption. They could, for instance, invest in a production system, or partner with a player from outside the construction industry to change the dynamics of their own sector.

¹⁰² “Skill development for construction workers,” *BuildoTech*, February 15, 2016.

Owners of every type can drive change, but those in the public sector have the most scale to drive the biggest impact:

- **Combine projects into portfolios of work and pipelines of projects to drive cost savings and build scale.** For instance, the Swedish Transport Administration (Trafikverket) was founded in April 2010 with the aim of increasing the productivity of infrastructure construction by 10 to 15 percent in the first three to five years and 2 to 3 percent annually thereafter. The organization plans across transport modes, linking individual projects to socioeconomic benefits and the best utilization of resources. Its project portfolio is linked to a three-year budget cycle and ten-year infrastructure plans. It supports and involves itself directly in the delivery of projects, including engaging contractors and running procurement programs. It closely measures and tracks productivity.
- **Move away from bespoke design for each project.** Harmonization of design—with obvious needs for a degree of customization—can encourage repeatability where it is justified by the trade-offs. An example of this is the standardized bridges used on the Chinese high-speed railroad construction project noted in Chapter 4.

...

Change may not be a distant prospect—there are signs of potential disruption in many parts of the global construction industry. The diagnostic is well known. Best practices already exist. The new potential of a mass-production system offers the chance for a dramatic step change in productivity in parts of the industry. But the question remains whether the various players in the sector, which have different incentives and challenges, will indeed leave behind the status quo and embrace change that will lead to higher productivity. Many are already doing so; many others will need to follow if the global construction sector is to end decades of inertia and transform itself as other industries have done.



CASE STUDY: CHINA

Productivity and demand trends. Construction productivity has grown significantly over the past 30 years, reflecting strong demand growth. Demand is being propelled by a combination of continuing urbanization (encouraged by government policies) and rising incomes, leading to higher expectations among consumers for their homes and offices. Around 700 large cities in China alone will account for \$7 trillion, or 30 percent, of global urban consumption growth to 2030. The share of demolitions and rebuilds is expected to rise from around 25 percent of demand now to 30 to 40 percent in the 2020s; the share of less productive renovation work is expected to rise from 10 percent to 40 percent.

Government interventions and regulatory setup. Private companies carry out most construction, but projects are largely funded through government banks. The government shapes the sector through broad policy initiatives such as encouraging urban living, gradual strengthening of environmental standards, and the use of public-private partnerships. In October 2016, the Ministry of Finance stipulated that all new waste and wastewater treatment projects should use public-private partnerships. Private investment rose from a 22 percent

share of construction investment in 2012 to 26 percent in 2014. The government has encouraged the use of EPC contracts and the adoption of BIM by requiring that they be used in public projects. It aims to ensure that more than 30 percent of future construction uses pre-cast buildings, and is also studying taxation policies and how to streamline project approvals.

Technology investments. In the 1980s and 1990s, China could rely on an abundance of highly motivated and cheap workers from rural areas, but now wages are rising at a time when the construction labor force is shrinking due to demographic trends and fewer young people wanting a career in the sector. One report found that 90 percent of construction workers in Shenzhen were aged over 50. This is likely to act as an incentive for further automation of the sector, which is already high in large infrastructure projects such as bridge and road building. There is some use of modularization, and large developers and EPC contractors, in particular, are investing in developing the use of BIM. Chinese companies are also pioneering new technologies; for example, WinSun Construction built a six-story apartment building using a 3D printer in 2015.¹

Productivity evolution, 1995–2010
Gross value added¹ per hour worked
Index: 100 = 1995

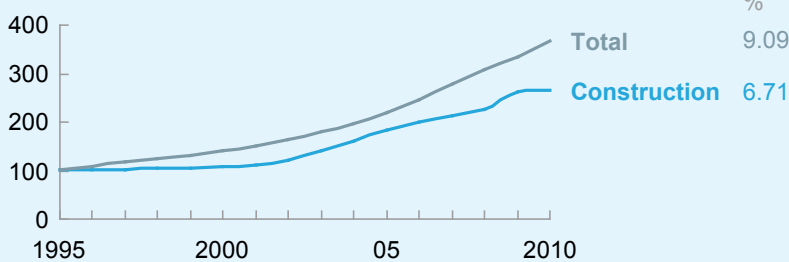

Compound annual growth rate
%

Total 9.09
Construction 6.71

Sector size and composition
2015 \$ billion

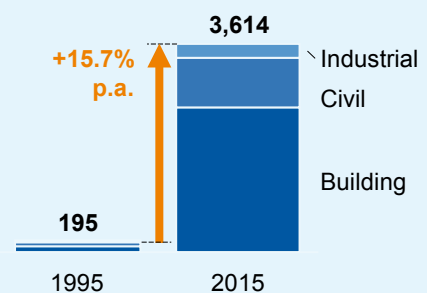

\$3 per hour

2010 construction productivity level

\$3 per hour

2010 average economy productivity level

\$36.1 billion

Annual value lost¹ to low productivity

¹ 2005 USD, non-PPP adjusted

SOURCE: IHS Global; OECD; World KLEMS; IHS; ITF; GWI; World Energy Outlook; Asian Development Bank; China national accounts; McKinsey Global Institute analysis

¹ *Urban world: The global consumers to watch*, McKinsey Global Institute, March 2016; *Preparing for China's urban billion*, McKinsey Global Institute, March 2009; "Interpretation of the policy of guiding opinions on major efforts to developing assembled buildings," press release, State Council Information Office of the People's Republic of China, October 2016; Da Zhong Small, *A summary of policies supporting residential real estate industrialization in China*, www.new-ci.com, July 2016; Yuanchao Xu, "Water PPPs to lead in China," *China Water Risk*, November 16, 2016; "China's ageing construction workers and the urgent need for an industry overhaul," *China Labour Bulletin*, March 30, 2015; "Why private capital is optimistic towards China infrastructure," *People's Daily*, May 25, 2016.



CASE STUDY: SINGAPORE

Productivity and demand trends. Construction has historically had low productivity. A concerted effort by the government to tackle this issue in the mid-2000s led to an increase in on-site productivity of 1.4 percent a year between 2009 and October 2016—2 percent a year over the past three years. The government aims to raise this to between 2 and 3 percent annually between now and 2020. The potential for even higher productivity remains large, as there is scope for many construction sites to adopt more modern construction tools and methods, rely less on low-wage workers, and improve the skills of middle management.

Government interventions and regulatory setup. There have been four key categories of government efforts: demand and supply of migrant labor; mandating the use of technology and investing in R&D; encouraging the capability building of the workforce; and offering financial incentives for productivity improvements. On the first, it introduced a manpower levy on foreign workers that has progressively increased up to \$950 per foreign worker depending on skill level, and set a quota limiting the number of foreign work permits to seven per full-time local employee. On the second, a 2010 program was launched to promote labor-efficient building design, including a target for 80 percent of the industry to use BIM by 2015. The Building and Construction Authority (BCA) has also allocated 785 million Singapore dollars for a Construction Productivity and Capability Fund to support skills and capability development and technology

adoption. Singapore has also put in place the world's first BIM electronic submission system, contributing to the third thrust of policy by streamlining regulatory submission. Singapore is also adopting outcome-based regulation including, for instance, in the use of CLT and Ghulam. Furthermore, the government has rolled out a Productivity Gateway Framework—a structured approach developed to help government procurers to achieve a 25 to 30 percent productivity improvement from the 2010 level for all new projects. This initiative means that productivity considerations are included in up-front planning and there is new focus on greater adoption of productive technologies.

Technology investments. Singapore launched a second program in 2015 to promote technology and off-siting. It aims to step up the long-term adoption of 35 technologies in seven R&D clusters, including design for manufacturing and assembly, automated equipment and robotics, digital and information-communications technology, BIM, virtual design and construction, 3D printing, advanced construction materials, and productive civil engineering solutions. Singapore is strongly encouraging prefabrication, modularization, and automation. A global first is the development of multi-storey integrated construction and prefabrication hubs equipped with advanced automation. The world's tallest 40-storey pre-finished modular concrete condominium is now being built, reducing manpower by up to 40 percent.¹

Productivity evolution, 2001–14

Gross value added¹ per hour worked
Index: 100 = 2001

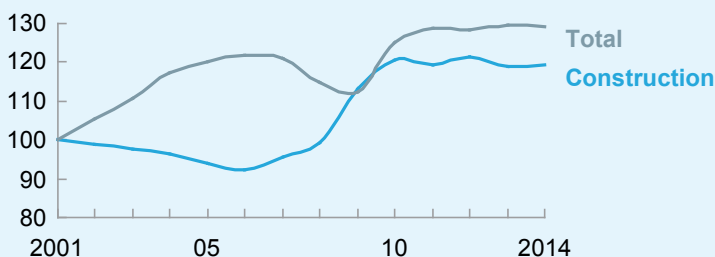

Compound annual growth rate %

Total 2.00
Construction 1.37

Sector size and composition

2015 \$ billion

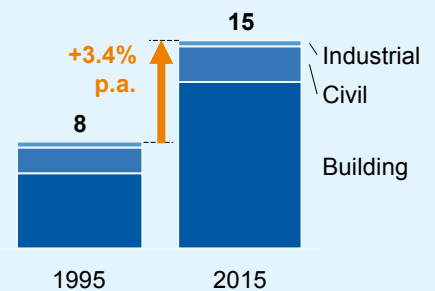

\$11 per hour

2014 construction productivity level

\$33 per hour

2014 average economy productivity level

\$15.0 billion

Annual value lost¹ to low productivity

¹ 2005 USD, non-PPP adjusted

SOURCE: Singapore Department of Statistics; OECD; World KLEMS; IHS; ITF; GWI; World Energy Outlook; World Bank; Asian Development Bank; Singapore national accounts; McKinsey Global Institute analysis

¹ "New measures for developers to drive construction productivity improvements," BCA press release, March 10, 2014; "BCA adds wow factor to industry with 3D experimental technology," BCA press release, December 21, 2015; *Briefing on revised PQMV2 framework and the 2nd construction productivity roadmap*, November 17, 2015; Singapore Housing and Development Board.



Low angle view of people working at construction site
© Chincheng Wang/EyeEm/Getty Images

TECHNICAL APPENDIX

This appendix outlines key elements of the methodology used in the report, along with the major data sources and assumptions adopted in the following sections:

1. Productivity definitions and measurement issues
2. Productivity data sources
3. Construction market sizing
4. Sizing the global productivity-growth gap
5. MGI Construction Productivity Survey
6. Opportunity sizing for improvement levers
7. Heat-map indicators

1. PRODUCTIVITY DEFINITIONS AND MEASUREMENT ISSUES

In its purest form, productivity can be described as the output achieved by a given amount of input. This report examines productivity by applying that basic premise at three analytical levels: macroeconomic (country), financial (firm), and operational (project). The report focuses on labor as the key input.

Measuring labor productivity

At the macroeconomic level, we use gross value added—the final value of the construction good (for example, the house) minus the value of the inputs required to build that house (for instance, wood and bricks) excluding depreciation of capital goods. We define inputs as the amount of labor in hours or the number of persons engaged. Together, these metrics describe gross value added per hour worked or per person engaged, a measure of how efficiently a worker transforms inputs to outputs. It is a widely computed metric of labor productivity used consistently by economists.

Construction at the macroeconomic level includes work done within a country's borders performed by companies or sites self-classifying as performing construction activities. Notably, prefabricated components are counted only if they are fabricated by a construction company as classified in a country's national accounts; for example, prefabricated homes would typically be part of construction, while production of windows including frames would not.

Wherever possible, we report construction labor productivity in real, price-adjusted, constant-currency terms. These metrics adjust prices of inputs (raw materials) and outputs (finished structures) for inflation with a sector-specific double-sided deflator that removes price fluctuations within a country (for instance, the boom in house prices in the United States in 2005, or the recent volatility in energy input prices). We typically report subsector data in nominal terms due to a lack of sufficiently granular and differentiated deflators. Various measures of purchasing power parity that we investigated for construction seemed incongruent and not very robust, so we chose to not adjust for different price levels among countries.

At the firm level, we define output as revenue and calculate value added as either revenue minus the cost of purchased inputs, or—equivalently—as earnings before interest, taxation, depreciation, and amortization (EBITDA) plus labor costs. We then calculate productivity by dividing value added by the number of employees.

Finally, output from projects is much more tangible. Here, output is the amount of a physical task completed, such as tons of steel erected, linear feet of piping installed, or cubic yards of concrete poured. Project-level input remains number of hours worked. While it is difficult to directly connect project-level metrics with more abstract economic yardsticks, physical measures of productivity are often most top-of-mind among on-site employees.

Measurement challenges

The lack of reliable measures of purchasing power parity and subsector deflators mentioned above are just two of several limitations inherent in available economic data.¹⁰³ While attempting to correct for these limitations is beyond the scope of this report, we do wish to acknowledge and call the reader's attention to the following issues:

- Official statistics do not tabulate migrant or undocumented workers. While these laborers do contribute to the measurable final output, their exclusion artificially inflates official productivity statistics in countries with non-negligible levels of informal labor.
- The amount and frequency of off-site prefabrication is increasing. When off-site prefabrication is undertaken by a manufacturer, such as a supplier of heating, ventilation, and air-conditioning systems, official statistics attribute that productivity to the manufacturing sector, potentially reallocating productivity increases there. When prefabrication is performed by a construction company, productivity gains accrue to the construction sector. Similarly, construction activities carried out by manufacturing companies, such as installation of an elevator by a manufacturer, are typically not counted.
- Shifts among segments within construction—or changes in the construction mix—from inherently higher-productivity to lower-productivity subsectors like repair work (and vice versa) may obfuscate the true growth patterns of productivity on a like-for-like basis.
- Quality improvements in final output may not be captured accurately by the value-added measure and deflators; for instance, price comparisons might look at the typical price for constructing a single-family house without taking into account the increased value produced by, for example, higher fire-safety standards or new lifestyle norms such as the prevalence of central air-conditioning.

Relationship between productivity and profitability

Because construction is a labor-intensive industry, labor (direct and indirect) makes up 30 to 50 percent of a firm's cost structure. Solutions to improve productivity will affect a large component of cost. Therefore, the direction and magnitude of change for both cost and productivity will initially be highly correlated. But there can be several exceptions:

- **Investment requirements.** When productivity improvements require substantial operating expenditure on new technology, more design time, or higher-cost materials, the relationship becomes less clear.
- **Customer prices.** Whether or not higher productivity correlates with higher profitability depends on the impact on price structures. For instance, if productivity increases

¹⁰³ For an overview of measurement deficiencies, see Bernard Vogl and Mohamed Abdel-Wahab, "Measuring the construction industry's productivity performance: Critique of international productivity comparisons at industry level," *Journal of Construction Engineering and Management*, volume 141, issue 4, April 2015.

are achieved at the industry rather than at the firm level, this may lead to intensified competition, resulting in much of the productivity gain being passed on to customers in the form of lower prices rather than higher firm profitability. In contrast, low-productivity projects with ample change orders and claims can be quite profitable if contract structures allow firms to pass these costs on to customers.

- **Labor cost.** Historically, there has been a strong correlation between productivity growth and wage growth—workers capture a share of productivity increases. This relationship has weakened in recent years, however, and has been weaker in construction than in some other sectors.

2. PRODUCTIVITY DATA SOURCES

We measured the construction productivity performance of 39 countries representing each global region, and compared that performance with both the total economic productivity and manufacturing productivity performance in each country in absolute and growth terms.

We used the Organisation for Economic Co-operation and Development (OECD)'s Structural Analysis database's Productivity and Unit Labor Cost by Main Economic Activity ISIC Rev. 4 for the real productivity growth rates of OECD member countries, comparing sector "F" construction, sector "C" manufacturing, and sectors "A_U" total economy. We used the World Input-Output Database (WIOD), which was last published in 2013, for absolute productivity levels for most of the world's major economies in Western Europe and the United States. This database relies on the same classification scheme (ISIC Rev. 4) as the OECD. For information on productivity growth rates and levels for less developed countries (primarily in Africa, Latin America, and Asia), we used the GGDC-10 database published by the Groningen Growth and Development Centre in 2010. If a country's data were not published in one of these three harmonized databases, we used data from that country's national statistics authority.

To calculate productivity levels for each sector, we divided value added by hours worked by persons employed. Where hours worked data were not available, we used the number of employees instead, and multiplied by hours worked per week data available from the United Nations International Labour Organization. We then deflated value added to 2005 levels with sector-specific, double-sided value-added deflators. The reason for this approach was that some countries published data only in real 2005 values and did not provide associated deflators.

We made every attempt to provide data for the longest possible time series in each country. Where growth rates were available for more years than absolute data, we extrapolated absolute productivity levels from the last available year of absolute data forward and/or backward using available growth rates.

Due to a lack of available sector-specific, double-sided figures for purchasing power parity, we did not attempt price-level adjustments among countries. To convert data denominated in national currencies to US dollars, we used average yearly 2005 exchange rates from oanda.com, to match the base year of the analysis.

3. CONSTRUCTION MARKET SIZING

We derived the size of the construction sector, as well as its split into asset classes, and projections from McKinsey's proprietary Infrastructure Stock and Spend model. This model draws on data from IHS, the International Transport Forum, Global Water Intelligence, and national statistics offices, as well as projection methodologies developed by MGI.

We used typical ratios of the value of structures to GDP from the US Bureau of Economic Analysis (BEA) to derive sensitivities of construction output with GDP growth rates.

4. SIZING THE GLOBAL PRODUCTIVITY-GROWTH GAP

To size indexed global productivity growth, we calculated an average growth rate for all countries in our data set weighted according to a country's share of global construction output.

To size the productivity gap for 2015, we assumed for each individual country that productivity levels rose to either the total economy or manufacturing sector level, respectively. If the productivity level of the construction sector in a country was above the total economy and/or manufacturing level, we calculated this as a "negative gap" but assigned that country a gap of zero.

With the higher assumed productivity, we then calculated how many labor hours would be saved in achieving the same amount of construction value added. We then assumed that the excess labor would be re-employed at the average total economy productivity rate to calculate the additional value added that would accrue to the economy.

5. MGI CONSTRUCTION PRODUCTIVITY SURVEY

The MGI Construction Productivity Survey was distributed to around 5,000 industry professionals in August 2016. Responses were received from September 2016 representing asset owners, engineering and construction firms, suppliers, other institutions such as construction consulting firms, academics, and industry associations including the Construction Industry Institute. We received responses from companies working in all regions. We did not select participants randomly, but rather distributed the list to our network of industry contacts as well as through professional conferences and bodies in which we participated. This approach leads to various biases in responses, including to large companies, and to the United States specifically and to the developed world more broadly. In total, we received 144 completed and 91 partially completed surveys. We asked participants to rank the relative importance of root causes of low productivity, provide their level of agreement on the extent to which their company implements best practices on each solution, and their company's current adoption level of technology. We also asked respondents whether they planned to adopt a new technology within the next three years (if they had not already done so) and what they saw as the largest barriers to adoption of new technology.

We tabulated the results of the ranking in importance of root causes from both completed and partial surveys (provided the partial survey response ranked all root causes) and tabulated the results for all other questions only from surveys that were fully completed.

6. OPPORTUNITY SIZING FOR IMPROVEMENT LEVERS

We sized the impact of the seven solutions described in this report first by considering the productivity impact in terms of hours saved on a single project, assuming that the lever was pulled fully. We also estimated the impact on cost using the same methodology. We used relevant case studies from previous McKinsey client work, together with expert interviews and literature reviews, to develop estimates of the impact at the project level.

We then multiplied these estimates by our assumptions on incremental adoption rate opportunities over the next 15 years. We determined incremental adoption rates by comparing the percentage of project values that could theoretically adopt the best practices under each lever by 2030 with adoption rates today. We estimated potential adoption rates based on expert interviews, and adoption rates today from responses to MGI's Construction Productivity Survey, McKinsey's experience in working with capital projects, and expert interviews.

This approach provides an estimate of the impact on sector-level productivity globally by 2030. We adjusted the impact values in all three steps of this analysis by individual asset class (building, civil, industrial) and economy type (emerging, developed) to accurately reflect the global mix of construction.

Most of the benefits of a change in the regulatory landscape will be seen in how this supports the implementation of the six other levers, for instance how outcome-based regulation enables the use of new materials or how land pooling enables repeatability and standardization. For this reason, we have not quantified the impact of regulation separately.

For each of the six other levers, we have estimated potential impact, applicability, and the current adoption rate, indicating how the total figures were calculated (Exhibit A1).

Exhibit A1

Sizing logic and assumptions

■ Building ■ Civil ■ Industrial

			Project impact			Applicability			Current adoption			Total improvement	
			Project-level cost/productivity impact			Portion of all projects that could apply solution by 2030			Portion of all projects already using this solution			Productivity	Cost
Rewire the contractual framework	Deve- loped markets	Produc- tivity	15	20	20	75	75	75	35	20	20	8-9	6-7
		Cost	10	15	30								
	Emerging markets	Produc- tivity	15	20	20	60	50	50	15	5	5		
		Cost	10	12	30								
Rethink design and engineering processes	Deve- loped markets	Produc- tivity	20	20	30	70	50	60	30	25	30	7-10	7-10
		Cost	20	20	20								
	Emerging markets	Produc- tivity	20	20	30	70	50	60	20	10	10		
		Cost	20	20	25								
Improve procurement and supply-chain management	Deve- loped markets	Produc- tivity	20	25	25	60	50	50	25	20	20	7-8	3-5
		Cost	10	10	13								
	Emerging markets	Produc- tivity	20	25	25	50	40	40	15	10	10		
		Cost	20	10	13								
Improve on-site execution	Deve- loped markets	Produc- tivity	20	15	25	60	70	70	35	30	30	6-10	4-5
		Cost	12	10	10								
	Emerging markets	Produc- tivity	25	25	35	50	60	60	20	15	15		
		Cost	6	15	15								
Infuse digital technology, new materials, and advanced automation	Deve- loped markets	Produc- tivity	65	75	80	40	50	50	25	25	25	14-15	4-6
		Cost	20	30	30								
	Emerging markets	Produc- tivity	60	70	80	25	40	50	10	10	25		
		Cost	15	25	30								
Reskill the workforce	Deve- loped markets	Produc- tivity	10	15	15	70	80	80	20	20	20	5-7	4-6
		Cost	5	15	15								
	Emerging markets	Produc- tivity	10	15	15	40	50	50	10	10	10		
		Cost	5	15	15								

SOURCE: McKinsey Global Institute analysis

7. HEAT-MAP INDICATORS

The “heat map” that shows the susceptibility of a number of countries’ construction sectors to disruption—Exhibit 54 in Chapter 5—drew on both qualitative information from external literature and interviews with experts, as well as a number of quantitative indicators. A country was coded green, orange, or red on each of the four trends of potential disruption and the government measures taken to facilitate productivity growth.

- **Rising requirements and demand in terms of volume, time, cost, quality, and sustainability.** A country is coded green if at least two conditions are met, orange if one is met, and red if none is met: urban household growth from 2010 to 2015 of more than 1 percent;¹⁰⁴ affordable housing gap as a percentage of GDP of more than 1 percent;¹⁰⁵ and government regulations including high sustainability and quality measures (qualitative judgment).
- **Larger-scale players, transparent markets, and disruptive new entrants.** A country is coded green if at least two conditions are met, orange if one is met, and red if none is met: market share of biggest five construction companies of more than 20 percent;¹⁰⁶ share of megaprojects (more than \$1 billion value) of more than 50 percent;¹⁰⁷ and government or public sector is a large player as a consolidated owner (qualitative).
- **New technologies, materials, and processes.** This is based on qualitative judgment based on expert interviews (see country case studies).
- **Rising wage rates, labor shortages, and limitations to migrant labor.** A country is coded green if at least two conditions are met, orange if one is met, and red if none is met: construction wage rate increase of more than 30 percent since 2008 in local currency;¹⁰⁸ mentions of severe labor shortages in industry reports or expert interviews; and existence of government policy imposing strict restrictions on migrant labor.
- **Government response.** A country is coded green, orange, or red depending on the prevalence of best-practice government actions, including streamlining the permit approval process, introducing outcome-based regulation, using best-value tendering processes, creating cost transparency across the industry, mandating use of technology, promoting innovation, and investing in capability building. The color is based largely on qualitative judgement in addition to the World Bank’s ease of doing business index for dealing with construction permits. A country is more likely to be coded green if it is ranked in the top 15 percent (out of 190 countries) and red if it is ranked in the bottom 15 percent. The World Bank considers the number of procedures, the number of agencies/players involved, and the average time to get a construction permit.

¹⁰⁴ MGI Cityscope database version 2.2.

¹⁰⁵ MGI Affordable Housing database and MGI Cityscope database version 2.2.

¹⁰⁶ Capital IQ; Trends Top for Belgium; Brazilian Chamber of the Construction Industry and O Empreiteiro annual report 2015 for Brazil; EMIS and the Ministry of Trade and Investment for Singapore.

¹⁰⁷ Infrastructure Projects Analytics Tool (IPAT), McKinsey & Company.

¹⁰⁸ Compass International Global Construction Costs Yearbook 2008 and 2016.

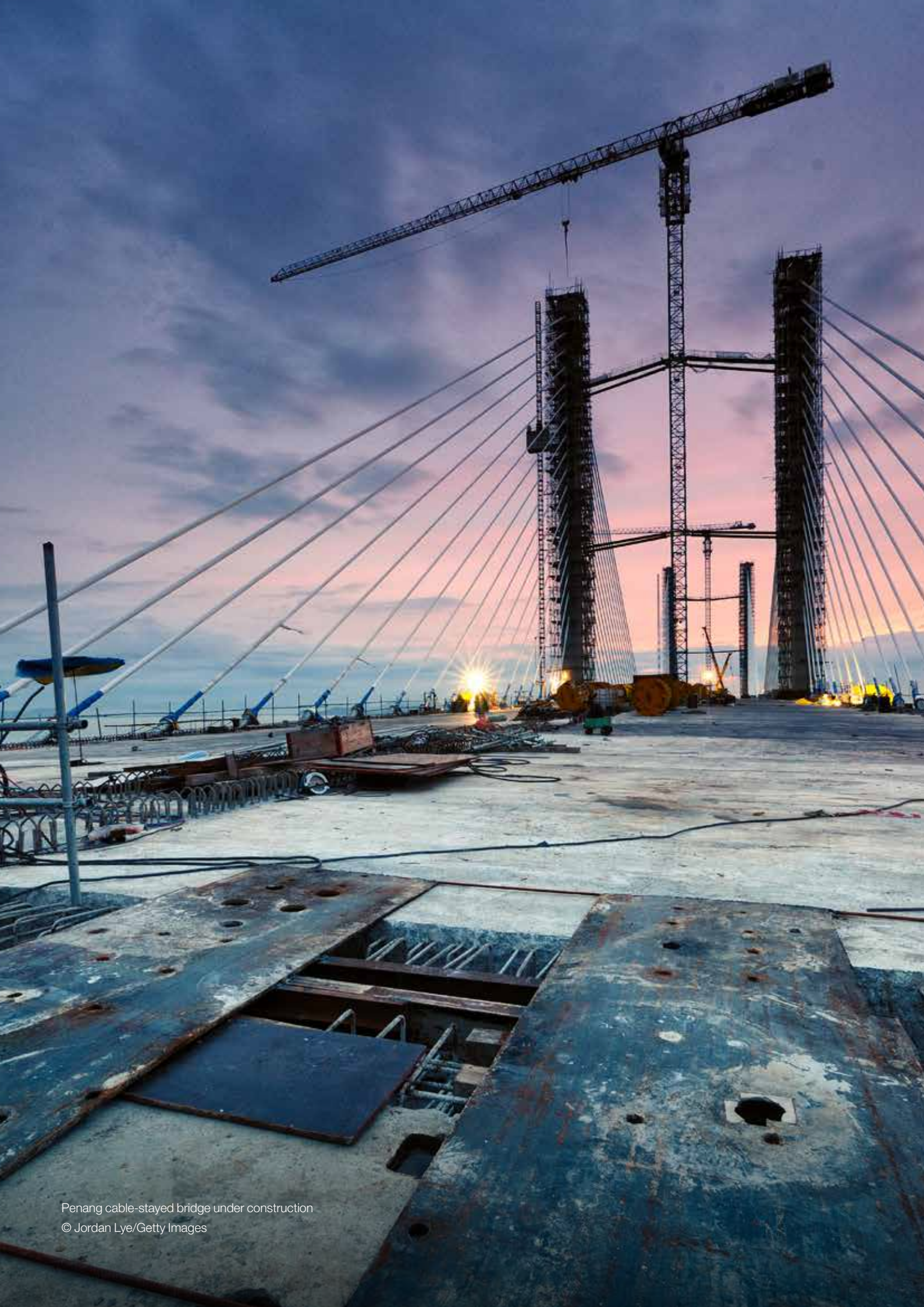

Penang cable-stayed bridge under construction
© Jordan Lye/Getty Images

BIBLIOGRAPHY

A

Allen Consulting Group, *Performance of PPPs and traditional procurement in Australia: Final report for Infrastructure Partnerships Australia*, November 30, 2007.

Australian Government Productivity Commission, *Public infrastructure: Inquiry report*, July 14, 2014.

Automotive Manufacturing Training and Education Collective, *AMTEC curriculum, certification, and assessments*, 2011.

B

Ballaney, Shirley, *The town planning mechanism in Gujarat, India*, World Bank Institute, 2008.

Ballard, Glenn, Gregory Howell, and Michael Casten, *PARC: A case study*, Proceedings of the Fourth Annual Conference of the International Group for Lean Construction (IGLC-4), Birmingham, United Kingdom, 1997.

Bamfield, J.A.N., *What does the government's living wage mean for UK retail?* Centre for Retail Research, 2015.

Basker, Emek, "The causes and consequences of Wal-Mart's growth," *Journal of Economic Perspectives*, volume 21, number 3, 2007.

Berman, Jay, and Janet Pflieger, "Which industries are sensitive to business cycles?" *Monthly Labor Review*, US Bureau of Labor Statistics, February 1997.

Best, Rick, "International comparisons of cost and productivity in construction: A bad example," *Australasian Journal of Construction Economics and Building*, volume 12, number 3, 2012.

Bigam, Georgina, and Nathan Pascutto, *Addressing skills gaps through direct intervention (TUCA)*, Tunnelling and Underground Construction Academy case study, September 27, 2016.

Bjerager, Peter, *Performance-based safety regulation*, National Academy of Sciences, April 15, 2016.

Bughin, Jacques, Laura LaBerge, and Anette Mellbye, "The case for digital reinvention," *McKinsey Quarterly*, February 2017.

BuildoTech, "Skill development for construction workers," February 15, 2016.

Burleson, Rebecca C., *An analysis of multiskilled labor strategies in construction*, Construction Industry Institute, June 1998.

C

Cabinet Office, UK Government, *Government construction: Construction cost reductions, cost benchmarks and cost reduction trajectories to March 2015*, July 20, 2015.

Castro-Lacouture, Daniel, L. Sebastian Bryson, Christopher Maynard, Robert L. Williams II, and Paul Bosscher, *Concrete paving productivity improvement using a multi-task autonomous robot*, Proceedings of the 24th International Symposium on Automation & Robotics in Construction, 2007.

Center for Construction Research and Training, Labor Occupational Health Program, University of California, Berkeley, *Immigrant workers in U.S. construction: Sharing lessons learned in our unions*, 2010.

China Labour Bulletin, "China's ageing construction workers and the urgent need for an industry overhaul," March 30, 2015.

Confédération Construction, *Investir dans la construction (Investing in construction)*, annual report 2011–12, 2012.

D

Department for Business, Energy and Industrial Strategy and Department for Communities and Local Government, *Construction labour market in the UK: Farmer review*, October 17, 2016.

E

EMIS, *Construction sector Brazil*, June 2015.

F

Fukuyama, Francis, "Too much law and too little infrastructure," *The American Interest*, volume 12, number 3, November 8, 2016.

G

Gerovski, Paul, Stephen Machin, and John van Reenan, "The profitability of innovating firms," *The Rand Journal of Economics*, volume 24, number 2, 1993.

Government construction strategy: 2016–2020, Cabinet Office and Infrastructure and Projects Authority policy paper, March 23, 2016.

H

Hackney, John W., and Kenneth King Humphreys, *Control and management of capital projects*, McGraw-Hill, 1991.

Hauer, Daniel J., *Modern management applied to construction*, McGraw-Hill, 1918.

HM Government, *Industrial strategy: Government and industry in partnership, Construction 2025*, July 2013.

HM Treasury, *A new approach to public private partnerships*, December 2012.

Hodson, Hal, "Spider drones weave high-rise structures out of cables," *New Scientist*, November 6, 2013.

J

JLL, *US construction trends and outlook*, Q3, 2016.

Johnson, Bradford C., "Retail: The Wal-Mart effect," *McKinsey Quarterly*, 2002.

K

Koebel, C. T., "Innovation in home building and the future of housing," *Journal of the American Planning Association*, volume 74, number 1, 2008.

Konami, Hirohide, "Japanese efforts to supply low cost housing," presented at 42nd East Asia Regional Organization for Planning and Housing Regional Conference in Ulaanbaatar, Mongolia, September 24, 2009.

L

LeanIn.org and McKinsey & Company, *Women in the workplace*, September 2015.

Ling, F. Yng, X. Leow, and K. Lee, "Strategies for attracting more construction-trained graduates to take professional jobs in the construction industry," *Journal of Professional Issues in Engineering Education and Practice*, volume 142, issue 1, January 2016.

Liu, Min, Glenn Ballard, and William Ibbs, "Work flow variation and labor productivity: Case study," *Journal of Management in Engineering*, volume 27, issue 4, October 2011.

Loosemore, Martin, "Improving construction productivity: A subcontractor's perspective," *Engineering, Construction and Architectural Management*, volume 21, issue 3, 2014.

M

Manufacturing Institute, *Manufacturing's multiplier effect is stronger than other sectors'*, 2016.

Marley, Frances, *Exploring the impact of the ageing population on the workforce and built environment*, Chartered Institute of Building, 2015.

McGraw Hill Construction SmartMarket Report, *Prefabrication and modularization: Increasing productivity in the construction industry*, 2011.

McKinsey & Company, *How digital innovation can improve mining productivity*, November 2015.

McKinsey & Company, *Imagining construction's digital future*, June 2016.

McKinsey & Company, *Women Matter 2012: Making the breakthrough*, March 2012.

McKinsey Center for Government, *Education to employment: Designing a system that works*, January 2013.

McKinsey Global Institute, *A blueprint for addressing the global affordable housing challenge*, October 2014.

McKinsey Global Institute, *Beyond Korean style: Shaping a new growth formula*, April 2013.

McKinsey Global Institute, *China's choice: Capturing the \$5 trillion productivity opportunity*, June 2016.

McKinsey Global Institute, *Digital America: A tale of the haves and have-mores*, December 2015.

McKinsey Global Institute, *Disruptive technologies: Advances that will transform life, business, and the global economy*, May 2013.

McKinsey Global Institute, *How to compete and grow: A sector guide to policy*, March 2010.

McKinsey Global Institute, *India's path from poverty to empowerment*, February 2014.

McKinsey Global Institute, *Infrastructure productivity: How to save \$1 trillion a year*, January 2013.

McKinsey Global Institute, *Lean Russia: The productivity of retail*, April 2009.

McKinsey Global Institute, *The power of parity: How advancing women's equality can add \$12 trillion to global growth*, September 2015.

McKinsey Global Institute, *Preparing for China's urban billion*, March 2009.

McKinsey Global Institute, *A tool kit to close California's housing gap: 3.5 million homes by 2025*, October 2016.

McKinsey Global Institute, *Urban world: The global consumers to watch*, March 2016.

McKinsey Global Institute, *Urban world: Meeting the demographic challenge*, October 2016.

McKinsey Global Institute, *US productivity growth, 1995–2000*, October 2001.

McKinsey Global Institute and McKinsey's Capital Projects & Infrastructure Practice, *Bridging global infrastructure gaps*, June 2016.

Meacham, Brian J., ed., *Performance-based building regulatory systems: Principles and experiences, A report of the Inter-Jurisdictional Regulatory Collaboration Committee, IRCC*, February 2010.

Menches, C. L., J. Chen, and K. A. Hull, *Factors that differentiate reimbursable contracting from lump sum contracting*, Construction Industry Institute research report 260-11, 2012.

Merrrow, Edward W., *Industrial megaprojects: Concepts, strategies, and practices for success*, Wiley, 2011.

N

Ng, Jacky Y. K., and Alan H. S. Chan, "The ageing construction workforce in Hong Kong: A review," *Proceedings of the International MultiConference of Engineers and Computer Scientists 2015*, volume II, IMECS 2015, Hong Kong, March 18–20, 2015.

Ng, Thomas W. H., and Daniel C. Feldman, "Evaluating six common stereotypes about older workers with meta-analytical data," *Journal of Personnel Psychology*, November 1, 2012.

Niemeier, Stefan, Andrea Zocchi, and Marco Catena, *Reshaping retail: Why technology is transforming the industry and how to win in the new consumer driven world*, John Wiley, 2013.

O

Ollivier, Gerald, Jitendra Sondhi, and Nanyan Zhou, *High-speed railways in China: A look at construction costs*, China Transport topics number 9, World Bank, July 2014.

OECD, *OECD foreign bribery report: An analysis of the crime of bribery of foreign public officials*, December 2, 2014.

P

Passell, Jeffrey S., and D'Vera Cohn, *Share of unauthorized immigrant workers in production, construction jobs falls since 2007*, Pew Research Center, March 26, 2015.

Patterson, Daryl, *Completed 10-storey apartment in Australia: Forte from an owner/development perspective*, Woodworks and Lend Lease, November 6, 2014.

People's Daily, "Why private capital is optimistic towards China infrastructure," May 25, 2016.

Prefabrication and modularization: Increasing productivity in the construction industry, McGraw Hill Construction SmartMarket Report, 2011.

S

Singapore Building and Construction Authority, *Briefing on revised PQMV2 framework and the 2nd construction productivity roadmap*, November 17, 2015.

Slater, John, and Nick Cater, *Constructing a better future: Restoring order and competition in the building industry*, Menzies Research Centre, 2016.

Small, Da Zhong, *A summary of policies supporting residential real estate industrialization in China*, www.new-ci.com, July 2016.

Statistics Belgium Expert Group on Competitiveness and Employment, *Arbeidskosten, loonsubsidies, arbeidsproductiviteit, en opleidingsinspanningen van de ondernemingen (Labor costs, wage subsidies, labor productivity, and training efforts by enterprises)*, July 2013.

Streule, Thomas, Nino Miserini, Olin Bartolomé, Michael Klippel, and Borja García de Soto, "Implementation of scrum in the construction industry," presented at the Creative Construction Conference in Budapest, June 25–28, 2016.

Sveikauskas, Leo, Samuel Rowe, James Mildenberger, Jennifer Price, and Arthur Young, "Productivity growth in construction," *Journal of Construction Engineering and Management*, volume 142, issue 10, October 2016.

T

Taylor, Frederick Winslow, *The principles of scientific management*, Harper & Brothers, 1911.

Thomas, Willis H., *The basics of project evaluation and lessons learned*, second edition, CRC Press, August 22, 2014.

Tracxn, *Tracxn report: Construction tech*, February 2016.

U

UN-Habitat, *Going green: A handbook of sustainable housing practices in developing countries*, 2012.

UN-Habitat, *Scaling-up affordable housing supply in Brazil*, 2013.

United Kingdom—England, *PPP Units and institutional framework*, European PPP Expertise Centre, June 2012.

V

Vogl, Bernard, and Mohamed Abdel-Wahab, "Measuring the construction industry's productivity performance: Critique of international productivity comparisons at industry level," *Journal of Construction Engineering and Management*, volume 141, issue 4, April 2015.

W

Waters, L. B., P. P. Smith, and C. A. Prescott, "Leveraging lessons learned across multiple deepwater projects," paper presented at the Offshore Technology Conference in Houston, Texas, May 1–4, 2006.

White House Office of the Press Secretary, *Factsheet: Investing more than \$50 million through ApprenticeshipUSA to expand proven pathways into the middle class*, October 2016.

X

Xu, Yuanchao, "Water PPPs to lead in China," *China Water Risk*, November 16, 2016.

Y

Yearbook Australia, Industry Information Unit, Competitiveness Division, Department of Industry, Science and Resources, Australia, *The construction industry's linkages with the economy*, 2002.

RELATED MGI AND MCKINSEY RESEARCH



Getting big mining projects right: Lessons from (and for) the industry (February 2017)

More than four out of five mining projects come in late and over budget, by an average of 43 percent. Intelligent interventions can improve the odds of success—particularly on distressed projects.



Imagining construction's digital future (June 2016)

There is a massive incentive for players in the construction industry to identify solutions to transform productivity and project delivery through new technologies and improved practices. There are five ways that the industry can transform itself over the next five years.



A tool kit to close California's housing gap: 3.5 million homes by 2025 (October 2016)

Developing and advanced economies alike struggle with the dual challenges of housing their poorest citizens and providing housing at a reasonable cost for middle-income households. This paper looks specifically at the US state of California and offers remedies for fixing the chronic housing shortage.



Financing change: How to mobilize private-sector financing for sustainable infrastructure (March 2016)

Sustainable projects will add trillions to the world's infrastructure costs. McKinsey estimates that an additional 6 percent in up-front capital will be required to raise the level of new infrastructure to sustainability standards. Private-sector financing will be crucial.



Beating the low-productivity trap: How to transform construction operations (July 2016)

Engineering and construction firms are struggling with stagnating productivity and low profit margins in many markets. But they could achieve 20 to 30 percent operating margins if they were to design their operations differently and focus not only on utilization but also on profitability.



A blueprint for addressing the affordable housing challenge (October 2014)

A third of urban dwellers—1.6 billion people—could struggle to secure decent housing by 2025. This report offers four approaches that could help.



Bridging global infrastructure gaps (June 2016)

Global infrastructure systems are straining to meet demand, but the current spending trajectory will lead to worsening gaps. The world today invests some \$2.5 trillion a year in transportation, power, water, and telecommunications systems, but it is not enough. Yet there are solutions to unlock financing and make the sector more productive.



Infrastructure productivity: How to save \$1 trillion a year (January 2013)

Just keeping pace with projected global GDP growth will require an estimated \$57 trillion in infrastructure investment between now and 2030. Best practices, such as improving the selection of projects, streamlining their delivery, and making the most of existing infrastructure, could raise infrastructure productivity and save as much as \$1 trillion a year if scaled up globally.

www.mckinsey.com/mgi

E-book versions of selected MGI reports are available at MGI's website, Amazon's Kindle bookstore, and Apple's iBooks Store.



Download and listen to MGI podcasts on iTunes or at www.mckinsey.com/mgi/publications/multimedia/

Cover image © Stephen Simpson/Getty Images.

Contents page images: Workers carrying wood at construction site © DreamPictures/Getty Images; male architect and tradesman © Hero Images/Getty Images; assembling a prefab home © AContadini/Getty Images.



McKinsey Global Institute
February 2017
Copyright © McKinsey & Company
www.mckinsey.com/mgi

 @McKinsey_MGI
 McKinseyGlobalInstitute